



Palmako

LEMEKS GROUP

2025

Bringing joy to the garden

Over 700 high-quality wooden
products by Palmako



Isabella 14,7 m²

Dear Customer,

Life around us may change, but there are certain things in our lives that stay the same. There might be bad weather, lazy days feeling like doing nothing, communication errors, exhausting workdays or anything else that needs firmly our attention, our home and garden still need to be taken care of after all.

Gardens are one of many opportunities to express ourselves, it combines our hobbies in a best way for us. The only thing we need to do is understand what we want, what we need, what matters to us in the garden. Being outside and breathing fresh air is a great benefit.

Thinking about your garden, does it need a makeover or some update? We can help with that. Palmako's product range is very wide, starting from classical garden houses until modern cabins with sliding doors and finishing with saunas, sheds, garages, carports, fence panels, garden furniture and many more products to discover.

Maybe you need a new pavilion with a panoramic view out of the windows where you can eat dinners or lunch in spring or summer with your loved ones, watching your kids playing in the playhouse or playground. Or are you dreaming of a cozy sauna evening in your garden? We have a wide range of different saunas to choose from. Does the old carport or garage need to be replaced with a newer one, or perhaps you need a bigger shed where you can store your things. Some flowerboxes on the terrace, bordering with elegant fence panels for more privacy give the final touch to your garden. We have all these products in our wide selection.

Perhaps you have noticed that the catalogue in your hands is quite heavy. Our product range is very wide, this is why we have organized our products by categories on the side of the catalogue so you can

easily find what you are looking for. Our products are made of the finest Nordic spruce, which is known worldwide for its excellent properties. As wood is a renewable material, binding into it a remarkable quantity of CO² while growing, then by purchasing our products you are helping to support sustainable environmental-friendly attitudes and do at least a little good to our planet.

Wood is a natural material and to enjoy our products in the garden for a long time you will need to protect the wooden product against weather effects, wood-destroying fungi and insects. Therefore, we truly recommend using our product treatment service. Depending on the product type we are able to dip, pressure-treat or paint our products (initially in white or grey colours). Please read more about treatment possibilities on pages 362-368.

We continually appreciate your feedback regarding our products and services and we are eager to know how you have used them. You are welcome to share your ideas, proposals and photos via social media with [#palmako](#) [#bringjoytothegarden](#) or share them privately with us by sending an e-mail to palmako@palmako.ee or via our homepage www.palmako.ee.

We wish all our customers and consumers an exciting and productive 2025!

Ingrid Lamp
Marketing Manager



The joy of being in the garden

The garden – our connection with nature

We live our lives at crazy speeds amid droves of people and every day we become increasingly more alienated from nature. Going outdoors takes time and money and is an all around taxing experience. However, our ancient selves don't want to stop smelling the grass in the morning or seeing the light of the setting sun through tree branches. When we go back to the past along this line of heritage, we quickly reach our predecessors, who were peasants,

cattle breeders or hunters. Urbanisation is a new phenomenon in human history. A garden is often our last direct point of contact with nature, a reminder of the unity our predecessors felt with the surrounding environment. This feeling is deeply rooted in our subconscious and it makes the existence of a garden and time spent there so important for us.

The joy of being in the garden

We all strive to achieve ever-greater quality of life. Constantly juggling mountains of work and the need to spend time with our family forces us to look for balance between home and office, between reaping and sowing. It motivates us to emphasise our presence.

Our restless spirit and modern life force us out of our comfort zone – searching for greater value in life through social interaction and self-realisation.

Palmako doesn't build an artificial world with fake emotion and fake people. In the shape of the garden, Palmako extends quality living space, making it a special place in people's lives. Somewhere they live their real lives. A life which has meaning. Which is filled with quality time spent together, which we share with those closest to us. Somewhere we experience special moments.

We don't just make garden houses. We don't restrict ourselves to comprehensive garden solutions either.

We bring joy to the garden.

A garden is often our last direct point of contact with nature, a reminder of the unity our predecessors felt with the surrounding environment.



The many dimensions to garden life

The special moments in our lives are different and the roles gardens play in our lives are also different. A garden can be a place of relaxation where you hide from the world. Or it can be a meeting place where you discuss life with your loved ones. A garden can be the place where you devote yourself to your hobbies.

Every material has its character and soul. Wood is warm and beautiful and we understand its life cycle.

A beautiful garden can be our best feature for impressing neighbours and passers-by. It can also be a practical place for growing organic fruit and vegetables for our own use. We believe that quality time has many angles and colours, like an eventful life. We do not make decisions for garden owners; we simply do our best to turn their gardens into special places where moments are inspiring and different, just like people. The more varied our garden is the more joy it brings us.

Timeless garden wood

We have used wood to build our houses and gardens since ancient times and it has accompanied us throughout the centuries of our development. Every piece of wood has its own character and soul. Wood is warm and beautiful and we understand its life cycle. Like us, trees move in a circle of life, growing and living in the

time given to them. The constantly repeating cycle makes wood a renewable resource and using resources responsibly is increasingly more important in the context of growing environmental issues. Wood produced through correct and fair management is undoubtedly one of the best choices of our time. Wood is timeless – ancient and familiar on the one hand, and a building material with a clear future on the other.





Sarah 3,8+2,1 m²



Irene 19,0+33,2 m²

New this year

The way we need every now and then some new ideas or things in our lives, so too does your garden! Bringing into the garden something new, maybe rearranging it or adding a new product makes us value more the joy the garden brings. Our product development team has been working hard during the last years and has some new and exciting products to share with you.

To find new products quickly, just follow the sign „NEW!“ in brown squares next to the product and yellow circles in the index and check the product overview pages in front of every product category.

There are many newcomers in the Gable roof cabins category. The Irene family is complemented by the two new cabins with a large canopy roof in different sizes – **Irene 19,0+16,2 m²** and **Irene 19,0+33,2 m²**. The Claudia cabin family has grown by three new models - **Claudia 14,2 m²** and with a lower total height **Claudia Pent 11,5 m²** and **Claudia Pent 19,4 m²**. We also launched a new gable roof house family called Amanda! We have here Amanda houses with and without canopy roof – **Amanda 11,2 m²**, **Amanda 17,1 m²**, **Amanda 11,2+7,8 m²** and **Amanda 17,1+7,8 m²** – all available with single (Slide) and double glazing (Slide Plus).

The Andrea cabins in the Flat roof cabins section have now got a little sister called **Andrea 7,5 m² Slide Plus**. This cozy cabin has one sliding door with 4-16-4 mm toughened double glass.

Welcome also to our new pent roof family named Cecilia in the Cottages category – **Cecilia 14,2 m²**, **Cecilia 21,8 m²**, **Cecilia 27,2 m²**, **Cecilia 30,0 m²** and **Cecilia 32,0 m²**, all available with 4-16-4 mm toughened double glass (Slide Plus). The doors and windows of Cecilia houses are from aluminium, colour RAL7016.

We have added **Melanie Low 7,0 m²** to our Pavilions series. with a lower total height than the other Melanies have. If you have been missing bright and spacious pavilions with aluminium doors and windows, have a look at our new Isabella family – **Isabella 10,9 m²**, **Isabella 14,7 m²** and **Isabella 22,2 m²**. The dark grey colour of the doors and windows suits well with any treatment.

The Sanna sauna family in the Garden Spa section has now a new model **Sanna 11,5 m²**. As of this year our Garden Spa category is complemented with modern cubic saunas – **Grace Sauna 5,3 m²** and **Grace Sauna 8,2 m²**. These glue laminated wall panel saunas have aluminium doors and windows with smokey glass. We surprise you with another sauna – **Sarah 3,8+2,1 m²**. This sauna cube with

aluminium windows and smokey glass suits well into a modern garden.

In the Palmako Connect product series there are now Bianca and Lenna pavilions with Slide Plus quality sliding doors - double toughened glass 4-16-4 mm.

The Roger family in the Garages section has widened by two new garages with large canopy roofs where to park your car or even two! Greet **Roger 19,0+16,2 m²** and **Roger 19,0+33,2 m²**, all available as kit without door, with wooden gate and with sectional door.

For a long time there has been no news in the Carports category. We have launched many new carports, starting from Roberts with new sizes – **Robert 23,1 m²** and **Robert 40,6 m²**. Some Robert and Karl carports are available now with a suitable shed! Have a look at all of them – **Robert 23,1 m² with shed** and **Karl 23,1 m² with shed** with one parking space, **Robert 40,6 m² with shed** and **Karl 23,1 m² with shed** with two parking spaces.















To meet the market demand of having a simple foldable kiosk that could be easily and quickly put together and disassembled, we have come out with a folding kiosk **Marian 6,2 m²**. This kiosk in the Shed category includes a waterproof PVC canvas as roof covering material.

Looking at the fence category, you will find a new fence element **Kamilla 10** and **gate**, both available as white painted. Have a look at also on the round fencing pages, we added new **Postsaver protected posts**, **Premium machine rounded posts and poles** with different diameters and lengths. In case you need **wooden screws with hot dip** heads to complete the assembling of fencing, we have these in our product range.

Among Gardening & Other category two new **log rolls with 50 mm diameter** are now available to bring more joy to you when gardening.

















For the first time in product development history we offer timber **foundation frames** cut to size, all in brown dip treatment, including metal adjustment brackets. Another news in the Optional Products category is a new **self-adhesive EPDM** – one side of this EPDM is fully adhesive. One roll is 1,5 m wide and 10 m long.

We welcome all the new products in our Palmako product family and hope you have a better overview of our news to start renewing your outdoor living area.

	PALMAKO KIDS	CHILDREN'S SWINGS, PLAYGROUNDS AND PLAYHOUSES	16
	PALMAKO CABINS	WIDE SELECTION OF GARDEN HOUSES	
		GABLE ROOF	40
		FLAT ROOF	78
	PALMAKO COTTAGES	LARGER WEEKEND HOUSES	104
	PALMAKO MODERN LOOK HOUSES	PREFABRICATED HOUSES WITH LAMINATED TIMBER WALL PANELS	126
	PALMAKO NORDIC & NORDIC+ HOUSES	PREFABRICATED HOUSES WITH ELEMENT THICKNESS OF 88 AND 160 MM	138
	PALMAKO PAVILIONS	PAVILIONS, GAZEBOS, GRILL KOTAS AND GLASSHOUSES	150
	PALMAKO GARDEN SPA	BARREL AND OVAL SAUNAS, LOG SAUNAS	172
	PALMAKO CONNECT	ITEMS TO COMBINE YOURSELF AND READY-MADE SETS	196
	PALMAKO GARAGES	GARAGES	256
	PALMAKO CARPORTS	CARPORTS	274
	PALMAKO SHEDS	TOOL SHEDS AND KIOSKS	284
	PALMAKO FENCE	FENCE PANELS, POSTS AND POLES, TERRACE FENCES, GATES	308
	PALMAKO FURNITURE, GARDENING & OTHER	WOODEN GARDEN FURNITURE	334
		FLOWERBOXES, LOG ROLLS, HEAT PUMP COVER	
	PALMAKO OPTIONAL PRODUCTS	OPTIONAL PRODUCTS	344

All orders placed with Palmako AS based on this product catalogue are subject to, and the resulting contracts of sale governed by, the General Terms and Conditions of Sale of Palmako AS as are in force at the relevant time (hereinafter the "Terms"). The Terms are accessible on the website of Palmako AS: www.palmako.ee

PRODUCT INDEX

Agneta 18,8+12,5 m ²	110	Bianca 16,6 m ² Set 110	210	Claudia 19,4 m ²	64
Agneta 18,8+28,8 m ²	111	Bianca 16,6 m ² Set 111	227	Claudia Pent 11,5 m ²	 65
Alice 4,7 m ²	82	Bianca 16,6 m ² Set 112	227	Claudia Pent 19,4 m ²	 65
Alice 6,1 m ²	82	Bianca 16,6 m ² Set 202 / Set 502	213	Dan 4,5 m ²	292
Alice 9,0 m ²	83	Bianca 16,6 m ² Set 203 / Set 503	214	Dan 7,5 m ²	292
Alice 11,0 m ²	83	Bianca 16,6 m ² Set 204 / Set 504	214	Dan 9,9 m ²	293
Amanda 11,2 m ² Slide / Slide Plus	 70	Bianca 16,6 m ² Set 205 / Set 505	215	Dan 14,7 m ²	293
Amanda 11,2+7,8 m ² Slide / Slide Plus	 71	Bianca 16,6 m ² Set 206 / Set 506	215	Edwin	343
Amanda 17,1 m ² Slide / Slide Plus	 72	Bianca 16,6 m ² Set 207 / Set 507	216	Elke	315
Amanda 17,1+7,8 m ² Slide / Slide Plus	 73	Bianca 16,6 m ² Set 208 / Set 508	216	Ella 6,9 m ²	84
Andre 21,5 m ²	269	Bianca 24,9 m ²	207	Ella 6,9+8,2 m ²	85
Andre 28,5 m ²	270	Bianca 24,9 m ² Set 209 / Set 509	218	Ella 6,9+10,0 m ²	85
Andre 44,7 m ²	271	Bianca 24,9 m ² Set 210 / Set 510	218	Ella 8,7 m ²	84
Andrea 11,2 m ² Slide / Slide Plus	96	Bianca 24,9 m ² Set 211 / Set 511	217	Ella 8,7+8,2 m ²	86
Andrea 11,2+7,9 m ² Slide / Slide Plus	97	Bianca 24,9 m ² Set 212 / Set 512	217	Ella 8,7+10,0 m ²	86
Andrea 17,1 m ² Slide / Slide Plus	98	Bianca 24,9 m ² Set 213 / Set 513	220	Ella 13,1 m ²	87
Andrea 17,1+7,9 m ² Slide / Slide Plus	99	Bianca 24,9 m ² Set 214 / Set 514	220	Ella 13,1+3,9 m ²	87
Andrea 7,5 m ² Slide Plus	 95	Bianca 24,9 m ² Set 215 / Set 515	222	Emilia 5,4 m ²	166
Anette 3,0+1,5 m ²	182	Bianca 24,9 m ² Set 216 / Set 516	223	Emilia 8,2 m ²	166
Anita 0,9 m ²	177	Bianca 24,9 m ² Set 217 / Set 517	224	Emilia 13,8 m ²	168
Anita 1,3+0,7 m ²	178	Bianca 24,9 m ² Set 218 / Set 518	224	Emilia 19,1 m ²	168
Anita 1,3+0,7 m ² with glass wall	179	Bianca 24,9 m ² Set 219 / Set 519	223	Emilia shed 4,0 m ²	167
Anita 1,6+0,7 m ²	180	Bianca 24,9 m ² Set 222 / Set 522	219	Emily 39,2 m ²	108
Anita 1,6+0,7 m ² with glass wall	181	Bianca 24,9 m ² Set 223 / Set 523	219	Emily 40,1+5,2 m ²	109
Anna 26,8 m ²	112	Bianca 33,2 m ² Set 220 / Set 520	225	Emma 4,6 m ²	52
Anna 26,8+1,9 m ²	113	Bianca 33,2 m ² Set 221 / Set 521	225	Emma 10,4 m ²	52
Annabel 13,4 m ² Slide	145	Bianca Apex	203	Emma 10,4+4,2 m ²	53
Annika 21,5 m ²	148	Bianca Extra roof	201	Emma 14,2 m ²	53
Aron	341	Birgit	319	Etta 13,6 m ²	144
Arthur	340	Bosse	21	Eva 8,7 m ²	169
Betty 9,0 m ²	160	Brenda	21	Eva 11,4 m ²	169
Betty 9,9 m ²	160	Bret 14,8 m ²	94	Felix 1,9 m ²	34
Betty 18,0 m ²	161	Bret 19,9 m ²	94	Foundation frames	 352
Betty 25,0 m ²	161	Britta 14,6 m ²	50	Grace 8,1+4,1 m ²	131
Bianca 8,3 m ²	206	Britta 17,5 m ²	50	Grace 8,1+8,1 m ²	131
Bianca 8,3 m ² Set 101	208	Britta 19,7 m ²	51	Grace 12,4+4,1 m ²	132
Bianca 8,3 m ² Set 102	209	Britta 22,3 m ²	51	Grace 14,5 m ²	133
Bianca 8,3 m ² Set 103	210	Cecilia 14,2 m ²	 117	Grace 11,2 m ² Slide Plus	134
Bianca 8,3 m ² Set 104	226	Cecilia 21,8 m ²	 119	Grace 11,2+8,2 m ² Slide Plus	135
Bianca 8,3 m ² Set 105	226	Cecilia 27,0 m ²	 120	Grace 14,1 m ² Slide Plus	136
Bianca 8,3 m ² Set 106	226	Cecilia 30,0 m ²	 121	Grace Sauna 5,3 m ²	 190
Bianca 8,3 m ² Set 201 / Set 501	213	Cecilia 32,0 m ²	 122	Grace Sauna 8,2 m ²	 191
Bianca 16,6 m ²	206	Charlotte 21,5 m ²	147	Grete 3,7 m ²	37
Bianca 16,6 m ² Set 107	208	Chick 6,7 m ²	288	Hanna 7,6 m ²	156
Bianca 16,6 m ² Set 108	208	Claudia 14,2 m ²	 63	Hanna 14,1 m ²	156
Bianca 16,6 m ² Set 109	209	Claudia 11,5 m ²	64	Hanna 20,3 m ²	157

Harry 3,1 m ²	39	Lenna 16,6 m ²	232	Pernilla 21,5 m ²	147
Hedwig 13,6 m ²	143	Lenna 16,6 m ² Set 307	234	Postsaver posts	332
Heidi 11,7 m ²	100	Lenna 16,6 m ² Set 308	234	Premium poles	333
Heidi 19,7 m ²	100	Lenna 16,6 m ² Set 309	235	Premium posts	332
Heidi 22,5 m ²	101	Lenna 16,6 m ² Set 310	236	Rasmus 19,0 m ²	260
Heidi 22,8 m ²	101	Lenna 16,6 m ² Set 311	253	Reena	314
Helena 15,1 m ²	56	Lenna 16,6 m ² Set 312	253	Robert 11,7 m ²	277
Helena 18,6 m ²	56	Lenna 16,6 m ² Set 402 / Set 702	239	Robert 20,6 m ²	277
Helena 24,6 m ²	57	Lenna 16,6 m ² Set 403 / Set 703	240	Robert 23,1 m ²	278
Helis	316	Lenna 16,6 m ² Set 404 / Set 704	240	Robert 40,6 m ²	279
Henry	20	Lenna 16,6 m ² Set 405 / Set 705	241	Robert 23,1 m ² with shed	278
Holger	20	Lenna 16,6 m ² Set 406 / Set 706	241	Robert 40,6 m ² with shed	279
Huck 3,3 m ²	38	Lenna 16,6 m ² Set 407 / Set 707	242	Roger 19,0 m ²	261
Ines 11,1 m ²	66	Lenna 16,6 m ² Set 408 / Set 708	242	Roger 19,0+16,2 m ²	266
Ines 11,1 m ² Slide / Slide Plus	67	Lenna 24,9 m ²	233	Roger 19,0+33,2 m ²	267
Ines 13,7 m ²	68	Lenna 24,9 m ² Set 409 / Set 709	244	Roger 23,9 m ²	262
Ines 13,7 m ² Slide / Slide Plus	69	Lenna 24,9 m ² Set 410 / Set 710	244	Roger 21,9+5,2 m ²	264
Irene 19,0 m ²	59	Lenna 24,9 m ² Set 411 / Set 711	243	Roger 27,7 m ²	263
Irene 19,0+16,2 m ²	61	Lenna 24,9 m ² Set 412 / Set 712	243	Roger 28,4 m ²	265
Irene 19,0+33,2 m ²	61	Lenna 24,9 m ² Set 413 / Set 713	246	Ruby 18	339
Irene 23,9 m ²	60	Lenna 24,9 m ² Set 414 / Set 714	246	Ruby 24	339
Irene 21,9+5,2 m ²	59	Lenna 24,9 m ² Set 415 / Set 715	248	Sally 10,2 m ²	54
Irene 27,7 m ²	60	Lenna 24,9 m ² Set 416 / Set 716	249	Sally 12,3 m ²	54
Iris 9,6 m ²	62	Lenna 24,9 m ² Set 417 / Set 717	250	Sally 15,5 m ²	55
Iris 11,1 m ²	62	Lenna 24,9 m ² Set 418 / Set 718	250	Sally 19,1 m ²	55
Iris 19,1 m ²	63	Lenna 24,9 m ² Set 419 / Set 719	249	Sam 2,4 m ²	33
Isabella 10,9 m ²	163	Lenna 24,9 m ² Set 422 / Set 722	245	Sandra 21,5+3,7 m ²	114
Isabella 14,7 m ²	164	Lenna 24,9 m ² Set 423 / Set 723	245	Sandra 25,6+11,1 m ²	115
Isabella 22,2 m ²	165	Lenna 33,2 m ² Set 420 / Set 720	251	Sandra 29,9 m ²	116
Janet	319	Lenna 33,2 m ² Set 421 / Set 721	251	Sandy 14	28
Jari 8,9 m ²	297	Lenna extra roof	201	Sandy 16	28
Jari 14,5 m ²	297	Leo	341	Sanna 4,1 m ²	184
Jennie 3,6 m ²	36	Line	312	Sanna 4,1+5,9 m ²	185
Jesper Bridge	25	Lisa 11,5 m ²	88	Sanna 6,8 m ²	186
Jesper Climbing wall	25	Lisa 14,2 m ²	88	Sanna 6,8+5,9 m ²	187
Jesper Set 1	26	Lisa 19,4 m ²	89	Sanna 11,5 m ²	188
Jesper Set 2	27	Lisbet	28	Sanna 12,8 m ² Slide / Slide Plus	189
Jesper Set 3	27	Log rolls	343	Sanne 18	338
Jesper Swing beam	24	Lotta 7,3 m ²	45	Sarah 3,8+2,1 m ²	192
Jesper Tower with roof	24	Lotta 10,0 m ²	45	Sigrid	338
Jonas	23	Lotta 13,9 m ²	46	Simone 13,6 m ²	144
Julie 10,5 m ²	162	Lovisa 10	323	Siri 6 glass	329
Kalev	22	Lovisa 10 gate	323	Siri 11	328
Kalle 6,6 m ²	301	Lucas 5,4 m ²	295	Siri 11 glass	329
Kalle 13,5 m ²	301	Lucas 12,1 m ²	295	Siri 17	328
Kalle 16,9 m ²	302	Lucy 12,2 m ²	162	Stella 5,0 m ²	303
Kamilla 10	325	Luise 10	324	Stella 8,2 m ²	303
Kamilla 10 gate	325	Luise 10 gate	324	Stig 8,2 m ²	296
Karina	318	Ly 13,6 m ²	143	Stina 3,1 m ²	33
Karl 11,7 m ²	280	Magnus	19	Susanna 12,4 m ²	58
Karl 20,6 m ²	280	Marcus 6,5 m ²	296	Susanna 16,4 m ²	58
Karl 23,1 m ²	281	Marian 6,2 m ² - Folding kiosk	304	Toby 2,1 m ²	34
Karl 40,6 m ²	282	Marie 5,4 m ²	37	Toby Set	35
Karl 23,1 m ² with shed	282	Marit	317	Toby Swing beam	35
Karl 40,6 m ² with shed	282	Martin 8,4 m ²	298	Tom 3,8 m ²	38
Kasper	22	Martin 13,6 m ²	299	Valentine 4,7 m ²	48
Kelda 8	326	Mathias	19	Valentine 6,1 m ²	48
Kelda 8 gate	326	Melanie 6,9 m ²	154	Valentine 9,0 m ²	49
Kelda 10	327	Melanie 7,0 m ²	153	Valentine 11,0 m ²	49
Kelda 10 gate	327	Melanie Low 7,0 m ²	153	Veronica 2 6,7 m ²	158
Kendra 18,4 m ²	107	Melanie 9,9 m ²	154	Veronica 4 6,7 m ²	158
Kira 7,7 m ²	302	Melanie 7,0+8,1 m ²	155	Veronica 4 9,2 m ²	159
Klara 4,7 m ²	46	Melissa 4	342	Veronica 7 9,2 m ²	159
Klara 10,4 m ²	47	Melissa 7	342	Vivian 3,8 m ²	44
Klara 17,0 m ²	47	Melissa 10	342	Vivian 6,9 m ²	44
Laureen	330	Merit	23		
Lea 14,2 m ²	90	Mia 3,6 m ²	289		
Lea 14,2 m ² Slide / Slide Plus	91	Mia 5,4 m ²	289		
Lea 19,4 m ²	92	Nils 5,4 m ²	294		
Lea 19,4 m ² Slide / Slide Plus	93	Nils 8,2 m ²	294		
Leif 2,2 m ²	290	Nina	313		
Leif 3,0 m ²	290	Olaf 6,6 m ²	299		
Leif 3,0+2,9 m ²	291	Olaf 13,5 m ²	300		
Leif 4,5 m ²	290	Olaf 16,9 m ²	300		
Leif 4,5+2,9 m ²	291	Oscar	340		
Lenna 8,3 m ²	232	Otto 3,6 m ²	36		
Lenna 8,3 m ² Set 301	234	Palmako Connect Fence	203		
Lenna 8,3 m ² Set 302	235	Palmako Connect Floor (indoor)	203		
Lenna 8,3 m ² Set 303	236	Palmako Connect Floor (outdoor)	203		
Lenna 8,3 m ² Set 304	252	Palmako Connect Full wall	202		
Lenna 8,3 m ² Set 305	252	Palmako Connect Half-wall corner	202		
Lenna 8,3 m ² Set 306	252	Palmako Connect Louvre wall	202		
Lenna 8,3 m ² Set 401 / Set 701	239	Palmako Connect Wall with hatch	202		

Palmako is a part of the Lemeks Group

Lemeks AS was founded in 1993 with an aim of creating a modern forest stocking company systematically covering the whole country and on the basis of which a timber industry could be established that values local timber.

Today the Lemeks Group has developed into the biggest forestry company in Estonia that is funded by Estonian capital and operates successfully in the sphere of timber processing and forest stocking as well as in agriculture.

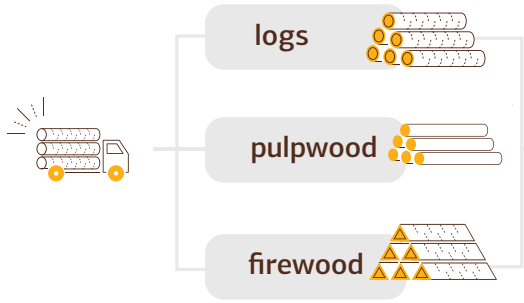

Timber value-added chain

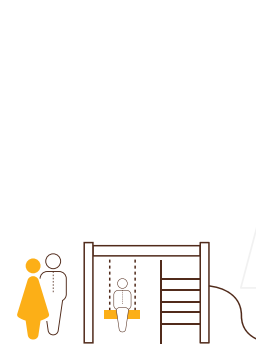
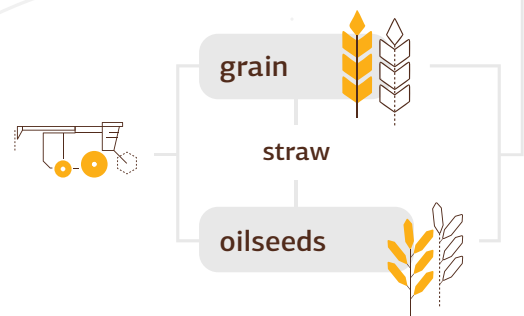

35 subsidiaries and related companies provide employment to more than 1000 people in Estonia, Latvia, Germany, Sweden, Norway, France, Spain, United Kingdom and the United States of America. Belonging to the Lemeks Group provides Palmako support in financial management and IT. It also gives an excellent opportunity to share valuable information and experience with other specialists in the same field. The existence of belonging to the group's value chain ensures the supply of raw material even during harder times.

More about the Lemeks Group on the website

www.lemeks.ee

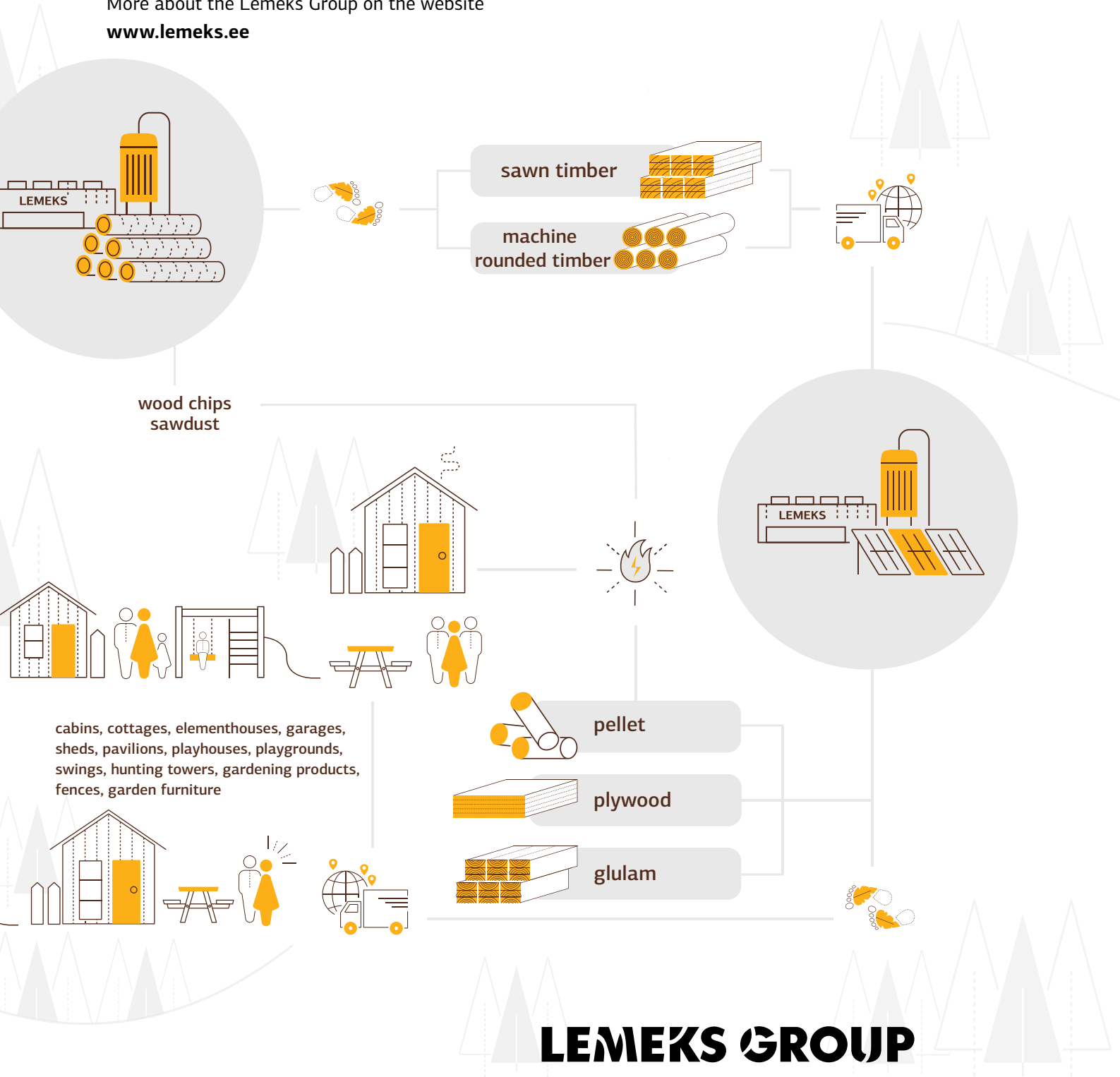

LEMEXS GROUP

About us

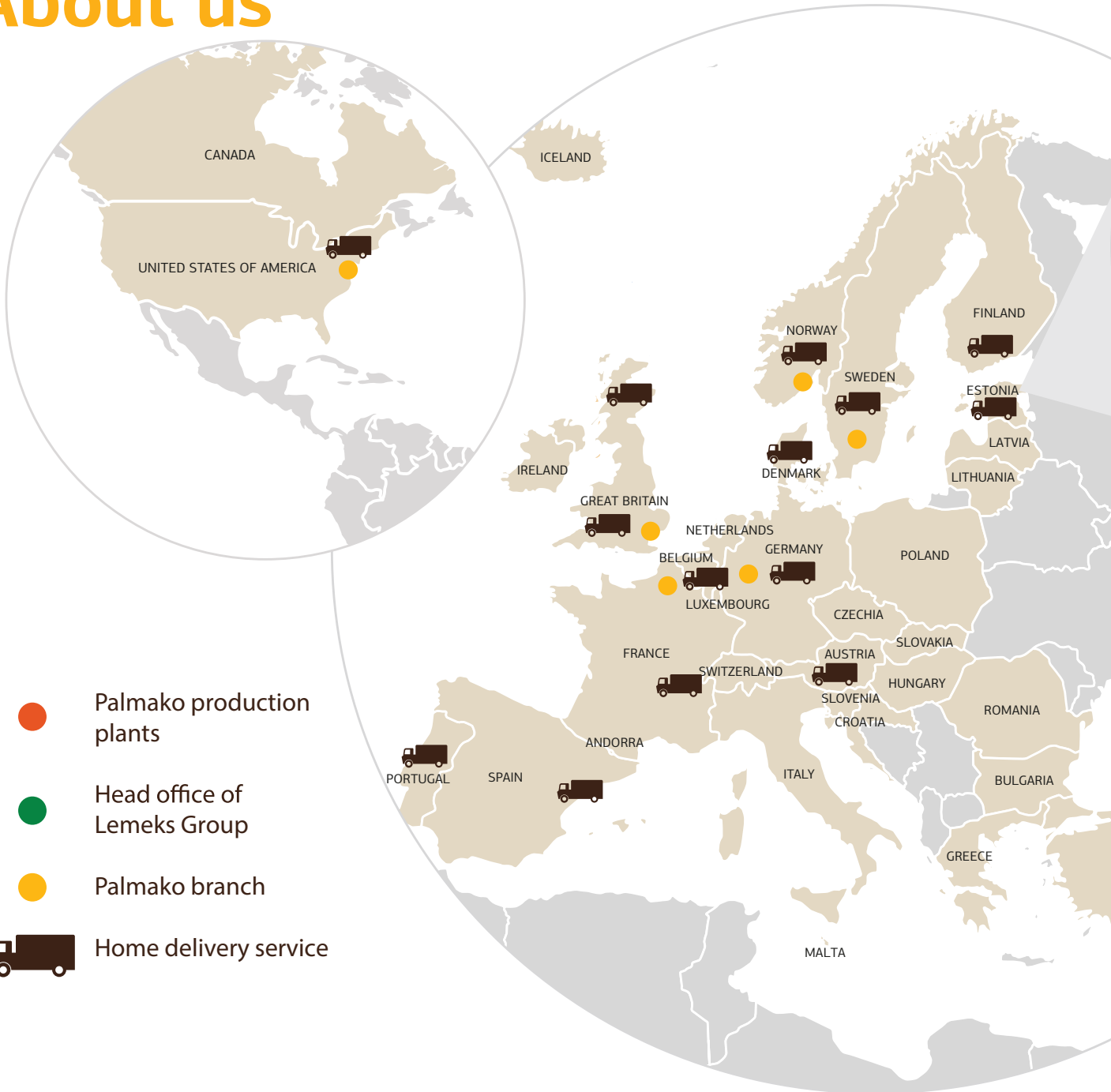

- Palmako production plants
- Head office of Lemeks Group
- Palmako branch
- Home delivery service

Principles that we follow in our everyday work:

- We are honest
- We are goal-oriented
- We are open to changes
- We are willing to take responsibility
- We respect our partners
- We assess our colleagues by their results, not by their words
- We share our knowledge and skills with each other
- We aim to do, rather than impress

We have invested over 50 million euros in modern, professional technology, which has enabled us to use the best machinery to make our products.

Leading manufacturer in Europe

Palmako produces and exports over 60,000 wooden houses per year, and 27 years of active operation have given us significant experience to become Northern Europe's leading manufacturer and distributor of square log garden houses.



Scan this QR-code to see a video how our products are made with utmost care!

Social responsibility

Although wood is a sustainable and regenerative natural resource, forestry requires careful and responsible management. An uncaring and irresponsible attitude towards forestry management will inevitably harm our environment significantly. We all have heard stories about the loss of some rainforests, but this concern applies equally to our Nordic forests as well. Palmako is FSC® certified, ensuring that we use wood from responsibly managed forests. We care about the environment, which we share and in which we all live. We really do.

5-year warranty

Over the last 27 years we have produced over half a million wooden houses. We use only the latest technology to make no compromises on quality, and to make sure that the nature and its resources are handled in the best possible way. We really care about the environment that we all share. We hope that already offers a reason to trust us, but we also place a 5-year warranty on our buildings if they are treated according to recommendations. Playgrounds and swings have 2-year warranty for your complete peace of mind.

Excellent customer service

We keep stock of our re-sellers to ensure fast, precise deliveries throughout Europe, and we are ready to deliver our products directly to the end customer's if required. As a multilingual company, we can service our customers in 8 different languages – English, German, French, Spanish, Finnish, Swedish and Norwegian as well as Estonian.

Nordic spruce

Wood is an impressive, warm and living material. And nothing compares to the wonderful aroma of fresh timber. During the long, cold winters the trees grow slowly, which makes their timber especially thick and durable. You can feel it in all our products - comfortable garden and log houses, pavilions, carports, tool sheds, children's play houses, weekend and living houses, glue-laminated products, and wood pellets.



In addition to log cabins, Palmako manufactures wide selection of garden products, glulam products and heating pellets.

Estonia is regarded as the biggest wooden house exporter in the Europe. Palmako plays a significant part in this. Our products are found in more than 30 countries around the world.



Look for FSC® certified products.

2025 Catalogue User Guide

Parts of the catalogue



Introductory pages, where you can find information about us, **p. 1-11**



Products, divided into classes according to their **function**, **p. 16-343**



Information about how to navigate products' pages, **p. 12-15**



Optional products, list of all those that Palmako offers, **p. 344-368**

Special pages:

p. 123	quote request for cottages	p. 183	introduction to log saunas
p. 128	Modern Look houses introduction	p. 193-194	introduction to sauna heaters
p. 140-141	Nordic houses introduction and information on assembly	p. 198-199	Palmako Connect introduction
p. 146	Nordic+ houses introduction	p. 268	Nordic+ garages introduction
p. 174-175	introduction to barrel and oval saunas	p. 320-321	introduction to fence series
		p. 364-367	overview of painting the cabins

Structure of products' pages

FUNCTION

All our products are organised into separate classes according to their function and each class begins with an overview of all the items that it includes.



Cabins:
outbuilding and leisure



Pavilions:
Outdoor leisure



Fences:
Fence panels

TYOLOGY

Products of the same type and purpose carry the same name.

In each class products have been assembled into smaller families according to their design.

Families are made up of products that carry similar external characteristics, like type of roof, door and window type and placement, terrace and overhang of the front roof.



Gable roof



Flat roof



Pent roof

Helena cabin family



Irene cabin family



Lotta cabin family



SIZE

Under each family the products are presented in the order of ascending surface area with increasing wall thickness and in some cases improvement of the quality of doors and windows.



15,1 m²
Palmako cabin
Helena



18,6 m²
Palmako cabin
Helena



24,6 m²
Palmako cabin
Helena

How to read product information

Name of the product

We have put a lot of thought into naming our products and as a result, the name of the chosen product reflects its function, family and size (also additional area when a terrace or side roof is included).

BRAND - **Palmako** > FUNCTION - **cabin** > FAMILY - **Lisa** > SIZE - **surface area 11,5 m²**

Product information

Each page contains one or two of our products with all the information about it listed as symbols or as text. This example below will help you read and understand product information better.

PALMAKO CABIN LISA 11,5 m²

NEW! - This is a new product
under 2,5m - Height of product is under 2,5 meters

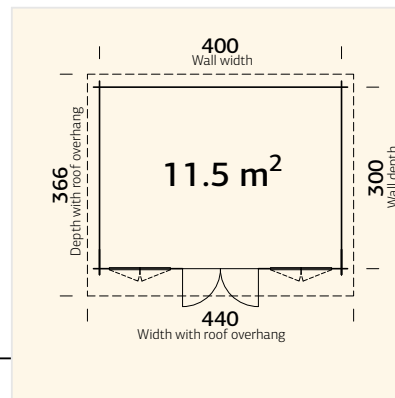

Groundplan

Specifications for the specific model

MODEL SPECIFICATIONS

Log measurements: 420x320 cm	Door opening measurements: 114x186 cm
Volume: 25,6 m ³	Door sill: low, covered with stainless steel
Door/window type: Garden	Roof boards : 19 mm
Window glass: Real glass, 4 mm	Roof area: 16,1 m ²
Door glass: Toughened glass, 4 mm	Roof gradient: 4,4°
Window opening measurements: 90x123 cm	Gross ground area: 12,0 m ²

How the specific model can be treated

TREATMENT

Available dipped
 Available painted

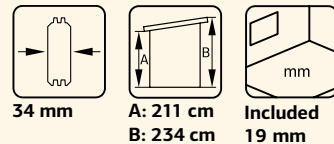

Optional products for the specific model

General information described with symbols

OPTIONAL

Roofing felt (underlayer): 3 rolls, SBS roofing material: 3 rolls, roofing nails, EPDM, rain gutters, extension, canopy roof, additional door and window.

Description of the symbols

							Floor boards
							Wood profile
							Age/Weight limit

Wall/element/post thickness

Heights (A - wall height; B - total height)

Optional products

At the end of each product class we have presented a table showing additional opportunities to personalise and style your chosen product, like canopy roof, extension, different roof covering materials, rain gutters, additional doors and

windows and their types, etc. A more detailed list with pictures can be found at the end of the catalogue, under the Palmako Optional Products category.

Sally 15,5 m² basic model

BEFORE



Sally 15,5 m² with optional products

AFTER

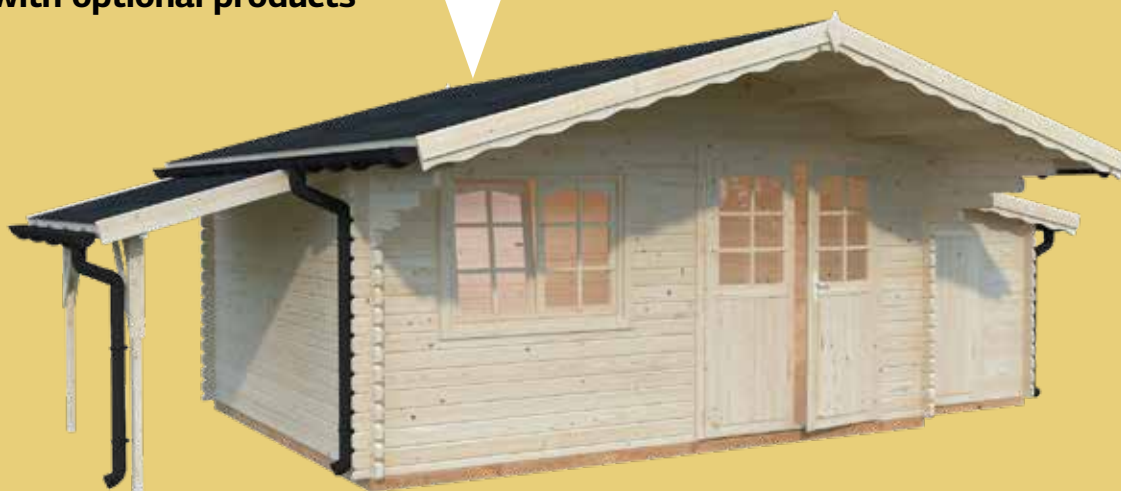



Toby Set

A wooden playhouse with a black roof, a red slide, and two swings is situated in a lush green forest. The playhouse has a balcony with a railing and a ladder leading up to it. A pink toy car is parked on the ground in the foreground. The scene is set on a bed of wood chips, with a large tree trunk on the left and a large rock in the foreground.

KIDS



PALMAKO KIDS
MATHIAS



PALMAKO KIDS
MAGNUS



PALMAKO KIDS
HOLGER



PALMAKO KIDS
HENRY



PALMAKO KIDS
BRENDA



PALMAKO KIDS
BOSSE



PALMAKO KIDS
KALEV



PALMAKO KIDS
KASPER



PALMAKO KIDS
MERIT



PALMAKO KIDS
JONAS



PALMAKO KIDS
JESPER TOWER WITH ROOF



PALMAKO KIDS
JESPER SWING BEAM



PALMAKO KIDS
JESPER CLIMBING WALL



PALMAKO KIDS
JESPER BRIDGE



PALMAKO KIDS
JESPER SET 1



PALMAKO KIDS
JESPER SET 2



PALMAKO KIDS
JESPER SET 3



PALMAKO KIDS
LISBET



PALMAKO KIDS
SANDY 14



PALMAKO KIDS
SANDY 16

PALMAKO KIDS MATHIAS



MODEL SPECIFICATIONS

Length: 310 cm

Width: 194 cm

Safety area: 730x750 cm

Diameter of swing

beam: 100 mm

Diameter of swing legs: 80 mm

On-the-ground product

TREATMENT



green pressure-treated

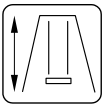

230 cm



3-14 years
max 50 kg



Roundwood



ADDITIONAL

Anchors x4.

PALMAKO KIDS MAGNUS



MODEL SPECIFICATIONS

Length: 380 cm

Width: 194 cm

Safety area: 790x800 cm

Diameter of

swing beam: 100 mm

Diameter of

swing legs: 80 mm

On-the-ground product

TREATMENT



green pressure-treated

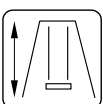

230 cm



3-14 years
max 50 kg



Roundwood



ADDITIONAL

Anchors x4.

PALMAKO KIDS HOLGER

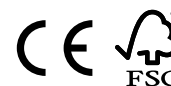

MODEL SPECIFICATIONS

- Length:** 360 cm
- Width:** 195 cm
- Safety area:** 770x880 cm
- Diameter of swing beam:** 100 mm
- Measurements of swing legs:** 80/64 mm
- Platform height for slide:** 146 cm

On-the-ground product
NB! Slide is an optional extra!

TREATMENT



green pressure-treated

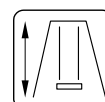

230 cm

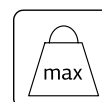

3-14 years
max 50 kg



Minisleeper



ADDITIONAL

Anchors x6, slide.

PALMAKO KIDS

16-39

PALMAKO KIDS HENRY

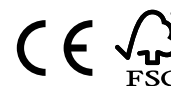

MODEL SPECIFICATIONS

- Length:** 440 cm
- Width:** 200 cm
- Safety area:** 850x880 cm
- Diameter of swing beam:** 100 mm
- Measurements of swing legs:** 100/80 mm
- Platform height for slide:** 146 cm

On-the-ground product
NB! Slide is an optional extra!

TREATMENT



green pressure-treated

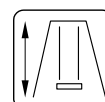

230 cm

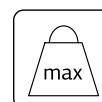

3-14 years
max 50 kg



Minisleeper



ADDITIONAL

Anchors x6, slide.

PALMAKO KIDS BRENDA



MODEL SPECIFICATIONS

- Length:** 510 cm
- Width:** 195 cm
- Safety area:** 920x880 cm
- Diameter of swing beam:** 100 mm
- Measurements of swing legs:** 80/64 mm
- Platform height for slide:** 146 cm

On-the-ground product
 NBI Slide is an optional extra!



TREATMENT



green pressure-treated

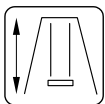

230 cm



3-14 years
max 50 kg



Minisleeper

ADDITIONAL

Anchors x6, slide.

PALMAKO KIDS BOSSE



MODEL SPECIFICATIONS

- Length:** 445 cm
- Width:** 200 cm
- Safety area:** 850x880 cm
- Diameter of swing beam:** 100 mm
- Measurements of swing legs:** 100/80 mm
- Platform height for slide:** 146 cm

On-the-ground product
 NBI Slide is an optional extra!



Scan this QR-code to see assembly of Bosse playground!

TREATMENT



brown pressure-treated

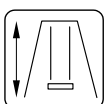

230 cm



3-14 years
max 50 kg



Minisleeper

ADDITIONAL

Anchors x6, slide.

PALMAKO KIDS KALEV



MODEL SPECIFICATIONS

- Length:** 470 cm
- Width:** 200 cm
- Safety area:** 870x880 cm
- Diameter of swing beam:** 100 mm
- Measurements of swing legs:** 100/80 mm
- Platform height for slide:** 146 cm

On-the-ground product
NB! Slide is an optional extra!

TREATMENT



green pressure-treated

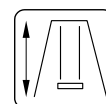

230 cm



3-14 years
max 50 kg



Minisleeper



ADDITIONAL

Anchors x6, slide.

PALMAKO KIDS KASPER



MODEL SPECIFICATIONS

- Length:** 366 cm
- Width:** 200 cm
- Safety area:** 880x770 cm
- Diameter of swing beam:** 100 mm
- Measurements of swing legs:** 100/80 mm
- Platform height for slide:** 146 cm

On-the-ground product
NB! Slide is an optional extra!

TREATMENT



green pressure-treated

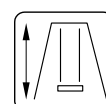

230 cm



3-14 years
max 50 kg



Minisleeper



ADDITIONAL

Anchors x6, slide.

PALMAKO KIDS MERIT

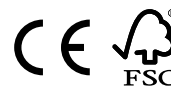

MODEL SPECIFICATIONS

- Length:** 352 cm
- Width:** 204 cm
- Safety area:** 852x894 cm
- Diameter of swing beam:** 100 mm
- Diameter of swing legs:** 100 mm



In-the-ground product

TREATMENT



green pressure-treated

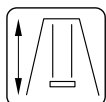

220 cm



3-14 years
max 50 kg



Roundwood

PALMAKO KIDS JONAS

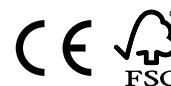

MODEL SPECIFICATIONS

- Length:** 306 cm
- Width:** 208 cm
- Safety area:** 706x700 cm
- Measurements of swing beam:** 90x90 mm, glued laminated wood
- Measurements of swing legs:** 70x70 mm
- Platform height for slide:** 120 cm



On-the-ground product

NB! Slide is an optional extra!

TREATMENT



brown pressure-treated

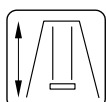

219 cm



3-14 years
max 50 kg

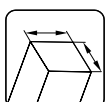

Square wood



ADDITIONAL

Anchors x6, slide.

PALMAKO KIDS JESPER TOWER WITH ROOF



MODEL SPECIFICATIONS

- Length:** 120 cm
- Width:** 120 cm
- Safety area:** 520x605 cm
- Measurements of legs:** 70x70 mm
- Platform height for slide:** 120 cm



On-the-ground product.
NB! Slide is an optional extra!

TREATMENT



brown pressure-treated

ADDITIONAL

Anchors x4, slide.

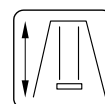

314 cm



3-14 years
max 50 kg

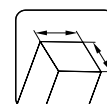

Square wood



PALMAKO KIDS JESPER SWING BEAM



MODEL SPECIFICATIONS

- Length:** 241 cm
- Width:** 208 cm
- Safety area:** 445x700 cm
- Measurements of swing beam:** 90x90 mm, glued laminated wood
- Measurements of swing legs:** 70x70 mm



On-the-ground product.

TREATMENT



brown pressure-treated

ADDITIONAL

Anchors x2.

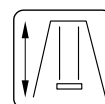

214 cm



3-14 years
max 50 kg

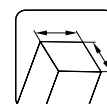

Square wood



PALMAKO KIDS JESPER CLIMBING WALL



Safety
Regular
Production
Surveillance

www.tuv.com
ID 0000085235

MODEL SPECIFICATIONS

Length: 102 cm

Width: 11 cm

Height: 138 cm

TREATMENT



brown pressure-treated



3-14 years
max 50 kg

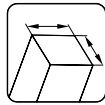

Square wood

PALMAKO KIDS JESPER BRIDGE



Safety
Regular
Production
Surveillance

www.tuv.com
ID 0000085235

MODEL SPECIFICATIONS

Length: 235 cm

Width: 116 cm

Height: 89 cm

TREATMENT



brown pressure-treated



3-14 years
max 50 kg

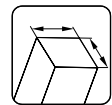

Square wood



Jesper Set 1

You can combine different parts of the Jesper playground by yourself or choose one of our ready-made sets that we have created for your convenience.



PALMAKO KIDS JESPER SET 1

2 TOWERS WITH ROOF +
BRIDGE +
CLIMBING WALL +
SWING BEAM



MODEL SPECIFICATIONS

- Length:** 600 cm
- Width:** 464 cm
- Safety area:** 1000x865 cm
- Measurements of swing beam:** 90x90 mm, glued laminated wood
- Measurements of swing legs:** 70x70 mm
- Platform height for slide:** 120 cm

On-the-ground product
NB! Slide is an optional extra!

TREATMENT



brown pressure-treated



ADDITIONAL

Anchors x10, slide.

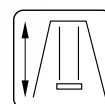

314 cm



3-14 years
max 50 kg

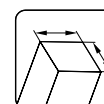

Square wood

PALMAKO KIDS JESPER SET 2 TOWER WITH ROOF + SWING BEAM



MODEL SPECIFICATIONS

- Length:** 366 cm
- Width:** 305 cm
- Safety area:** 766x866 cm
- Measurements of swing beam:** 90x90 mm, glued laminated wood
- Measurements of swing legs:** 70x70 mm
- Platform height for slide:** 120 cm

On-the-ground product
 NB! Slide is an optional extra!

TREATMENT



brown pressure-treated



314 cm **3-14 years** **Square wood**
 max 50 kg

ADDITIONAL

Anchors x6, slide.



PALMAKO KIDS JESPER SET 3 TOWER WITH ROOF + CLIMBING WALL + SWING BEAM



MODEL SPECIFICATIONS

- Length:** 361 cm
- Width:** 304 cm
- Safety area:** 761x704 cm
- Measurements of swing beam:** 90x90 mm, glued laminated wood
- Measurements of swing legs:** 70x70 mm
- Platform height for slide:** 120 cm

On-the-ground product
 NB! Slide is an optional extra!

TREATMENT



brown pressure-treated



314 cm **3-14 years** **Square wood**
 max 50 kg

ADDITIONAL

Anchors x6, slide.



PALMAKO KIDS
 16-39

PALMAKO KIDS SANDY 14 / 16

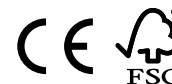

PALMAKO KIDS

16-39



MODEL SPECIFICATIONS

Length: 137 cm / 157 cm

Width: 137 cm / 157 cm

On-the-ground product
With foldable cover.

OPTIONAL

Underlayer for sandbox.

TREATMENT



green pressure-treated

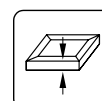

21 cm



3-14 years
max 50 kg



Boards

PALMAKO KIDS LISBET



MODEL SPECIFICATIONS

Length: 90 cm

Width: 89 cm

Height: 50 cm

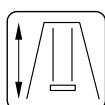
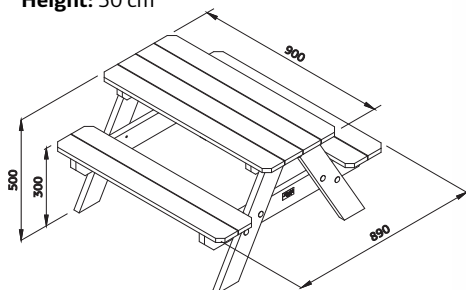

50 cm



3-14 years
max 50 kg



Boards

TREATMENT



primer + white painted 2 layers (RAL 9016)

OPTIONAL PRODUCTS



SWING SEAT
441 x 170 x 85 mm
Art. No.: 101000



BABY SEAT
320 x 300 x 260 mm
Art. No.: 100999



SLIDE
for 120 cm platform
495 x 2300 mm
Art. No.: 101004, 107382



SLIDE
for 150 cm platform
495 x 2900 mm
Art. No.: 101006, 101005, 101007



NEST SWING SWIBEE
ø 980 mm
Art. No.: 100245, 100246



MONKEY SWING
ø 280 mm
Art. No.: 107393



SWING CLAMP
ø 100 mm
Art. No.: 101001



SWING CLAMP (THROUGH WOOD)
ø 120 mm
Art. No.: 108274



F-ANCHOR
50 x 500 mm
Art. No.: 100997



SWING CLAMP
90 x 90 mm
Art. No.: 108275



UNDERLAYER FOR SANDBOX
Art. No.: 107502



CLIMBING STONES
5 pcs/pack
Art. No.: 107398



ROPE LADDER
Art. No.: 107397

OPTIONAL PRODUCTS

SEE OPTIONAL PRODUCTS, PAGES 344-368

Product	Art. No.	Slide for 150 cm platform	Slide for 120 cm platform	Swing seat	Baby seat	Monkey swing	Nest swing Swibee (blue, green)	Rope ladder	Swing clamp ø 100 mm	Swing clamp (through wood) ø 120 mm	Swing clamp 90 x 90 mm	F-Anchor 50x500 mm	Underlayer for sandbox	Climbing stones
Mathias	103645				100999	107393	100245, 100246 *	107397	101001			100997 4 pieces		
Magnus	107247				100999	107393	100245, 100246 *	107397	101001			100997 4 pieces		
Holger	107260	101005, 101006, 101007 *		101000	100999	107393	100245, 100246 *	107397	101001			100997 6 pieces		
Henry	103639	101005, 101006, 101007 *			100999	107393	100245, 100246 *	107397	101001			100997 6 pieces		
Brenda	107261	101005, 101006, 101007 *			100999	107393	100245, 100246 *	107397	101001			100997 6 pieces		107398
Bosse	103656	101005, 101006, 101007 *			100999	107393	100245, 100246 *	107397	101001			100997 6 pieces		107398
Kalev	103642	101005, 101006, 101007 *										100997 6 pieces		
Kasper	107465	101005, 101006, 101007 *										100997 6 pieces		
Merit	107597							107397						107398
Jonas	109516	101005, 101006, 101007, 101004, 107382												100997 6 pieces

* Ask for availability of different colour options.
Table includes optional products that are not included in set of swing or playground. We offer more optional products so your children can have more fun while playing.

OPTIONAL PRODUCTS

SEE OPTIONAL PRODUCTS, PAGES 344-368

Product	Art. No.	Slide for 150 cm platform	Slide for 120 cm platform	Swing seat	Baby seat	Monkey swing	Nest swing Swibee (blue, green)	Rope ladder	Swing clamp ø 100 mm	Swing clamp (through wood) ø 120 mm	Swing clamp 90 x 90 mm	F-Anchor 50x500 mm	Underlayer for sandbox	Climbing stones
Jesper Tower with Roof	109512		101004, 107382									100997 4 pieces		
Jesper Climbing wall	109514													107398
Jesper Set 1	109500		101004, 107382									100997 10 pieces		107398
Jesper Set 2	109502		101004, 107382									100997 6 pieces		
Jesper Set 3	109496		101004, 107382									100997 6 pieces		107398
Sandy 14	103629												107502	
Sandy 16	103633												107502	

* Ask for availability of different colour options.
Table includes optional products that are not included in set of swing or playground. We offer more optional products so your children can have more fun while playing.

KIDS



PALMAKO KIDS
SAM 2,4 m²



PALMAKO KIDS
STINA 3,1 m²



PALMAKO KIDS
FELIX 1,9 m²



PALMAKO KIDS
TOBY 2,1 m²



PALMAKO KIDS
TOBY SWING BEAM



PALMAKO KIDS
TOBY SET



PALMAKO KIDS
OTTO 3,6 m²



PALMAKO KIDS
JENNIE 3,6 m²



PALMAKO KIDS
GRETE 3,7 m²



PALMAKO KIDS
MARIE 5,4 m²



PALMAKO KIDS
TOM 3,8 m²



PALMAKO KIDS
HUCK 3,3 m²



PALMAKO KIDS
HARRY 3,1 m²

PALMAKO KIDS SAM 2,4 m²

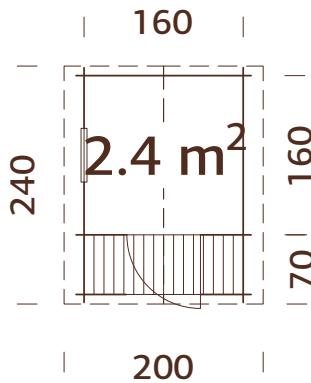

PALMAKO KIDS
16-39

MODEL SPECIFICATIONS

Log measurements:

176x176(236) cm

Volume: 4,1 m³

Door/window glass:

Acrylglass

Fixed window

measurements: 47x47 cm

Door opening

measurements: 64x131 cm

Roof boards: 16 mm

Roof area: 5,3 m²

Roof gradient: 26,5°

Gross ground area: 2,6 m²

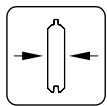

19 mm

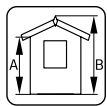

A: 149 cm
B: 194 cm

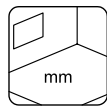

Included
16 mm

OPTIONAL

Roofing felt (underlayer): 1 roll, SBS roofing material: 1 roll, shingles: 3 packs, roofing nails.



Safety
Regular
Production
Surveillance

www.tuv.com
ID 0000085235

PALMAKO KIDS STINA 3,1 m²

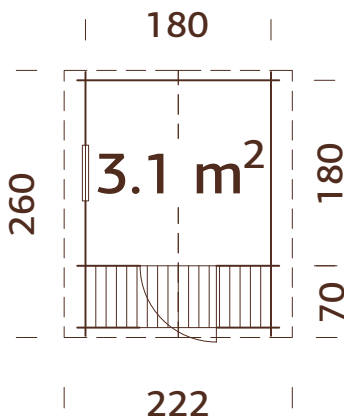

MODEL SPECIFICATIONS

Log measurements:

196x196(256) cm

Volume: 5,2 m³

Door/window glass:

Acrylglass

Fixed window

measurements: 47x47 cm

Door opening

measurements: 64x131 cm

Roof boards: 16 mm

Roof area: 6,2 m²

Roof gradient: 23,5°

Gross ground area: 3,2 m²

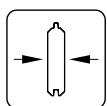

19 mm

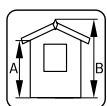

A: 149 cm
B: 193 cm

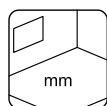

Included
16 mm

OPTIONAL

Roofing felt (underlayer): 1 roll, SBS roofing material: 1 roll, shingles: 3 packs, roofing nails.



Safety
Regular
Production
Surveillance

www.tuv.com
ID 0000083312

PALMAKO KIDS FELIX 1,9 m²

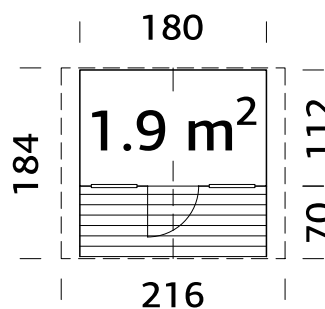

Ready-made wall elements.

MODEL SPECIFICATIONS

Wall measurements:

180x112(180) cm

Volume: 3,0 m³

Window glass: Acrylglass

Fixed window

measurements: 38x44 cm

Door opening

measurements: 51x115 cm

Roof boards: 16 mm

Roof area: 4,6 m²

Roof gradient: 29,0°

Gross ground area: 2,0 m²

TREATMENT OPTIONS

white primer

OPTIONAL

Roofing felt (underlayer): 1 roll,

SBS roofing material: 1 roll, shingles: 2 packs, roofing nails.

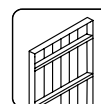

16+28 mm

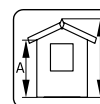

A: 117 cm
B: 169 cm

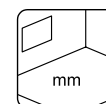

Included
16 mm

PALMAKO KIDS TOBY 2,1 m²

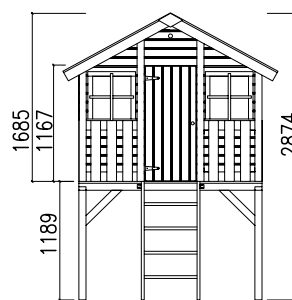
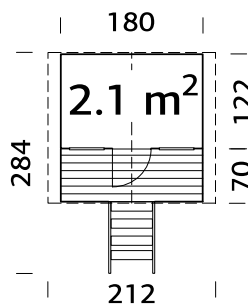

Ready-made wall elements.

MODEL SPECIFICATIONS

Wall measurements:

180x122(190) cm

Volume: 3,0 m³

Window glass:

Acrylglass

Fixed window

measurements: 38x44 cm

Door opening

measurements: 51x115 cm

Roof boards: 16 mm

Roof area: 4,6 m²

Roof gradient: 29,0°

Gross ground area: 2,2 m²

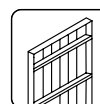

16+28 mm

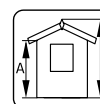

A: 117 cm
B: 169/287 cm

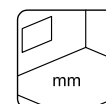

Included
16 mm

OPTIONAL

Anchors x4, roofing felt (underlayer): 1 roll,

SBS roofing material: 1 roll, shingles: 2 packs, roofing nails, slide, swing beam.



PALMAKO TOBY SWING BEAM



On-the-ground product.

ADDITIONAL

Anchors x2.

MODEL SPECIFICATIONS

Length: 241 cm

Width: 208 cm

Safety area: 445x700 cm

Measurements of swing beam: 90x90 mm, glued laminated wood

Measurements of swing legs: 70x70 mm

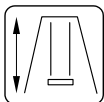

215 cm



3-14 years
max 50 kg

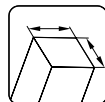

Square wood

OPTIONAL

Anchors x2.



Safety
Regular
Production
Surveillance

www.tuv.com
ID 0000081777

PALMAKO TOBY SET

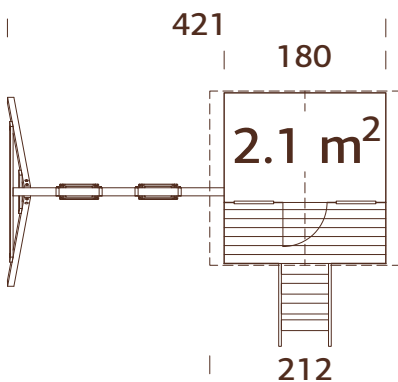

Ready-made wall elements.
NB! Slide is an optional extra!

MODEL SPECIFICATIONS

Wall measurements:

180x122(190) cm

Volume: 3,0 m³

Window glass: Acrylglass

Fixed window

measurements: 38x44 cm

Door opening

measurements: 51x115 cm

Roof boards: 16 mm

Roof area: 4,6 m²

Roof gradient: 29,0°

Gross ground area: 2,2 m²

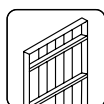

16+28 mm

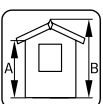

A: 117 cm
B: 169/287 cm

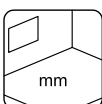

Included
16 mm

OPTIONAL

Anchors x6, roofing felt (underlayer): 1 roll, SBS roofing material: 1 roll, shingles: 2 packs, roofing nails, slide.



Safety
Regular
Production
Surveillance

www.tuv.com
ID 0000081777

PALMAKO KIDS OTTO 3,6 m²

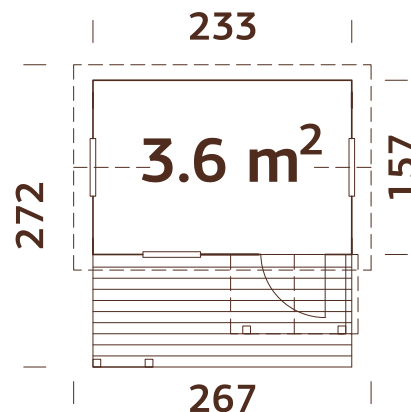

Ready-made wall elements.

TREATMENT OPTIONS

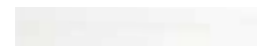

white primer

MODEL SPECIFICATIONS

Wall measurements:

233x157(258) cm

Volume: 6,4 m³

Door/window glass:

Acrylglass

Fixed window

measurements: 56x56 cm

Door opening

measurements: 55x112 cm

Roof boards: 16 mm

Roof area: 7,1 m²

Roof gradient: 40,0°

Gross ground area: 3,7 m²

OPTIONAL

Roofing felt (underlayer): 1 roll, SBS roofing material: 1 roll, shingles: 3 packs, roofing nails.



Safety
Regular
Production
Surveillance

www.tuv.com
ID 0000085235

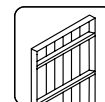

16+32 mm

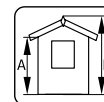

A: 138 cm
B: 219 cm

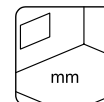

Included
16 mm

PALMAKO KIDS JENNIE 3,6 m²

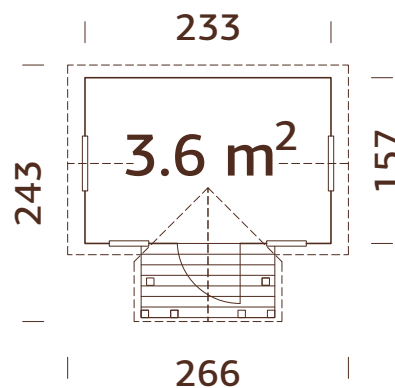

Ready-made wall elements.

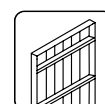

16+32 mm

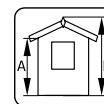

A: 138 cm
B: 219 cm

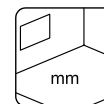

Included
16 mm

MODEL SPECIFICATIONS

Wall measurements:

233x157 cm

Volume: 6,4 m³

Door/window glass:

Acrylglass

Fixed window

measurements: 56x56 cm

Door opening

measurements: 55x131 cm

Roof boards: 16 mm

Roof area: 8,6 m²

Roof gradient: 40,0°

Gross ground area: 3,7 m²

OPTIONAL

Roofing felt (underlayer): 1 roll, SBS roofing material: 1 roll, shingles 3 packs, roofing nails.



Safety
Regular
Production
Surveillance

www.tuv.com
ID 0000081777

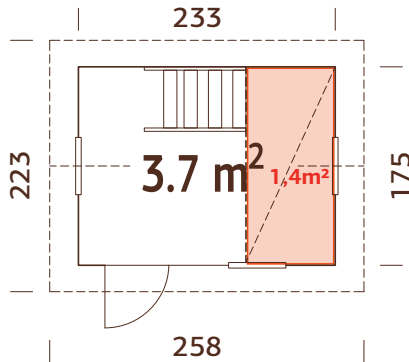
PALMAKO KIDS GRETE 3,7 m²

Ready-made wall elements.

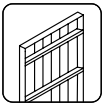

16+32 mm

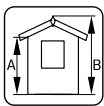
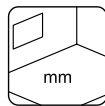
A: 170 cm
B: 220 cmIncluded
16 mm**MODEL SPECIFICATIONS****Wall measurements:**

233x175 cm

Volume: 7,1 m³**Door/window glass:**

Acrylglas

Fixed window**measurements:** 59x59 cm**Door opening****measurements:** 58x130 cm**Roof boards:** 16 mm**Roof area:** 7,1 m²**Roof gradient:** 30,0°**Gross ground area:** 4,1 m²**Ground floor:** 3,7 m²**First floor:** 1,4 m²**OPTIONAL**

Roofing felt (underlayer): 1 roll, SBS roofing material: 1 roll, shingles: 3 packs, roofing nails.

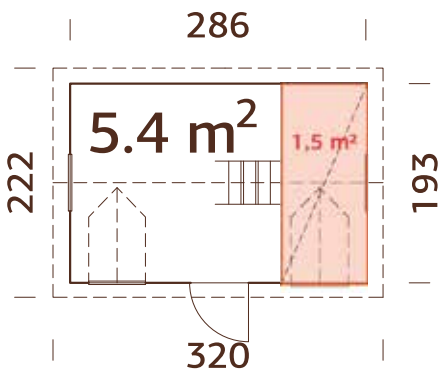
Safety
Regular
Production
Surveillancewww.tuv.com
ID 0000085235PALMAKO KIDS MARIE 5,4 m²

Ready-made wall elements.

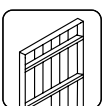

16+32 mm

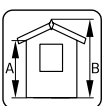
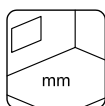
A: 138 cm
B: 234 cmIncluded
16 mm**MODEL SPECIFICATIONS****Wall measurements:**

286x193 cm

Volume: 10,2 m³**Door/window glass:**

Acrylglas

Fixed window**measurements:** 38x54 cm**Door opening****measurements:** 58x112 cm**Roof boards:** 16 mm**Roof area:** 10,0 m²**Roof gradient:** 40,0°**Gross ground area:** 5,5 m²**Ground floor:** 5,4 m²**First floor:** 1,5 m²**OPTIONAL**

Roofing felt (underlayer): 2 rolls, SBS roofing material: 2 rolls, shingles: 5 packs, roofing nails.

Safety
Regular
Production
Surveillancewww.tuv.com
ID 0000085235

PALMAKO KIDS TOM 3,8 m²



Scan this QR-code to see the assembly of Tom 3,8 m²!

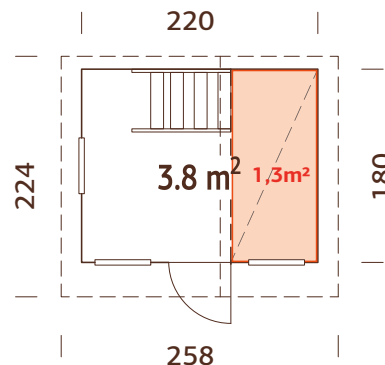

Ready-made wall elements.

MODEL SPECIFICATIONS

Wall measurements:

220x180 cm

Volume: 6.5 m³

Window glass:

Acrylglas

Fixed window

measurements: 35x35 cm

Door opening

measurements: 51x115 cm

Roof boards: 16 mm

Roof area: 7.0 m²

Roof gradient: 37.0°; 31.0°

Gross ground area: 4.0 m²

Ground floor: 3.8 m²

First floor: 1.3 m²

TREATMENT OPTIONS



white primer

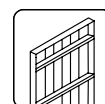

16+32 mm

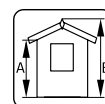

A: 125/177 cm
B: 228 cm

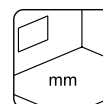

Included
16 mm

OPTIONAL

Roofing felt (underlayer): 1 roll, SBS roofing material: 1 roll, shingles: 3 packs, roofing nails.



Safety
Regular
Production
Surveillance

www.tuv.com
ID 000085235

PALMAKO KIDS HUCK 3,3 m²

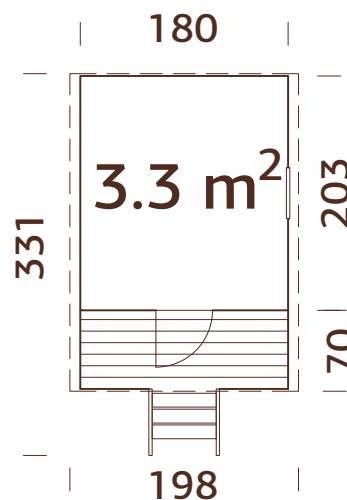

Ready-made wall elements.

MODEL SPECIFICATIONS

Wall measurements:

180x203(271) cm

Volume: 5,2 m³

Door/window glass:

Acrylglas

Fixed window

measurements: 37x43 cm

Door opening

measurements: 51x124 cm

Roof boards: 16 mm

Roof area: 5,6 m²

Gross ground area: 3,7 m²

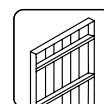

16+28 mm

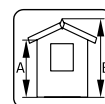

A: 133 cm
B: 225 cm

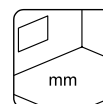

Included
16 mm

OPTIONAL

Anchors x6, roofing felt (underlayer): 1 roll, SBS roofing material: 1 roll, roofing nails.



Safety
Regular
Production
Surveillance

www.tuv.com
ID 000085235

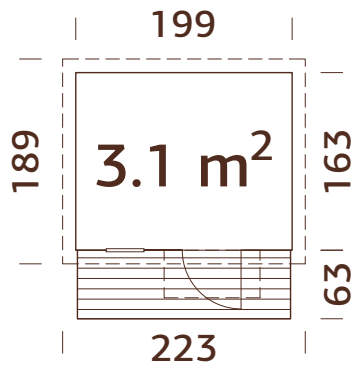
PALMAKO KIDS HARRY 3,1 m²

Ready-made wall elements.

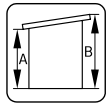
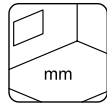

16+32 mm

A: 153 cm
B: 189 cmIncluded
16 mm**MODEL SPECIFICATIONS****Wall measurements:**

199x163(223) cm

Volume: 5,1 m³**Door/window glass:**

Acrylglas

Fixed window**measurements:** 38x116 cm**Door opening****measurements:** 56x141 cm**Roof boards:** 16 mm**Roof area:** 4,2 m²**Roof gradient:** 9,0°**Gross ground area:** 3,2 m²**OPTIONAL**

Roofing felt (underlayer): 1 roll, SBS roofing material: 1 roll, roofing nails.

Safety
Regular
Production
Surveillancewww.tuv.com
ID 0000085235**OPTIONAL PRODUCTS**

SEE OPTIONAL PRODUCTS, PAGES 344-368



House	Art. No.	Roofing felt. rolls	SBS roofing material. rolls	Shingles ¹ . packs	Roofing nails. 1 kg	F-Anchor 50x500 mm	Slide for 120 cm platform 495 x 2300 mm
Sam 2,4 m ²	101761	107210, 1 roll	107214, 1 roll	3 packs	107930		
Stina 3,1 m ²	101766	107210, 1 roll	107214, 1 roll	3 packs	107930		
Felix 1,9 m ²	101125	107210, 1 roll	107214, 1 roll	2 packs	107930		
Toby 2,1 m ²	101129	107210, 1 roll	107214, 1 roll	2 packs	107930	100997, 4 pieces	101004, 107382
Toby Set	109507	107210, 1 roll	107214, 1 roll	2 packs	107930	100997, 6 pieces	101004, 107382
Otto 3,6 m ²	101249	107210, 1 roll	107214, 1 roll	3 packs	107930		
Jennie 3,6 m ²	109459	107210, 1 roll	107214, 1 roll	3 packs	107930		
Grete 3,7 m ²	101245	107210, 1 roll	107214, 1 roll	3 packs	107930		
Marie 5,4 m ²	108997	107210, 2 rolls	107214, 2 rolls	5 packs	107930		
Tom 3,8 m ²	101091	107210, 1 roll	107214, 1 roll	3 packs	107930		
Huck 3,3 m ²	101105	107210, 1 roll	107214, 1 roll		107930	100997, 6 pieces	
Harry 3,1 m ²	101109	107210, 1 roll	107214, 1 roll		107930		

¹ Shingles are available in different colours - 107180 = Black, 107182 = Red, 107183 = Green, 107181 = Brown.



Amanda 11,2+7,8 m² Slide Plus



CABINS

Gable roof

GABLE ROOF CABINS



PALMAKO CABIN
VIVIAN 3,8 m²



PALMAKO CABIN
VIVIAN 6,9 m²



PALMAKO CABIN
LOTTA 7,3 m²



PALMAKO CABIN
LOTTA 10,0 m²



PALMAKO CABIN
LOTTA 13,9 m²



PALMAKO CABIN
KLARA 4,7 m²



PALMAKO CABIN
KLARA 10,4 m²



PALMAKO CABIN
KLARA 17,0 m²



PALMAKO CABIN
VALENTINE 4,7 m²



PALMAKO CABIN
VALENTINE 6,1 m²



PALMAKO CABIN
VALENTINE 9,0 m²



PALMAKO CABIN
VALENTINE 11,0 m²



PALMAKO CABIN
BRITTA 14,6 m²



PALMAKO CABIN
BRITTA 17,5 m²



PALMAKO CABIN
BRITTA 19,7 m²



PALMAKO CABIN
BRITTA 22,3 m²



PALMAKO CABIN
EMMA 4,6 m²



PALMAKO CABIN
EMMA 10,4 m²



PALMAKO CABIN
EMMA 10,4+4,2 m²



PALMAKO CABIN
EMMA 14,2 m²



PALMAKO CABIN
SALLY 10,2 m²



PALMAKO CABIN
SALLY 12,3 m²



PALMAKO CABIN
SALLY 15,5 m²



PALMAKO CABIN
SALLY 19,1 m²



PALMAKO CABIN
HELENA 15,1 m²



PALMAKO CABIN
HELENA 18,6 m²



PALMAKO CABIN
HELENA 24,6 m²

PALMAKO GABLE
ROOF CABINS
40-77



PALMAKO CABIN
SUSANNA 12,4 m²



PALMAKO CABIN
SUSANNA 16,4 m²



PALMAKO CABIN
IRENE 19,0 m²



PALMAKO CABIN
IRENE 23,9 m²



PALMAKO CABIN
IRENE 21,9+5,2 m²



PALMAKO CABIN
IRENE 27,7 m²



PALMAKO CABIN
IRENE 19,0+16,2 m²

NEW



PALMAKO CABIN
IRENE 19,0+33,2 m²

NEW



PALMAKO CABIN
IRIS 9,6 m²



PALMAKO CABIN
IRIS 11,1 m²



PALMAKO CABIN
IRIS 19,1 m²



PALMAKO CABIN
CLAUDIA 14,2 m²

NEW



PALMAKO CABIN
CLAUDIA 11,5 m²



PALMAKO CABIN
CLAUDIA 19,4 m²



PALMAKO CABIN
CLAUDIA PENT 11,5 m²

NEW



PALMAKO CABIN
CLAUDIA PENT 19,4 m²

NEW



PALMAKO CABIN
INES 11,1 m²



PALMAKO CABIN
INES 13,7 m²



PALMAKO CABIN
INES 11,1 m²
SLIDE / SLIDE PLUS



PALMAKO CABIN
INES 13,7 m²
SLIDE / SLIDE PLUS



PALMAKO CABIN
AMANDA 11,2 m²
SLIDE / SLIDE PLUS

NEW



PALMAKO CABIN
AMANDA 11,2+7,8 m²
SLIDE / SLIDE PLUS

NEW



PALMAKO CABIN
AMANDA 17,1 m²
SLIDE / SLIDE PLUS

NEW



PALMAKO CABIN
AMANDA 17,1+7,8 m²
SLIDE / SLIDE PLUS

NEW

PALMAKO CABIN VIVIAN 3,8 m²

under
2,5m

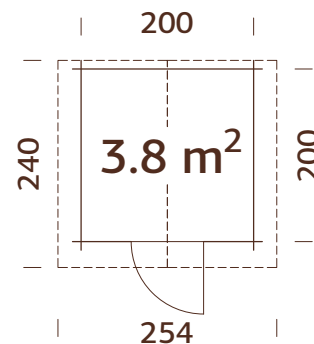

MODEL SPECIFICATIONS

Log measurements:

220x220 cm

Volume: 8,1 m³

Door/window type: Garden

Door/window glass:

Real glass, 4 mm

Door opening

measurements: 73x175 cm

Door sill: low, covered with stainless steel

Roof boards: 19 mm

Roof area: 6,2 m²

Roof gradient: 16,3°

Gross ground area: 4,0 m²

TREATMENT

Available dipped

Available painted

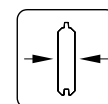

28 mm

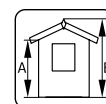

A: 190 cm
B: 222 cm

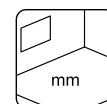

Included
19 mm

OPTIONAL

Roofing felt (underlayer): 1 roll, SBS roofing material: 1 roll, shingles: 3 packs, roofing nails, rain gutters, additional door.

PALMAKO CABIN VIVIAN 6,9 m²

under
2,5m

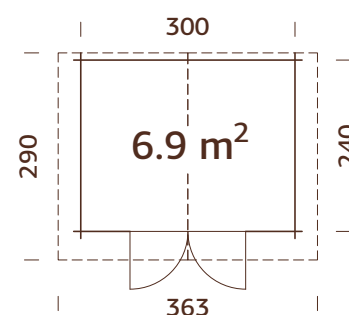

MODEL SPECIFICATIONS

Log measurements:

320x260 cm

Volume: 16,1 m³

Door/window type: Garden

Door/window glass:

Real glass, 4 mm

Door opening

measurements: 151x175 cm

Door sill: low, covered with stainless steel

Roof boards: 19 mm

Roof area: 11,0 m²

Roof gradient: 19,2°

Gross ground area: 7,2 m²

TREATMENT

Available dipped

Available painted

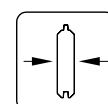

28 mm

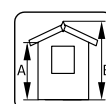

A: 194 cm
B: 245 cm

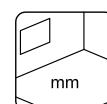

Included
19 mm

OPTIONAL

Roofing felt (underlayer): 2 rolls, SBS roofing material: 2 rolls, shingles: 5 packs, roofing nails, rain gutters, additional door.

PALMAKO CABIN LOTTA 7,3 m²

under
2,5m

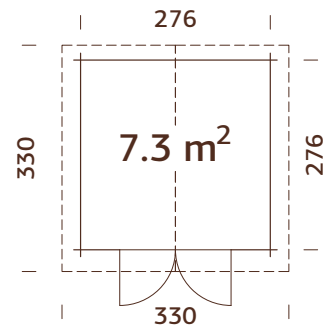

TREATMENT

- Available dipped
- Available painted

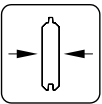

28 mm

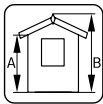

A: 194 cm
B: 247 cm

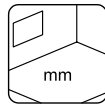

NB! Floor is an optional extra! 19 mm

MODEL SPECIFICATIONS

Log measurements:

296x296 cm

Volume: 16,1 m³

Door/window type: Garden

Door/window glass:

Real glass, 4 mm

Door opening

measurements: 151x175 cm

Door sill: low,

covered with stainless steel

Roof boards: 16 mm

Roof area: 11,5 m²

Roof gradient: 20,6°

Gross ground area: 7,6 m²

OPTIONAL

Floor, roofing felt (underlayer): 3 rolls, SBS roofing material: 3 rolls, shingles: 5 packs, roofing nails, rain gutters, extension, canopy roof, additional door.

PALMAKO GABLE ROOF CABINS 40-77

PALMAKO CABIN LOTTA 10,0 m²

under
2,5m

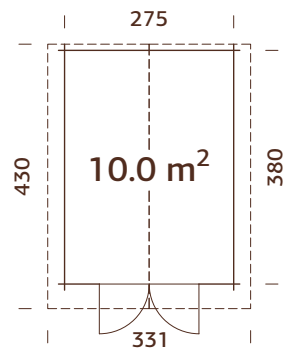

TREATMENT

- Available dipped
- Available painted

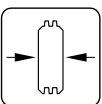

34 mm

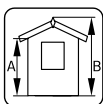

A: 194 cm
B: 247 cm

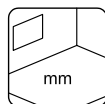

NB! Floor is an optional extra! 19 mm

MODEL SPECIFICATIONS

Log measurements:

295x400 cm

Volume: 22,0 m³

Door/window type:

Garden

Door/window glass:

Real glass, 4 mm

Door opening

measurements: 151x175 cm

Door sill: wooden

Roof boards: 16 mm

Roof area: 15,1 m²

Roof gradient: 20,7°

Gross ground area: 10,5 m²

OPTIONAL

Floor, roofing felt (underlayer): 3 rolls, SBS roofing material: 3 rolls, shingles: 6 packs, roofing nails, rain gutters, canopy roof, additional door.

PALMAKO CABIN LOTTA 13,9 m²

under
2,5m

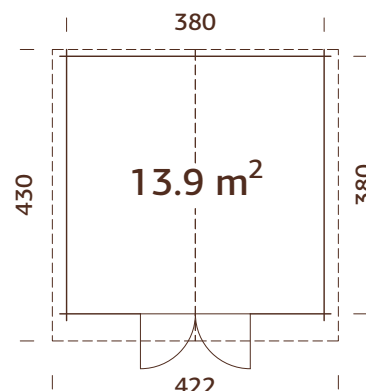

MODEL SPECIFICATIONS

Log measurements:

400x400 cm

Volume: 29,8 m³

Door/window type:

Garden

Door/window glass:

Real glass, 4 mm

Door opening

measurements: 151x175 cm

Door sill: wooden

Roof boards: 16 mm

Roof area: 19,1 m²

Roof gradient: 18,6°

Gross ground area: 14,4 m²

TREATMENT

Available dipped

Available painted

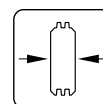

34 mm

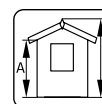

A: 182 cm
B: 245 cm

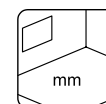

NB! Floor is an optional extra! 19 mm

OPTIONAL

Floor, roofing felt (underlayer): 3 rolls, SBS roofing material: 3 rolls, shingles: 8 packs, roofing nails, rain gutters, canopy roof, additional door.

PALMAKO CABIN KLARA 4,7 m²

under
2,5m

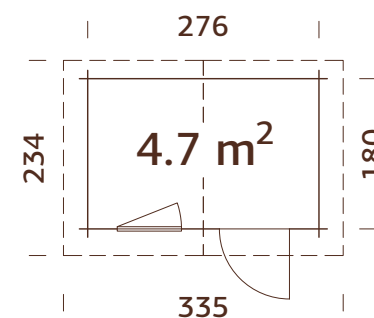

MODEL SPECIFICATIONS

Log measurements:

296x200 cm

Volume: 10,1 m³

Door/window type: Garden

Door/window glass:

Real glass, 4 mm

Window opening

measurements: 66x89 cm

Door opening

measurements: 73x175 cm

Door sill: low,

covered with stainless steel

Roof boards: 16 mm

Roof area: 8,0 m²

Roof gradient: 16,2°

Gross ground area: 5,0 m²

TREATMENT

Available dipped

Available painted

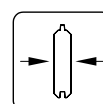

28 mm

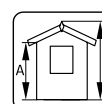

A: 194 cm
B: 235 cm

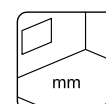

NB! Floor is an optional extra! 19 mm

OPTIONAL

Floor, roofing felt (underlayer): 2 rolls, SBS roofing material: 2 rolls, shingles: 4 packs, roofing nails, rain gutters, additional door and window.

PALMAKO CABIN KLARA 10,4 m²

under
2,5m

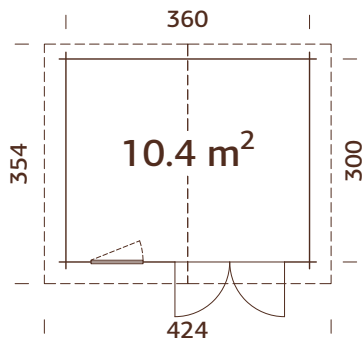

TREATMENT

- Available dipped
Available painted

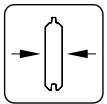

28 mm

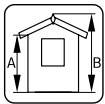

A: 194 cm
B: 247 cm

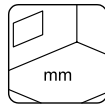

NB! Floor is an optional extra! 19 mm

MODEL SPECIFICATIONS

Log measurements:

380x320 cm

Volume: 22,9 m³

Door/window type: Garden

Door/window glass:

Real glass, 4 mm

Window opening

measurements: 66x89 cm

Door opening

measurements: 139x175 cm

Door sill: low,

covered with stainless steel

Roof boards: 16 mm

Roof area: 15,4 m²

Roof gradient: 16,1°

Gross ground area: 10,8 m²

OPTIONAL

Floor, roofing felt (underlayer): 3 rolls, SBS roofing material: 3 rolls, shingles: 6 packs, roofing nails, rain gutters, extension, canopy roof, additional door and window.

PALMAKO CABIN KLARA 17,0 m²



under
2,5m

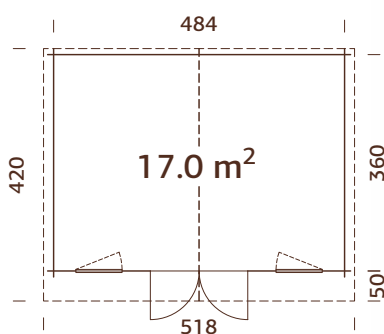

TREATMENT

- Available dipped
Available painted

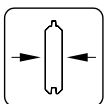

28 mm

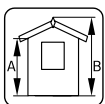

A: 182 cm
B: 245 cm

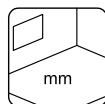

NB! Floor is an optional extra! 19 mm

MODEL SPECIFICATIONS

Log measurements:

504x380 cm

Volume: 36,3 m³

Door/window type: Garden

Door/window glass:

Real glass, 4 mm

Window opening

measurements: 66x89 cm

Door opening

measurements: 139x175 cm

Door sill: low, covered with

stainless steel

Roof boards: 16 mm

Roof area: 22,4 m²

Roof gradient: 14,6°

Gross ground area: 17,4 m²

OPTIONAL

Floor, roofing felt (underlayer): 4 rolls, SBS roofing material: 4 rolls, shingles: 10 packs, roofing nails, rain gutters, canopy roof, additional door and window.

PALMAKO CABIN VALENTINE 4,7 m²



under 2,5m

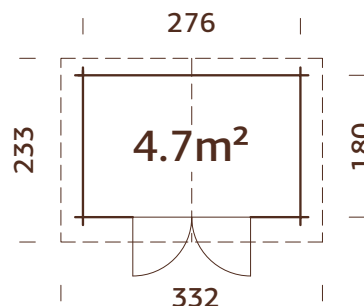

MODEL SPECIFICATIONS

Log measurements:

296x200 cm

Volume: 10,1 m³

Door/window type: Garden

Door/window glass:

Real glass, 4 mm

Door opening

measurements: 139x175 cm

Door sill: low, covered with stainless steel

Roof boards: 16 mm

Roof area: 7.9 m²

Roof gradient: 16,2°

Gross ground area: 5.0 m²

TREATMENT



brown pressure-treated

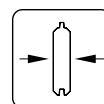

28 mm

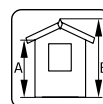

A: 194 cm

B: 236 cm

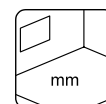

NB! Floor is an optional extra! 19 mm

OPTIONAL

Floor, roofing felt (underlayer): 2 rolls, SBS roofing material: 2 rolls, shingles 4 packs, roofing nails, rain gutters, canopy roof, additional door and window.

PALMAKO CABIN VALENTINE 6,1 m²



under 2,5m

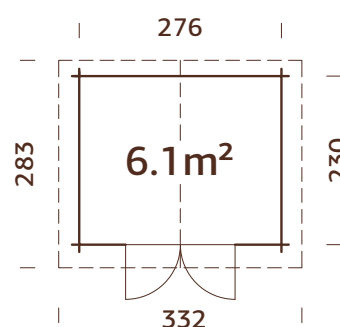

MODEL SPECIFICATIONS

Log measurements:

296x250 cm

Volume: 13.0 m³

Door/window type: Garden

Door/window glass:

Real glass, 4 mm

Door opening

measurements: 139x175 cm

Door sill: low, covered with stainless steel

Roof boards: 16 mm

Roof area: 9.6 m²

Roof gradient: 16,2°

Gross ground area: 6.3 m²

TREATMENT



brown pressure-treated

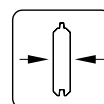

28 mm

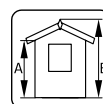

A: 194 cm

B: 235 cm

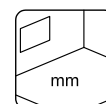

NB! Floor is an optional extra! 19 mm

OPTIONAL

Floor, roofing felt (underlayer): 2 rolls, SBS roofing material: 2 rolls, shingles 4 packs, roofing nails, rain gutters, extension, canopy roof, additional door and window.

PALMAKO CABIN VALENTINE 9,0 m²



under
2,5m

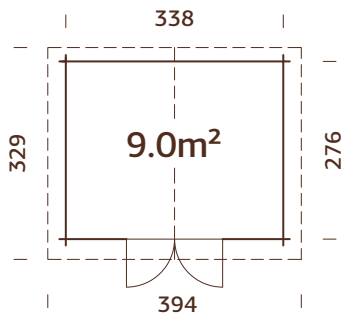

TREATMENT



brown pressure-treated

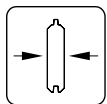

28 mm

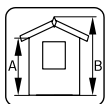

A: 194 cm
B: 235 cm

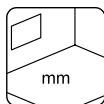

NB! Floor is an optional extra! 19 mm

MODEL SPECIFICATIONS

Log measurements:

358x296 cm

Volume: 18.1 m³

Door/window type: Garden

Door/window glass:

Real glass, 4 mm

Door opening

measurements: 139x175 cm

Door sill: low, covered with stainless steel

Roof boards: 16 mm

Roof area: 12,5 m²

Roof gradient: 13,3°

Gross ground area: 9,3 m²

OPTIONAL

Floor, roofing felt (underlayer): 3 rolls, SBS roofing material: 3 rolls, shingles 6 packs, roofing nails, rain gutters, extension, canopy roof, additional door and window.

PALMAKO GABLE ROOF CABINS

40-77

PALMAKO CABIN VALENTINE 11,0 m²

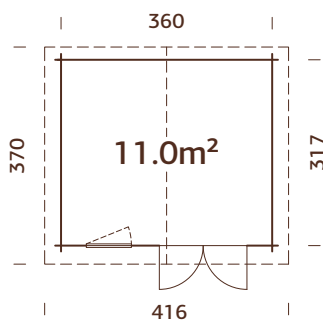

TREATMENT



brown pressure-treated

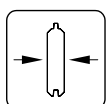

28 mm

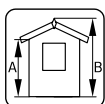

A: 205 cm
B: 258 cm

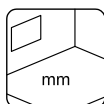

NB! Floor is an optional extra! 19 mm

MODEL SPECIFICATIONS

Log measurements:

380x337 cm

Volume: 25,5 m³

Door/window type: Garden

Door/window glass:

Real glass, 4 mm

Window opening

measurements: 66x89 cm

Door opening measurements: 139x175 cm

Door sill: low, covered with stainless steel

Roof boards: 16 mm

Roof area: 15,8 m²

Roof gradient: 16,0°

Gross ground area: 11,4 m²

OPTIONAL

Floor, roofing felt (underlayer): 3 rolls, SBS roofing material: 3 rolls, shingles 7 packs, roofing nails, rain gutters, extension, canopy roof, additional door and window.

PALMAKO CABIN BRITTA 14,6 m²

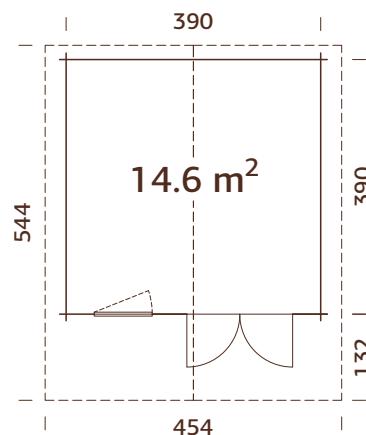

MODEL SPECIFICATIONS

Log measurements:

410x410 cm

Volume: 33,7 m³

Door/window type: Garden

Door/window glass:

Real glass, 4 mm

Window opening

measurements: 78x89 cm

Door opening

measurements: 151x186 cm

Door sill: low, covered with

stainless steel

Roof boards: 19 mm

Roof area: 25,2 m²

Roof gradient: 15,0°

Gross ground area: 15,2 m²

TREATMENT

Available dipped

Available painted

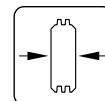

40 mm

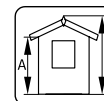

A: 205 cm
B: 257 cm

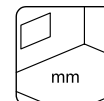

NB! Floor is an optional extra! 19 mm

OPTIONAL

Floor, roofing felt (underlayer): 7 rolls, SBS roofing material: 7 rolls, shingles: 10 packs, roofing nails, rain gutters, extension, canopy roof, additional door and window.

PALMAKO CABIN BRITTA 17,5 m²

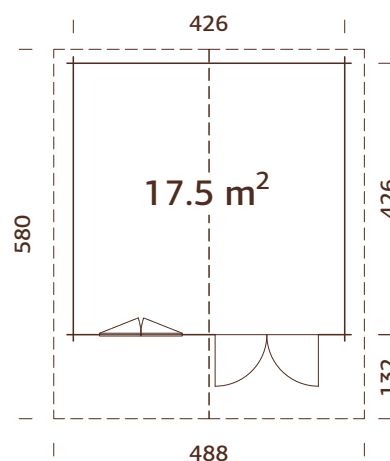

MODEL SPECIFICATIONS

Log measurements:

446x446 cm

Volume: 41,4 m³

Door/window type: Garden

Door/window glass:

Real glass, 4 mm

Window opening

measurements: 119x89 cm

Door opening

measurements: 151x186 cm

Door sill: low,

covered with stainless steel

Roof boards: 19 mm

Roof area: 29,3 m²

Roof gradient: 16,5°

Gross ground area: 18,1 m²

TREATMENT

Available dipped

Available painted

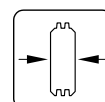

40 mm

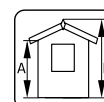

A: 205 cm
B: 270 cm

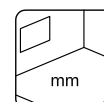

NB! Floor is an optional extra! 19 mm

OPTIONAL

Floor, roofing felt (underlayer): 7 rolls, SBS roofing material: 7 rolls, shingles: 11 packs, roofing nails, rain gutters, extension, canopy roof, additional door and window.



PALMAKO CABIN BRITTA 19,7 m²

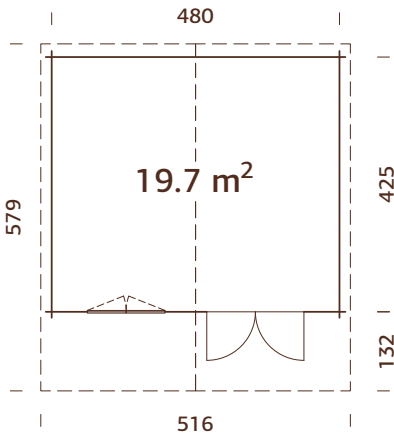

TREATMENT

- Available dipped
- Available painted

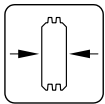

40 mm

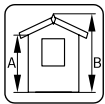

A: 205 cm
B: 270 cm

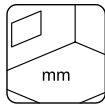

NB! Floor is an optional extra! 19 mm

MODEL SPECIFICATIONS

Log measurements:

500x445 cm

Volume: 46,6 m³

Door/window type: Garden

Door/window glass:

Real glass, 4 mm

Window opening

measurements: 119x89 cm

Door opening

measurements: 151x186 cm

Door sill: low,

covered with stainless steel

Roof boards: 19 mm

Roof area: 30,7 m²

Roof gradient: 14,7°

Gross ground area: 20,4 m²

OPTIONAL

Floor, roofing felt (underlayer): 7 rolls, SBS roofing material: 7 rolls, shingles: 12 packs, roofing nails, rain gutters, extension, canopy roof, additional door and window.

PALMAKO GABLE ROOF CABINS 40-77

PALMAKO CABIN BRITTA 22,3 m²

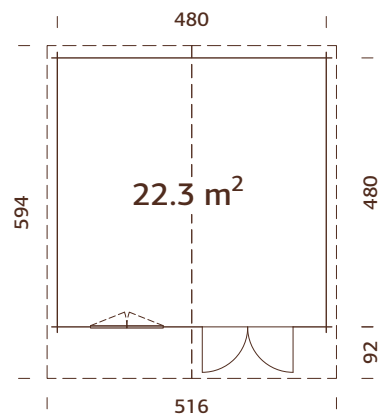

Strong purlins from laminated wood.

TREATMENT

- Available dipped
- Available painted

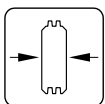

40 mm

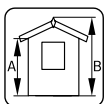

A: 205 cm
B: 270 cm

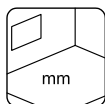

NB! Floor is an optional extra! 19 mm

MODEL SPECIFICATIONS

Log measurements:

500x500 cm

Volume: 52,7 m³

Door/window type: Garden

Door/window glass:

Real glass, 4 mm

Window opening

measurements: 119x89 cm

Door opening

measurements: 151x186 cm

Door sill: low, covered with

stainless steel

Roof boards: 19 mm

Roof area: 29,2 m²

Roof gradient: 14,7°

Gross ground area: 23,0 m²

OPTIONAL

Floor, roofing felt (underlayer): 7 rolls, SBS roofing material: 7 rolls, shingles: 12 packs, roofing nails, rain gutters, extension, canopy roof, additional door and window.

PALMAKO CABIN EMMA 4,6 m²

under
2,5m

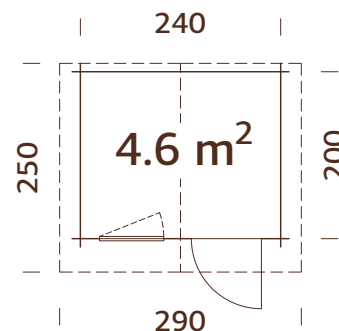

MODEL SPECIFICATIONS

Log measurements:

260x220 cm

Volume: 10,2 m³

Door/window type: Garden

Door/window glass:

Real glass, 4 mm

Window opening

measurements: 66x89 cm

Door opening

measurements: 73x175 cm

Door sill: low, covered with stainless steel

Roof boards: 19 mm

Roof area: 7,4 m²

Roof gradient: 13,7°

Gross ground area: 4,8 m²

TREATMENT

Available dipped

Available painted

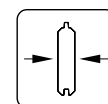

28 mm

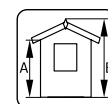

A: 194 cm
B: 222 cm

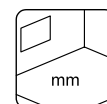

Included
19 mm

OPTIONAL

Roofing felt (underlayer): 2 rolls, SBS roofing material: 2 rolls, shingles: 4 packs, roofing nails, rain gutters, additional door and window.

PALMAKO CABIN EMMA 10,4 m²

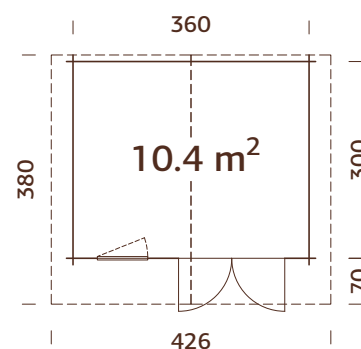

MODEL SPECIFICATIONS

Log measurements:

380x320 cm

Volume: 23,9 m³

Door/window type: Garden

Door/window glass:

Real glass, 4 mm

Window opening

measurements: 66x89 cm

Door opening

measurements: 151x175 cm

Door sill: low, covered with stainless steel

Roof boards: 19 mm

Roof area: 16,8 m²

Roof gradient: 16,2°

Gross ground area: 10,8 m²

TREATMENT

Available dipped

Available painted

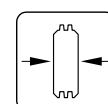

34 mm

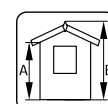

A: 205 cm
B: 257 cm

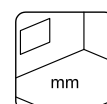

Included
19 mm

OPTIONAL

Roofing felt (underlayer): 3 rolls, SBS roofing material: 3 rolls, shingles: 7 packs, roofing nails, rain gutters, extension, canopy roof, additional door and window.

PALMAKO CABIN EMMA 10,4+4,2 m²

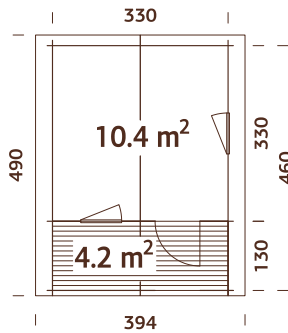

Terrace boards are treated.
NBI Shutters and terrace included!

TREATMENT

Available dipped

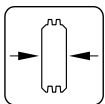

34 mm

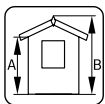

A: 205 cm
B: 257 cm

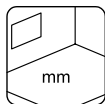

Included
19 mm

MODEL SPECIFICATIONS

Log measurements:

350x350(480) cm

Volume: 24,1 m³

Terrace: 330x130 cm

Door/window type: Garden

Door/window glass:

Real glass, 4 mm

Window opening

measurements: 66x89 cm

Door opening

measurements: 73x175 cm

Door sill: low, covered with

stainless steel

Roof boards: 19 mm

Roof area: 20,0 m²

Roof gradient: 17,6°

Gross ground area

(terrace included): 15,2 m²

OPTIONAL

Roofing felt (underlayer): 5 rolls, SBS roofing material: 5 rolls, shingles: 8 packs, roofing nails, rain gutters, extension, canopy roof, additional door and window.

PALMAKO CABIN EMMA 14,2 m²

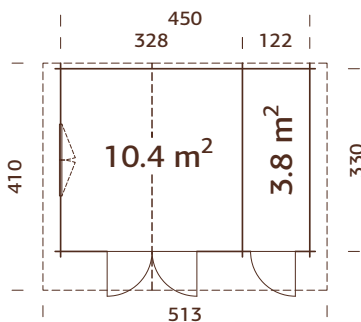

Can be built in reverse!



TREATMENT

Available dipped

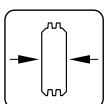

34 mm

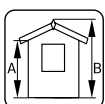

A: 205 cm
B: 268 cm

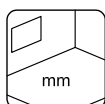

Included
19 mm

MODEL SPECIFICATIONS

Log measurements:

470x350 cm

Volume: 33,0 m³

Door/window type: Garden

Door/window glass:

Real glass, 4 mm

Window opening

measurements: 119x89 cm

Door opening

measurements: 73x164 cm,

151x175 cm

Door sill: low, covered with
stainless steel

Roof boards: 19 mm

Roof area: 22,3 m²

Roof gradient: 21,2°; 14,7°

Gross ground area: 14,9 m²

OPTIONAL

Roofing felt (underlayer): 4 rolls, SBS roofing material: 4 rolls, shingles: 9 packs, roofing nails, rain gutters, additional door and window.

PALMAKO CABIN SALLY 10,2 m²

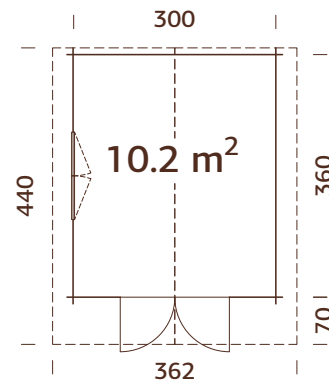

Double glazed.

MODEL SPECIFICATIONS

Log measurements:

320x380 cm

Volume: 23,5 m³

Door/window type: Garden+

Door/window glass:

Double glass, 3-6-3 mm

Window opening

measurements: 119x89 cm

Door opening

measurements: 151x186 cm

Door sill: low, covered with stainless steel

Roof boards: 19 mm

Roof area: 16,7 m²

Roof gradient: 19,2°

Gross ground area: 10,8 m²

TREATMENT

Available dipped

Available painted

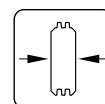

44 mm

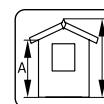

A: 205 cm
B: 263 cm

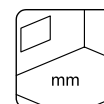

Included
19 mm

OPTIONAL

Roofing felt (underlayer): 3 rolls, SBS roofing material: 3 rolls, shingles: 7 packs, roofing nails, rain gutters, extension, canopy roof, additional door and window.

PALMAKO CABIN SALLY 12,3 m²

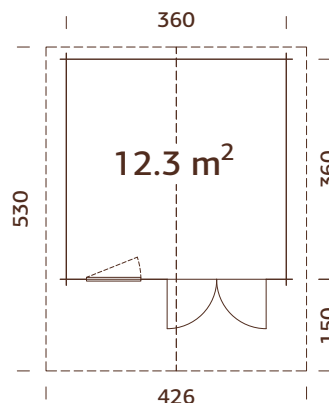

Double glazed.

MODEL SPECIFICATIONS

Log measurements:

380x380 cm

Volume: 28,5 m³

Door/window type: Garden+

Door/window glass:

Double glass, 3-6-3 mm

Window opening

measurements: 78x89 cm

Door opening

measurements: 151x186 cm

Door sill: low, covered with stainless steel

Roof boards: 19 mm

Roof area: 23,3 m²

Roof gradient: 16,1°

Gross ground area: 13,0 m²

TREATMENT

Available dipped

Available painted

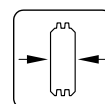

44 mm

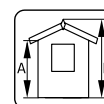

A: 205 cm
B: 256 cm

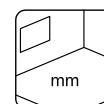

Included
19 mm

OPTIONAL

Roofing felt (underlayer): 6 rolls, SBS roofing material: 6 rolls, shingles: 9 packs, roofing nails, rain gutters, extension, canopy roof, additional door and window.

PALMAKO CABIN SALLY 15,5 m²

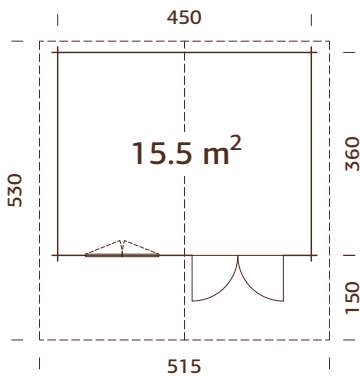

Double glazed.

TREATMENT

- Available dipped
- Available painted

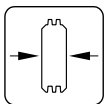

44 mm

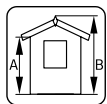

A: 205 cm
B: 268 cm

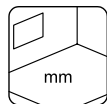

Included
19 mm



Scan this QR-code to see the assembly of Sally 15,5 m²!

MODEL SPECIFICATIONS

Log measurements:

470x380 cm

Volume: 36,6 m³

Door/window type: Garden+

Door/window glass:

Double glass, 3-6-3 mm

Window opening

measurements: 119x89 cm

Door opening

measurements: 151x186 cm

Door sill: low, covered with

stainless steel

Roof boards: 19 mm

Roof area: 28,1 m²

Roof gradient: 15,9°

Gross ground area: 16,2 m²

OPTIONAL

Roofing felt (underlayer): 7 rolls, SBS roofing material: 7 rolls, shingles: 11 packs, roofing nails, rain gutters, extension, canopy roof, additional door and window.

PALMAKO CABIN SALLY 19,1 m²

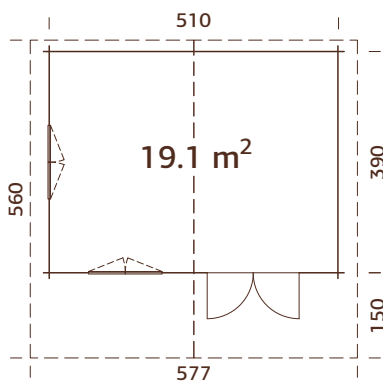

Double glazed.

TREATMENT

- Available dipped
- Available painted

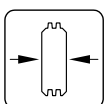

44 mm

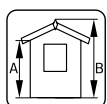

A: 205 cm
B: 278 cm

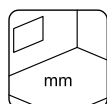

Included
19 mm



MODEL SPECIFICATIONS

Log measurements:

530x410 cm

Volume: 44,9 m³

Door/window type: Garden+

Door/window glass:

Double glass, 3-6-3 mm

Window opening

measurements: 119x89 cm

Door opening

measurements: 151x186 cm

Door sill: low, covered with

stainless steel

Roof boards: 19 mm

Roof area: 35,3 m²

Roof gradient: 14,0°

Gross ground area: 19,9 m²

OPTIONAL

Roofing felt (underlayer): 8 rolls, SBS roofing material: 8 rolls, shingles: 13 packs, roofing nails, rain gutters, extension, canopy roof, additional door and window.

PALMAKO CABIN HELENA 15,1 m²

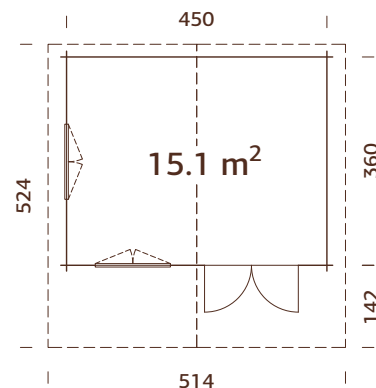

Double glazed.

MODEL SPECIFICATIONS

Log measurements:

470x380 cm

Volume: 37,2 m³

Door/window type: Summer

Door/window glass:

Double glass, 3-9-3 mm

Window opening

measurements: 112x88 cm

Door opening

measurements: 144x179 cm

Door sill: low, covered with

stainless steel

Roof boards: 19 mm

Roof area: 27,6 m²

Roof gradient: 15,4°

Gross ground area: 16,2 m²

TREATMENT

Available dipped

Available painted

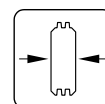

70 mm

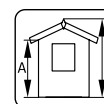

A: 216 cm
B: 285 cm

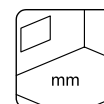

Included
19 mm

OPTIONAL

Roofing felt (underlayer): 7 rolls, SBS roofing material: 7 rolls, shingles: 11 packs, roofing nails, rain gutters, extension, canopy roof, additional door and window.

PALMAKO CABIN HELENA 18,6 m²

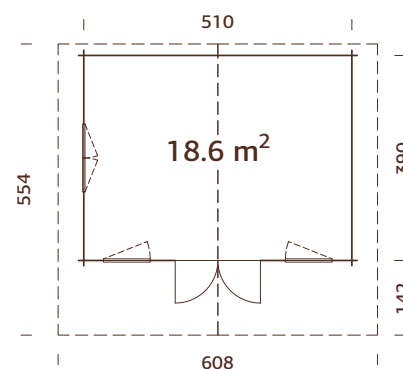

Double glazed.

MODEL SPECIFICATIONS

Log measurements:

530x410 cm

Volume: 47,3 m³

Door/window type: Summer

Door/window glass:

Double glass, 3-9-3 mm

Window opening

measurements: 71x88 cm,

112x88 cm

Door opening

measurements:

144x179 cm

Door sill: low, covered with stainless steel

Roof boards: 19 mm

Roof area: 34,7 m²

Roof gradient: 16,6°

Gross ground area: 19,9 m²

TREATMENT

Available dipped

Available painted

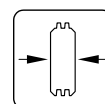

70 mm

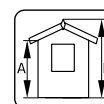

A: 216 cm
B: 290 cm

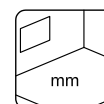

Included
19 mm

OPTIONAL

Roofing felt (underlayer): 8 rolls, SBS roofing material: 8 rolls, shingles: 13 packs, roofing nails, rain gutters, extension, canopy roof, additional door and window.

PALMAKO CABIN HELENA 24,6 m²

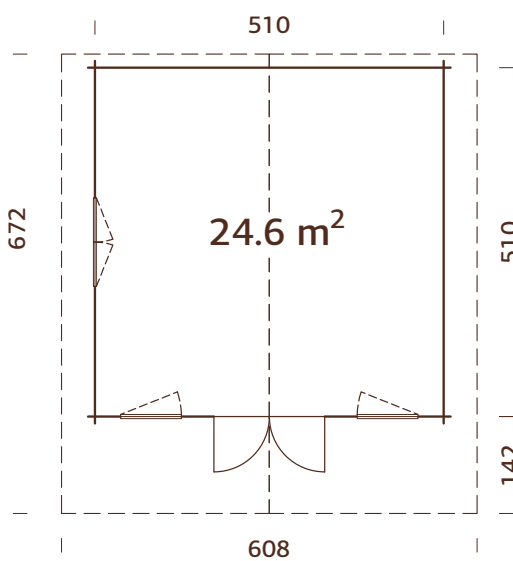

MODEL SPECIFICATIONS

Log measurements: 530x530 cm

Volume: 62,2 m³

Door/window type: Summer

Door/window glass:
Double glass, 3-9-3 mm

Window opening

measurements:
71x88 cm, 112x88 cm

Door opening measurements:

144x179 cm

Door sill: low, covered with
stainless steel

Roof boards: 19 mm

Roof area: 42,2 m²

Roof gradient: 16,7°

Gross ground area: 26,0 m²

OPTIONAL

Roofing felt (underlayer): 8 rolls, SBS roofing material: 8 rolls, shingles: 16 packs, roofing nails, rain gutters, extension, canopy roof, additional door and window.

TREATMENT

Available painted

Double glazed.

Strong purlins from laminated wood.

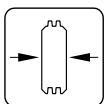

70 mm

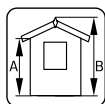

A: 216 cm
B: 290 cm

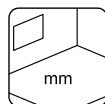

Included
19 mm

PALMAKO CABIN SUSANNA 12,4 m²

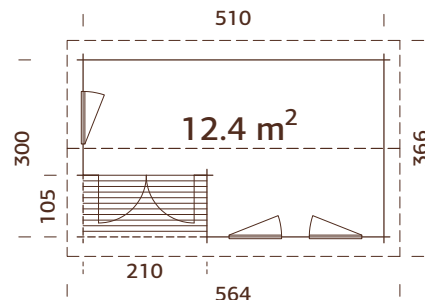

Double glazed.
Can be built in reverse!
Terrace boards are treated.



MODEL SPECIFICATIONS

Log measurements:

530x320 cm

Volume: 28,6 m³

Terrace: 210x105 cm

Door/window type:
Garden+

Door/window glass:

Double glass, 3-6-3 mm

Window opening

measurements: 78x89 cm

Door opening

measurements: 151x186 cm

Door sill: low, covered with stainless steel

Roof boards: 19 mm

Roof area: 21,4 m²

Roof gradient: 18,4°

Gross ground area
(terrace included): 15,3 m²

TREATMENT

Available dipped

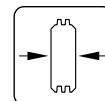

44 mm

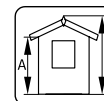

A: 205 cm
B: 263 cm

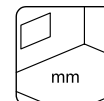

Included
19 mm

OPTIONAL

Roofing felt (underlayer): 5 rolls, SBS roofing material: 5 rolls, shingles: 9 packs, roofing nails, rain gutters, additional door and window.

PALMAKO CABIN SUSANNA 16,4 m²

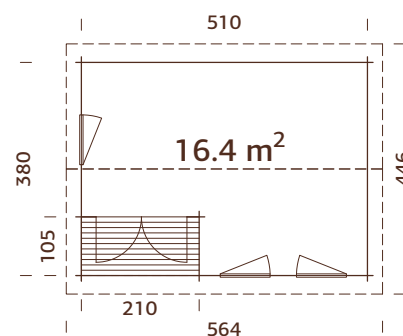

Double glazed.
Can be built in reverse!
Terrace boards are treated.



MODEL SPECIFICATIONS

Log measurements:

530x400 cm

Volume: 37,2 m³

Terrace: 210x105 cm

Door/window type:
Garden+

Door/window glass:

Double glass, 3-6-3 mm

Window opening

measurements: 78x89 cm

Door opening

measurements: 151x186 cm

Door sill: low, covered with stainless steel

Roof boards: 19 mm

Roof area: 26,1 m²

Roof gradient: 18,5°

Gross ground area
(terrace included): 19,4 m²

TREATMENT

Available dipped

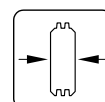

44 mm

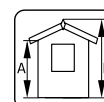

A: 205 cm
B: 278 cm

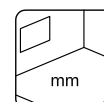

Included
19 mm

OPTIONAL

Roofing felt (underlayer): 6 rolls, SBS roofing material: 6 rolls, shingles: 10 packs, roofing nails, rain gutters, additional door and window.



PALMAKO CABIN IRENE 19,0 m²

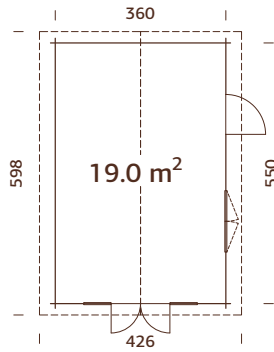

Double glazed.
Strong purlins from laminated wood.



TREATMENT

- Available dipped
- Available painted

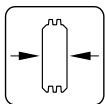

44 mm

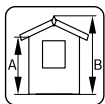

A: 217 cm
B: 276 cm

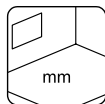

Included
19 mm

MODEL SPECIFICATIONS

Log measurements:

380x570 cm

Volume: 45,9 m³

Door/window type: Garden+

Window glass:

Double glass, 3-6-3 mm

Door glass: Double

toughened glass, 4-6-4 mm

Window opening

measurements: 119x89 cm

Door opening

measurements: 73x175 cm,
114x186 cm

Door sill: low, covered with

stainless steel

Roof boards: 19 mm

Roof area: 26,3 m²

Roof gradient: 16,3°

Gross ground area: 19,8 m²

OPTIONAL

Roofing felt (underlayer): 6 rolls, SBS roofing material: 6 rolls, shingles: 10 packs, roofing nails, rain gutters, extension, canopy roof, additional door and window.

PALMAKO GABLE
ROOF CABINS

40-77

PALMAKO CABIN IRENE 21,9+5,2 m²

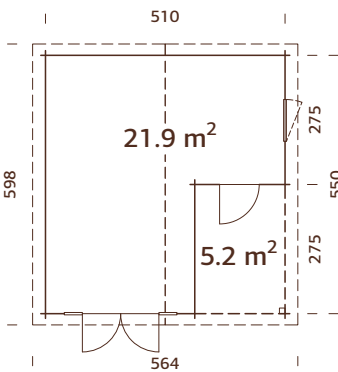

Double glazed.
Can be built in reverse!
Strong purlins from laminated wood.



TREATMENT

- Available dipped

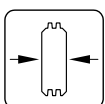

44 mm

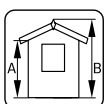

A: 228 cm
B: 321 cm

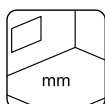

Included
19 mm

MODEL SPECIFICATIONS

Log measurements:

530x570 cm

Volume: 60,0 m³

Door/window type: Garden+

Window glass:

Double glass, 3-6-3 mm

Door glass: Double

toughened glass, 4-6-4 mm

Window opening

measurements: 78x89 cm

Door opening

measurements: 73x175 cm,
114x186 cm

Door sill: low, covered with

stainless steel

Roof boards: 19 mm

Roof area: 35,4 m²

Roof gradient: 18,7°

Gross ground area: 28,1 m²

OPTIONAL

Roofing felt (underlayer): 7 rolls, SBS roofing material: 7 rolls, shingles: 14 packs, roofing nails, rain gutters, extension, canopy roof, additional door and window.

PALMAKO CABIN IRENE 23,9 m²

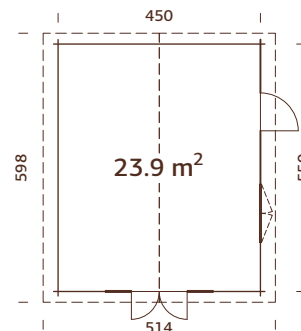

Double glazed.
Strong purlins from laminated wood.

MODEL SPECIFICATIONS

Log measurements:

470x570 cm

Volume: 59,0 m³

Door/window type: Garden+

Window glass:

Double glass, 3-6-3 mm

Door glass: Double

toughened glass, 4-6-4 mm

Window opening

measurements: 119x89 cm

Door opening

measurements: 73x175 cm,

114x186 cm

Door sill: low, covered with

stainless steel

Roof boards: 19 mm

Roof area: 31,7 m²

Roof gradient: 15,9°

Gross ground area: 24,8 m²

TREATMENT

Available dipped

Available painted

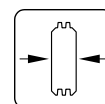

44 mm

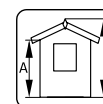

A: 217 cm
B: 287 cm

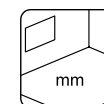

Included
19 mm

OPTIONAL

Roofing felt (underlayer): 7 rolls, SBS roofing material: 7 rolls, shingles: 12 packs, roofing nails, rain gutters, extension, canopy roof, additional door and window.

PALMAKO CABIN IRENE 27,7 m²

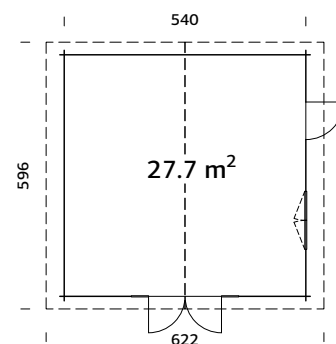

Double glazed.
Strong purlins from laminated wood.

MODEL SPECIFICATIONS

Log measurements:

560x560 cm

Volume: 73,9 m³

Door/window type: Summer

Window glass:

Double glass, 3-9-3 mm

Door glass: Double

toughened glass, 4-9-4 mm

Window opening

measurements: 117x92 cm

Door opening

measurements: 73x183 cm,

114x186 cm

Door sill: low, covered with

stainless steel

Roof boards: 19 mm

Roof area: 37,8 m²

Roof gradient: 15,7°

Gross ground area: 29,2 m²

TREATMENT

Available dipped

Available painted

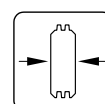

70 mm

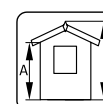

A: 230 cm
B: 312 cm

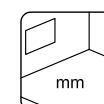

Included
19 mm

OPTIONAL

Roofing felt (underlayer): 8 rolls, SBS roofing material: 8 rolls, shingles: 14 packs, roofing nails, rain gutters, extension, canopy roof, additional door and window.

PALMAKO CABIN IRENE 19,0+16,2 m²



NEW!

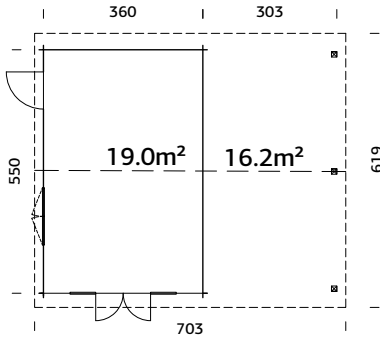

Double glazed.
Can be built in reverse!
Strong purlins from laminated wood

TREATMENT

- Available dipped
- Available painted

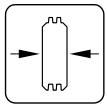

44 mm

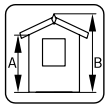

A: 222 cm
B: 316 cm

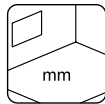

Included
19 mm

MODEL SPECIFICATIONS

Log measurements:

673x570 cm

Volume: 46,0+43,5 m³

Door/window type: Garden+

Window glass:

Double glass, 3-6-3 mm

Door glass:

Double toughened glass, 4-6-4 mm

Window opening

measurements: 119x89 cm

Door opening

measurements: 73x175 cm,
114x186 cm

Door sill: low, covered with stainless steel

Roof boards: 19 mm

Roof area: 45,0 m²

Roof gradient: 17,4°

Gross ground area: 36,5 m²

OPTIONAL

Roofing felt (underlayer): 8 rolls, SBS roofing material: 8 rolls, shingles: 18 packs, roofing nails, rain gutters, extension, canopy roof, additional door and window.

PALMAKO GABLE ROOF CABINS 40-77

PALMAKO CABIN IRENE 19,0+33,2 m²



NEW!

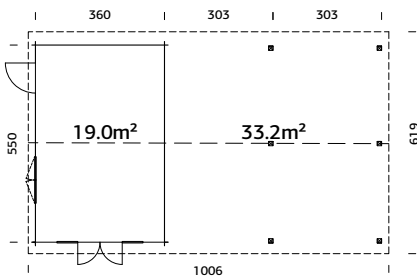

Double glazed.
Can be built in reverse!
Strong purlins from laminated wood

TREATMENT

- Available dipped
- Available painted

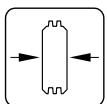

44 mm

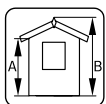

A: 222 cm
B: 316 cm

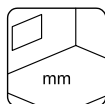

Included
19 mm

MODEL SPECIFICATIONS

Log measurements:

976x570 cm

Volume: 46,0+90,0 m³

Door/window type: Garden+

Window glass:

Double glass, 3-6-3 mm

Door glass:

Double toughened glass, 4-6-4 mm

Window opening

measurements: 119x89 cm

Door opening

measurements: 73x175 cm,
114x186 cm

Door sill: low, covered with stainless steel

Roof boards: 19 mm

Roof area: 45,0 m²

Roof gradient: 17,4°

Gross ground area: 53,1 m²

OPTIONAL

Roofing felt (underlayer): 10 rolls, SBS roofing material: 10 rolls, shingles: 24 packs, roofing nails, rain gutters, extension, canopy roof, additional door and window.

PALMAKO CABIN IRIS 9,6 m²

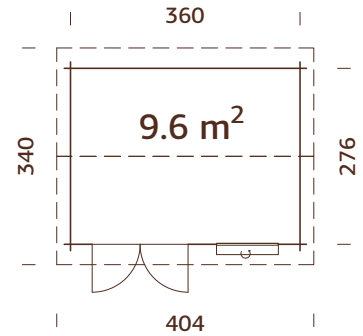

Includes door and window bars.

MODEL SPECIFICATIONS

Log measurements:

380x296 cm

Volume: 22,2 m³

Door/window type: Garden

Window glass:

Real glass, 4 mm

Door glass: Toughened glass, 4 mm

Window opening measurements: 66x111 cm

Door opening measurements: 151x175 cm

Door sill: low, covered with stainless steel

Roof boards: 16 mm

Roof area: 14,0 m²

Roof gradient: 16,2°

Gross ground area: 9,9 m²

TREATMENT

Available dipped

Available painted

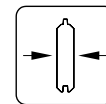

28 mm

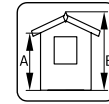

**A: 211 cm
B: 260 cm**

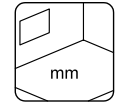

**Included
19 mm**

OPTIONAL

Roofing felt (underlayer): 3 rolls, SBS roofing material: 3 rolls, shingles: 6 packs, roofing nails, rain gutters, additional door and window.

PALMAKO CABIN IRIS 11,1 m²

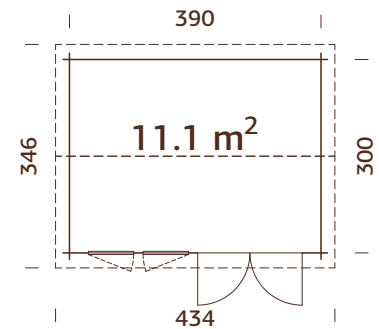

Double glazed.
Includes door and window bars.

MODEL SPECIFICATIONS

Log measurements:

410x320 cm

Volume: 25,3 m³

Door/window type: Summer

Window glass:

Double glass, 3-9-3 mm

Door glass: Double toughened glass, 4-9-4 mm

Window opening measurements: 53x104 cm

Door opening measurements: 144x172 cm

Door sill: low, covered with stainless steel

Roof boards: 19 mm

Roof area: 15,1 m²

Roof gradient: 13,2°

Gross ground area: 11,7 m²

TREATMENT

Available dipped

Available painted

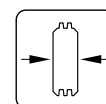

44 mm

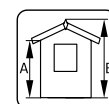

**A: 211 cm
B: 252 cm**

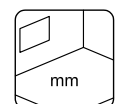

**Included
19 mm**

OPTIONAL

Roofing felt (underlayer): 3 rolls, SBS roofing material: 3 rolls, roofing nails, rain gutters, extension, canopy roof, additional door and window.

PALMAKO CABIN IRIS 19,1 m²

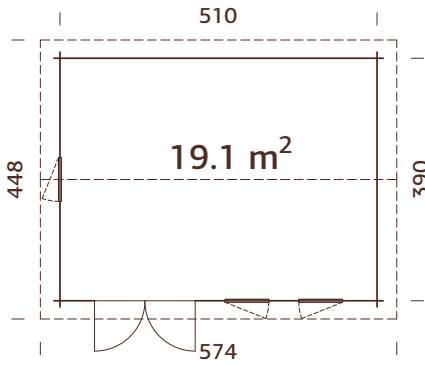

Double glazed.
Strong purlins from laminated wood.
Includes door and window bars.

TREATMENT

- Available dipped
- Available painted

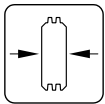

44 mm

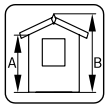

A: 211 cm
B: 262 cm

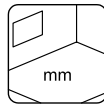

Included
19 mm

MODEL SPECIFICATIONS

Log measurements:

530x410 cm

Volume: 45,2 m³

Door/window type: Summer

Window glass:

Double glass, 3-9-3 mm

Door glass:

Double toughened glass, 4-9-4 mm

Window opening

measurements: 53x104 cm

Door opening

measurements: 144x172 cm

Door sill:

low, covered with stainless steel

Roof boards: 19 mm

Roof area: 26,2 m²

Roof gradient: 15,1°

Gross ground area: 19,9 m²

OPTIONAL

Roofing felt (underlayer): 6 rolls, SBS roofing material: 6 rolls, shingles: 11 packs, roofing nails, rain gutters, extension, canopy roof, additional door and window.

PALMAKO CABIN CLAUDIA 14,2 m²

NEW!

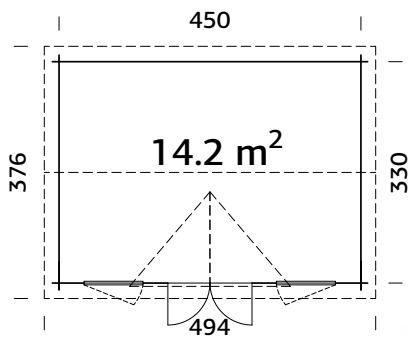

Double glazed.
Includes door and window bars.

TREATMENT

- Available dipped
- Available painted

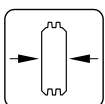

44 mm

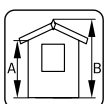

A: 219 cm
B: 337 cm

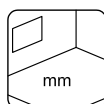

Included
19 mm

MODEL SPECIFICATIONS

Log measurements:

470x350 cm

Volume: 39,1 m³

Door/window type: Summer

Window glass:

Double glass, 3-9-3 mm

Door glass:

Double toughened glass, 4-9-4 mm

Window opening

measurements: 71x104 cm

Door opening

measurements: 144x172 cm

Door sill:

low, covered with stainless steel

Roof boards: 19 mm

Roof area: 23,4 m²

Roof gradient: 35,2°

Gross ground area: 14,9 m²

OPTIONAL

Roofing felt (underlayer): 3 rolls, SBS roofing material: 3 rolls, shingles: 9 packs, roofing nails, rain gutters, extension, canopy roof, additional door and window.

PALMAKO CABIN CLAUDIA 11,5 m²



Includes door and window bars.

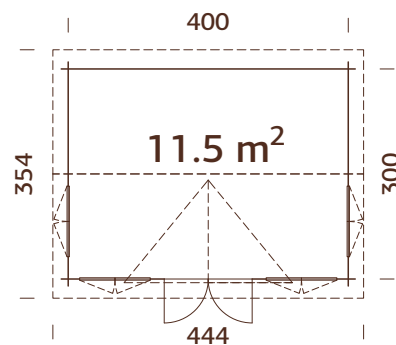

MODEL SPECIFICATIONS

Log measurements:

420x320 cm

Volume: 32,9 m³

Door/window type: Garden

Window glass:

Real glass, 4 mm

Door glass: Toughened glass, 4 mm

Window opening measurements: 90x123 cm

Door opening measurements: 114x186 cm

Door sill: low, covered with stainless steel

Roof boards: 19 mm

Roof area: 21,0 m²

Roof gradient: 35,2°

Gross ground area: 12,0 m²

TREATMENT

Available dipped

Available painted

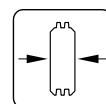

34 mm

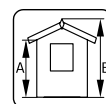

A: 234 cm

B: 347 cm

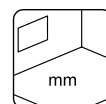

Included

19 mm

OPTIONAL

Roofing felt (underlayer): 3 rolls, SBS roofing material: 3 rolls, shingles: 9 packs, roofing nails, rain gutters, extension, canopy roof, additional door and window.

PALMAKO CABIN CLAUDIA 19,4 m²



Includes door and window bars.

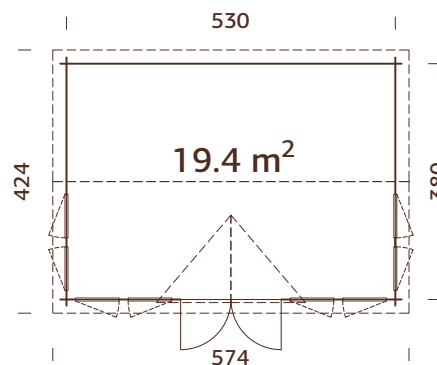

Double glazed.

MODEL SPECIFICATIONS

Log measurements:

550x400 cm

Volume: 55,6 m³

Door/window type: Summer

Window glass:

Double glass, 3-9-3 mm

Door glass: Double toughened glass, 4-9-4 mm

Window opening measurements: 53x104 cm

Door opening measurements: 144x172 cm

Door sill: low, covered with stainless steel

Roof boards: 19 mm

Roof area: 29,6 m²

Roof gradient: 35,2°

Gross ground area: 20,1 m²

TREATMENT

Available dipped

Available painted

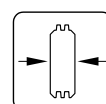

44 mm

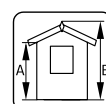

A: 222 cm

B: 363 cm

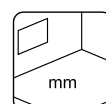

Included

19 mm

OPTIONAL

Roofing felt (underlayer): 7 rolls, SBS roofing material: 7 rolls, shingles: 12 packs, roofing nails, rain gutters, extension, canopy roof, additional door and window.

PALMAKO CABIN CLAUDIA PENT 11,5 m²

NEW!

under 2,5m

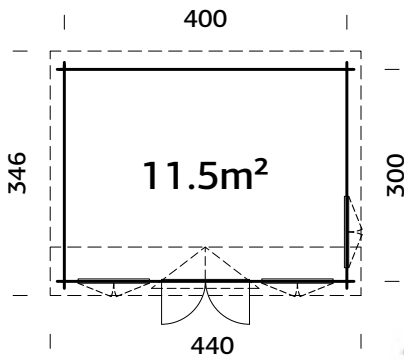

Double glazed.

Includes door and window bars.

TREATMENT

- Available dipped
- Available painted

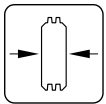

34 mm

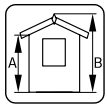

A: 210 cm
B: 249 cm

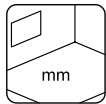

Included
19 mm

MODEL SPECIFICATIONS

Log measurements:

420x320 cm

Volume: 25,7 m³

Door/window type: Garden+

Door/window glass:

Double glass, 3-6-3 mm

Window opening

measurements: 90x123 cm

Door opening

measurements: 114x175 cm

Door sill: low, covered with stainless steel

Roof boards: 19 mm

Roof area: 15,9 m²

Roof gradient: 10,4°

Gross ground area: 12,0 m²

OPTIONAL

Roofing felt (underlayer): 3 rolls, SBS roofing material: 3 rolls, roofing nails, EPDM, rain gutters, extension, canopy roof, additional door and window.

PALMAKO CABIN CLAUDIA PENT 19,4 m²

NEW!

under 2,5m

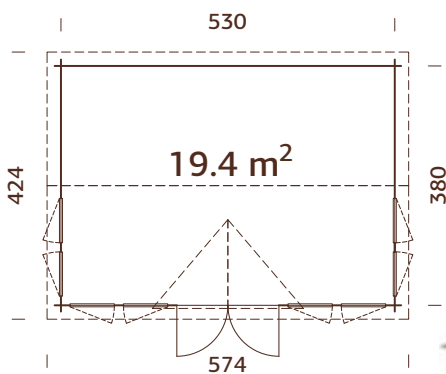

Double glazed.

Includes door and window bars.

TREATMENT

- Available dipped
- Available painted

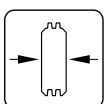

44 mm

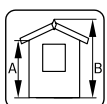

A: 211 cm
B: 249 cm

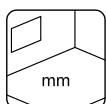

Included
19 mm

MODEL SPECIFICATIONS

Log measurements:

550x400 cm

Volume: 43,2 m³

Door/window type: Summer

Window glass:

Double glass, 3-9-3 mm

Door glass:

Double toughened glass, 4-9-4 mm

Window opening

measurements: 53x104 cm

Door opening

measurements: 144x172 cm

Door sill: low, covered with stainless steel

Roof boards: 19 mm

Roof area: 25,2 m²

Roof gradient: 7,9°

Gross ground area: 20,1 m²

OPTIONAL

Roofing felt (underlayer): 6 rolls, SBS roofing material: 6 rolls, roofing nails, EPDM, rain gutters, extension, canopy roof, additional door and window.

PALMAKO CABIN INES 11,1 m²

under
2,5m

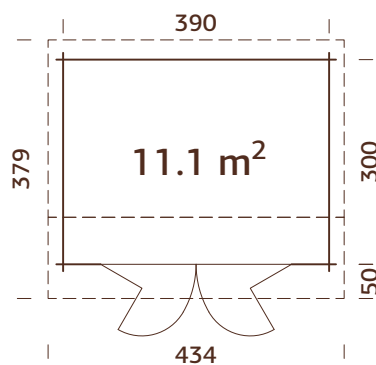

Bifold doors.
Double glazed.

MODEL SPECIFICATIONS

Log measurements:

410x320 cm

Volume: 25,5 m³

Door/window type: Garden+

Door/window glass: Double toughened glass, 4-6-4 mm

Bi-fold door opening

measurements: 263x184 cm

Door sill: low, covered with stainless steel

Roof boards: 19 mm

Roof area: 16,3 m²

Roof gradient: 8,0°; 8,0°

Gross ground area: 11,7 m²

TREATMENT

Available dipped

Available painted

OPTIONAL

Roofing felt (underlayer): 3 rolls, SBS roofing material: 3 rolls, roofing nails, EPDM, rain gutters, extension, additional door.

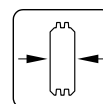

44 mm

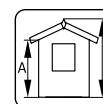

A: 211 cm
B: 249 cm

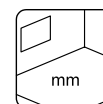

Included
19 mm

PALMAKO GABLE
ROOF CABINS

40-77



Ines 11,1 m² Slide

under
2,5m

PALMAKO CABIN INES 11,1 m²

SLIDE / SLIDE PLUS

PALMAKO GABLE
ROOF CABINS
40-77

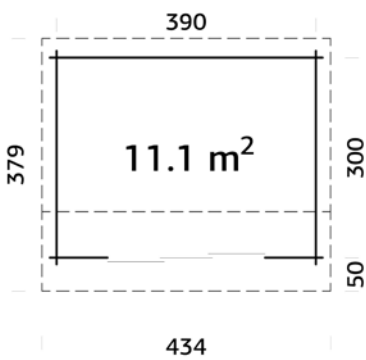

MODEL SPECIFICATIONS

Log measurements: 410x320 cm

Volume: 25,5 m³

**Sliding door opening measurements
(three sheets):** 176x187 cm (Slide),
172x185 cm (Slide Plus)

Roof boards: 19 mm

Roof area: 16,3 m²

Roof gradient: 8,0°; 8,0°

Gross ground area: 11,7 m²

OPTIONAL

Roofing felt (underlayer): 3 rolls, SBS roofing material: 3 rolls, roofing nails, EPDM, rain gutters, extension.

TREATMENT

Available dipped

Available painted

Sliding doors included.

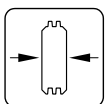

44 mm

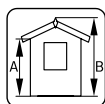

A: 211 cm

B: 249 cm

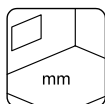

Included

19 mm



Slide

Single glass, toughened, 4 mm



Slide Plus

Double glass, toughened, 4-16-4 mm

PALMAKO CABIN INES 13,7 m²

under
2,5m

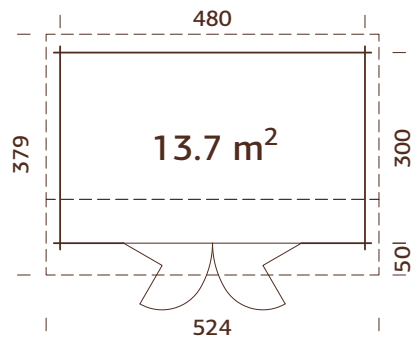

Bifold doors.
Double glazed.
Strong purlins from laminated wood.

MODEL SPECIFICATIONS

Log measurements:

500x320 cm

Volume: 31,6 m³

Door/window type: Garden+

Door/window glass: Double toughened glass, 4-6-4 mm

Bi-fold door opening

measurements: 263x184 cm

Door sill: low, covered with stainless steel

Roof boards: 19 mm

Roof area: 19,7 m²

Roof gradient: 8,0°; 8,0°

Gross ground area: 14,4 m²

TREATMENT

Available dipped

Available painted

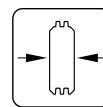

44 mm

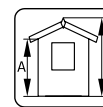

A: 211 cm
B: 249 cm

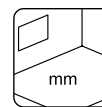

Included
19 mm

OPTIONAL

Roofing felt (underlayer): 5 rolls, SBS roofing material: 5 rolls, roofing nails, EPDM, rain gutters, extension, additional door.

PALMAKO GABLE
ROOF CABINS
40-77



Ines 13,7 m² Slide

under
2,5m

PALMAKO CABIN INES 13,7 m²

SLIDE / SLIDE PLUS

PALMAKO GABLE
ROOF CABINS
40-77

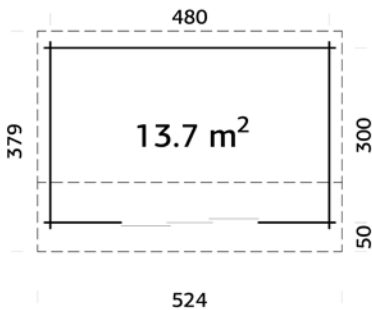

MODEL SPECIFICATIONS

Log measurements: 500x320 cm

Volume: 31,6 m³

**Sliding door opening measurements
(three sheets):** 176x187 cm (Slide),
172x185 cm (Slide Plus)

Roof boards: 19 mm

Roof area: 19,7 m²

Roof gradient: 8,0°; 8,0°

Gross ground area: 14,4 m²

OPTIONAL

Roofing felt (underlayer): 5 rolls, SBS roofing material: 5 rolls, roofing nails, EPDM, rain gutters, extension.

TREATMENT

Available dipped

Available painted

Sliding doors included.

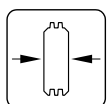

44 mm

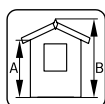

A: 211 cm

B: 249 cm

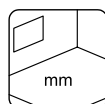

Included

19 mm



Slide

Single glass, toughened, 4 mm



Slide Plus

Double glass, toughened, 4-16-4 mm

PALMAKO CABIN AMANDA 11,2 m²

SLIDE / SLIDE PLUS



NEW!



Can be built in reverse!

PALMAKO GABLE
ROOF CABINS
40-77

MODEL SPECIFICATIONS

Log measurements: 390x300 cm

Volume: 26,7 m³

Sliding door opening measurements

(two sheets): 88x187 cm (Slide),

85x185 cm (Slide Plus)

Sliding door opening measurements

(three sheets): 176x187 cm (Slide),

172x185 cm (Slide Plus)

Roof boards: 19 mm

Roof area: 15,1 m²

Roof gradient: 17,2°

Gross ground area: 11,7 m²

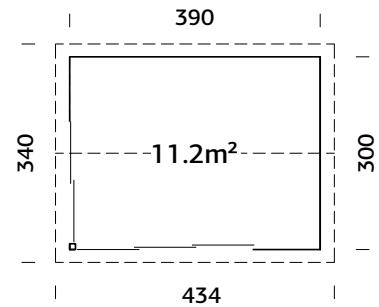

OPTIONAL

Roofing felt (underlayer): 3 rolls, SBS roofing material: 3 rolls, shingles: 6 packs, roofing nails, rain gutters.



Slide
Single glass, toughened, 4 mm



Slide Plus
Double glass, toughened, 4-16-4 mm

Modern corner connection.
Sliding doors included.

TREATMENT

Available dipped

Available painted

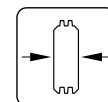

44 mm

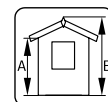

A: 228 cm
B: 280 cm

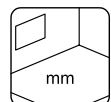

Included
19 mm

PALMAKO CABIN AMANDA 11,2+7,8 m²

SLIDE / SLIDE PLUS



NEW!



Can be built in reverse!

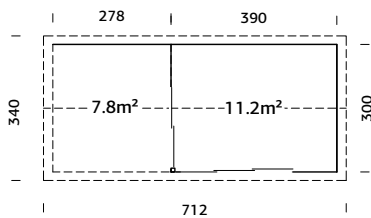

MODEL SPECIFICATIONS

Log measurements: 668x300 cm

Volume: 26,7+20,5 m³

Sliding door opening measurements

(two sheets): 88x187 cm (Slide),

85x185 cm (Slide Plus)

Sliding door opening measurements

(three sheets): 176x187 cm (Slide),

172x185 cm (Slide Plus)

Roof boards: 19 mm

Roof area: 25,0 m²

Roof gradient: 17,2°

Gross ground area: 20,4 m²

OPTIONAL

Roofing felt (underlayer): 5 rolls, SBS roofing material: 5 rolls, shingles: 10 packs, roofing nails, rain gutters.

- Modern corner connection.
- Sliding doors included.
- Strong posts from laminated wood.

TREATMENT

Available dipped

Available painted

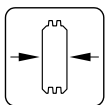

44 mm

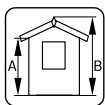

A: 228 cm

B: 280 cm

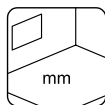

Included

19 mm



Slide

Single glass, toughened, 4 mm



Slide Plus

Double glass, toughened, 4-16-4 mm

PALMAKO CABIN AMANDA 17,1 m²

SLIDE / SLIDE PLUS



NEW!



Can be built in reverse!

MODEL SPECIFICATIONS

Log measurements: 595x300 cm

Volume: 42,9 m³

Sliding door opening measurements

(two sheets): 88x187 cm (Slide),

85x185 cm (Slide Plus)

Fixed window measurements: 83x160 cm

Sliding door opening measurements

(three sheets): 176x187 cm (Slide),

172x185 cm (Slide Plus)

Roof boards: 19 mm

Roof area: 23,6 m²

Roof gradient: 17,2°

Gross ground area: 17,9 m²

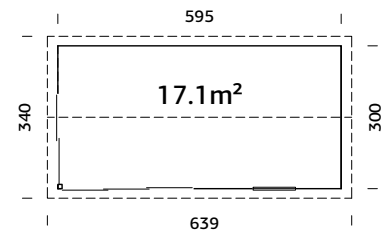

OPTIONAL

Roofing felt (underlayer): 5 rolls, SBS roofing material: 5 rolls, shingles: 10 packs, roofing nails, rain gutters, additional window.

Modern corner connection.

Sliding doors included.



Slide

Single glass, toughened, 4 mm



Slide Plus

Double glass, toughened, 4-16-4 mm

TREATMENT

Available dipped

Available painted

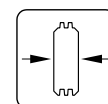

44 mm

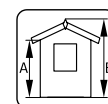

A: 228 cm

B: 280 cm

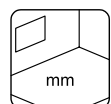

Included

19 mm

PALMAKO CABIN AMANDA 17,1+7,8 m²

SLIDE / SLIDE PLUS



NEW!



PALMAKO GABLE ROOF CABINS 40-77



Can be built in reverse!

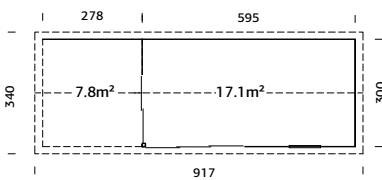

MODEL SPECIFICATIONS

Log measurements: 873x300 cm

Volume: 42,9+20,5 m³

Sliding door opening measurements

(two sheets): 88x187 cm (Slide),

85x185 cm (Slide Plus)

Fixed window measurements: 83x160 cm

Sliding door opening measurements

(three sheets): 176x187 cm (Slide),

172x185 cm (Slide Plus)

Roof boards: 19 mm

Roof area: 32,2 m²

Roof gradient: 17,2°

Gross ground area: 26,2 m²

OPTIONAL

Roofing felt (underlayer): 5 rolls, SBS roofing material: 5 rolls, shingles: 13 packs, roofing nails, rain gutters, additional window.

Modern corner connection.
Sliding doors included.
Strong posts from laminated wood.

TREATMENT

Available dipped

Available painted

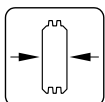

44 mm

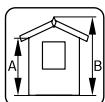

A: 228 cm

B: 280 cm

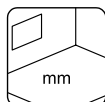

Included

19 mm



Slide

Single glass, toughened, 4 mm



Slide Plus

Double glass, toughened, 4-16-4 mm

OPTIONAL PRODUCTS

SEE OPTIONAL PRODUCTS, PAGES 344-368

House	Art. No.	Floor ¹	Roofing felt, rolls	SBS roofing material, rolls	Shingles ² , packs	Roofing nails, 1 kg	Rain gutters	Extension	Canopy roof
Vivian 3,8 m ²	101314		107210, 1 roll	107214, 1 roll	3 packs	107930	106629		
Vivian 6,9 m ²	101523		107210, 2 rolls	107214, 2 rolls	5 packs	107930	106629		
Lotta 7,3 m ²	101482	102971	107210, 3 rolls	107214, 3 rolls	5 packs	107930	106630	102801	103168
Lotta 10,0 m ²	101646	102986	107210, 3 rolls	107214, 3 rolls	6 packs	107930	106631		103168
Lotta 13,9 m ²	101694	103030	107210, 3 rolls	107214, 3 rolls	8 packs	107930	106631		103168
Klara 4,7 m ²	101827	102975	107210, 2 rolls	107214, 2 rolls	4 packs	107930	106629		
Klara 10,4 m ²	101990	103011	107210, 3 rolls	107214, 3 rolls	6 packs	107930	106630	102801	103168
Klara 17,0 m ²	102130	103062	107210, 4 rolls	107214, 4 rolls	10 packs	2 x 107930	106631		103168
Valentine 4,7 m ²	109452	109456	107210, 2 rolls	107214, 2 rolls	4 packs	107930	106629		103168
Valentine 6,1 m ²	109454	109522	107210, 2 rolls	107214, 2 rolls	4 packs	107930	106629	102801	103168
Valentine 9,0 m ²	109458	109518	107210, 3 rolls	107214, 3 rolls	6 packs	107930	106630	102801	103168
Valentine 11,0 m ²	109527	109520	107210, 3 rolls	107214, 3 rolls	7 packs	107930	106630	102801	103168
Britta 14,6 m ²	102072	103038	107210, 7 rolls	107214, 7 rolls	10 packs	2 x 107930	106632	102801	103168
Britta 17,5 m ²	102252	103050	107210, 7 rolls	107214, 7 rolls	11 packs	2 x 107930	106632	102801	103168
Britta 19,7 m ²	102262	103066	107210, 7 rolls	107214, 7 rolls	12 packs	2 x 107930	106632	102801	103168
Britta 22,3 m ²	102266	103070	107210, 7 rolls	107214, 7 rolls	12 packs	2 x 107930	106632	102801	103168

¹ Includes treated joists. ² Shingles are available in different colours - 107180 = Black, 107182 = Red, 107183 = Green, 107181 = Brown. The article number is indicated to untreated items, for treated items ask our sales team.

OPTIONAL PRODUCTS

SEE OPTIONAL PRODUCTS, PAGES 344-368

House	Art. No.	Floor ¹	Roofing felt, rolls	SBS roofing material, rolls	Shingles ² , packs	Roofing nails, 1 kg	Rain gutters	Extension	Canopy roof
Emma 4,6 m ²	101797								
			107210, 2 rolls	107214, 2 rolls	4 packs	107930	106629		
Emma 10,4 m ²	102033		107210, 3 rolls	107214, 3 rolls	7 packs	107930	106630	102801	103168
Emma 10,4+4,2 m ²	101885		107210, 5 rolls	107214, 5 rolls	8 packs	107930	106631	102801	103168
Emma 14,2 m ²	102339		107210, 4 rolls	107214, 4 rolls	9 packs	107930	106631		
Sally 10,2 m ²	102270		107210, 3 rolls	107214, 3 rolls	7 packs	107930	106631	102801	103168
Sally 12,3 m ²	102083		107210, 6 rolls	107214, 6 rolls	9 packs	107930	106632	102801	103168
Sally 15,5 m ²	102274		107210, 7 rolls	107214, 7 rolls	11 packs	2 x 107930	106632	102801	103168
Sally 19,1 m ²	102312		107210, 8 rolls	107214, 8 rolls	13 packs	2 x 107930	106632	102801	103168
Helena 15,1 m ²	102318		107210, 7 rolls	107214, 7 rolls	11 packs	2 x 107930	106632	102801	103168
Helena 18,6 m ²	102511		107210, 8 rolls	107214, 8 rolls	13 packs	2 x 107930	106632	102801	103168
Helena 24,6 m ²	102515		107210, 8 rolls	107214, 8 rolls	16 packs	2 x 107930	2 x 106630	102801	103168
Susanna 12,4 m ²	102465		107210, 5 rolls	107214, 5 rolls	9 packs	2 x 107930	106632		
Susanna 16,4 m ²	102469		107210, 6 rolls	107214, 6 rolls	10 packs	2 x 107930	106632		

¹ Includes treated joists. ² Shingles are available in different colours - 107180 = Black, 107182 = Red, 107183 = Green, 107181 = Brown. The article number is indicated to untreated items, for treated items ask our sales team.

OPTIONAL PRODUCTS

SEE OPTIONAL PRODUCTS, PAGES 344-368

House	Art. No.	Floor ¹	Roofing felt, rolls	SBS roofing material, rolls	Shingles ² , packs	EPDM	Roofing nails, 1 kg	Rain gutters	Extension	Canopy roof
Irene 19,0 m ²	102351		107210, 6 rolls	107214, 6 rolls	10 packs		2 x 107930	106632	102801	103168
Irene 23,9 m ²	102367		107210, 7 rolls	107214, 7 rolls	12 packs		2 x 107930	106632	102801	103168
Irene 21,9+5,2 m ²	102490		107210, 7 rolls	107214, 7 rolls	14 packs		2 x 107930	106632	102801	103168
Irene 27,7 m ²	102375		107210, 8 rolls	107214, 8 rolls	14 packs		2 x 107930	106632	102801	103168
Irene 19,0+16,2 m ²	120066		107210, 8 rolls	107214, 8 rolls	18 packs		2 x 107930	106630	102801	103168
Irene 19,0+33,2 m ²	120070		107210, 10 rolls	107214, 10 rolls	24 packs		3 x 107930	106632	102801	103168
Iris 9,6 m ²	101978		107210, 3 rolls	107214, 3 rolls	6 packs		107930	106630		
Iris 11,1 m ²	102185		107210, 3 rolls	107214, 3 rolls			107930	106631	102801	103168
Iris 19,1 m ²	102214		107210, 6 rolls	107214, 6 rolls	11 packs		2 x 107930	106632	102801	103168
Claudia 14,2 m ²	119361		107210, 3 rolls	107214, 3 rolls	9 packs		107930	106631		
Claudia 11,5 m ²	102519		107210, 3 rolls	107214, 3 rolls	9 packs		107930	106631	102801	103168
Claudia 19,4 m ²	102387		107210, 7 rolls	107214, 7 rolls	12 packs		2 x 107930	106632	102801	103168
Claudia Pent 11,5 m ²	119350		107210, 3 rolls	107214, 3 rolls		2 x 111847	107930	106631		
Claudia Pent 19,4 m ²	119337		107210, 6 rolls	107214, 6 rolls		3 x 111847	107930	106632		

¹ Includes treated joists. ² Shingles are available in different colours - 107180 = Black, 107182 = Red, 107183 = Green, 107181 = Brown. The article number is indicated to untreated items, for treated items ask our sales team.

OPTIONAL PRODUCTS

SEE OPTIONAL PRODUCTS, PAGES 344-368

House	Art. No.	Floor ¹	Roofing felt, rolls	SBS roofing material, Shingles ² , packs	EPDM	Roofing nails, 1 kg	Rain gutters	Extension	Canopy roof
Lines 11.1 m ²	101724		107210, 3 rolls	107214, 3 rolls	2 x 111847	107950	106631	102801	
Lines 13.7 m ²	101732		107210, 5 rolls	107214, 5 rolls	2 x 111847	107950	106632	102801	
Lines 11.1 m ² Slide	111171		107210, 3 rolls	107214, 3 rolls	2 x 111847	107950	106631	102801	
Lines 11.1 m ² Slide Plus	111175		107210, 3 rolls	107214, 3 rolls	2 x 111847	107950	106631	102801	
Lines 13.7 m ² Slide	111179		107210, 5 rolls	107214, 5 rolls	2 x 111847	107950	106632	102801	
Lines 13.7 m ² Slide Plus	111183		107210, 5 rolls	107214, 5 rolls	2 x 111847	107950	106632	102801	
Amanda 11.2 m ² Slide	120034		107210, 3 rolls	107214, 3 rolls		107950	106631		
Amanda 11.2 m ² Slide Plus	120038		107210, 3 rolls	107214, 3 rolls	6 packs	107950	106631		
Amanda 11.2+7.8 m ² Slide	120042		107210, 5 rolls	107214, 5 rolls	10 packs	107950	106630		
Amanda 11.2+7.8 m ² Slide Plus	120046		107210, 5 rolls	107214, 5 rolls	10 packs	107950	106630		
Amanda 17.1 m ² Slide	120050		107210, 5 rolls	107214, 5 rolls	10 packs	107950	106630 + 106629		
Amanda 17.1 m ² Slide Plus	120054		107210, 5 rolls	107214, 5 rolls	10 packs	107950	106630 + 106629		
Amanda 17.1+7.8 m ² Slide	120058		107210, 5 rolls	107214, 5 rolls	13 packs	2 x 107930	2 x 106631		
Amanda 17.1+7.8 m ² Slide Plus	120062		107210, 5 rolls	107214, 5 rolls	13 packs	2 x 107930	2 x 106631		

¹ Includes treated joists.

² Shingles are available in different colours - 107180 = Black, 107182 = Red, 107183 = Green, 107181 = Brown. The article number is indicated to untreated items, for treated items ask our sales team.



Andrea 11,2+7,9 m² Slide



PALMAKO FLAT
ROOF CABINS

78-103

CABINS

Flat roof

FLAT ROOF CABINS



PALMAKO CABIN
ALICE 4,7 m²



PALMAKO CABIN
ALICE 6,1 m²



PALMAKO CABIN
ALICE 9,0 m²



PALMAKO CABIN
ALICE 11,0 m²



PALMAKO CABIN
ELLA 6,9 m²



PALMAKO CABIN
ELLA 6,9+8,2 m²



PALMAKO CABIN
ELLA 6,9+10,0 m²



PALMAKO CABIN
ELLA 8,7 m²



PALMAKO CABIN
ELLA 8,7+8,2 m²



PALMAKO CABIN
ELLA 8,7+10,0 m²



PALMAKO CABIN
ELLA 13,1 m²



PALMAKO CABIN
ELLA 13,1+3,9 m²



PALMAKO CABIN
LISA 11,5 m²



PALMAKO CABIN
LISA 14,2 m²



PALMAKO CABIN
LISA 19,4 m²

PALMAKO FLAT
ROOF CABINS
78-103



PALMAKO CABIN
LEA 14,2 m²



PALMAKO CABIN
LEA 19,4 m²



PALMAKO CABIN
LEA 14,2 m²
SLIDE / SLIDE PLUS



PALMAKO CABIN
LEA 19,4 m²
SLIDE / SLIDE PLUS



PALMAKO CABIN
BRET 14,8 m²



PALMAKO CABIN
BRET 19,9 m²



PALMAKO CABIN
ANDREA 7,5 m² SLIDE PLUS



PALMAKO CABIN
ANDREA 11,2 m²
SLIDE / SLIDE PLUS



PALMAKO CABIN
ANDREA 11,2+7,9 m²
SLIDE / SLIDE PLUS



PALMAKO CABIN
ANDREA 17,1 m²
SLIDE / SLIDE PLUS



PALMAKO CABIN
ANDREA 17,1+7,9 m²
SLIDE / SLIDE PLUS



PALMAKO CABIN
HEIDI 11,7 m²



PALMAKO CABIN
HEIDI 19,7 m²



PALMAKO CABIN
HEIDI 22,5 m²



PALMAKO CABIN
HEIDI 22,8 m²

PALMAKO CABIN ALICE 4,7 m²



under 2,5m

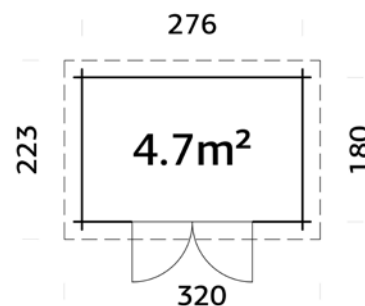

MODEL SPECIFICATIONS

Log measurements:

296x200 cm

Volume: 9,4 m³

Door/window type: Garden

Door glass: Real glass, 4 mm

Door opening

measurements: 139x175 cm

Door sill: low, covered with stainless steel

Roof boards: 16 mm

Roof area: 7,0 m²

Roof gradient: 7,3°

Gross ground area: 5,0 m²

TREATMENT



brown pressure-treated

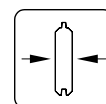

28 mm

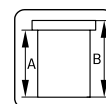

A: 188 cm
B: 216 cm

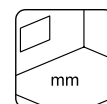

NB! Floor is an optional extra! 19 mm

OPTIONAL

Floor, roofing felt (underlayer): 1 roll, SBS roofing material: 1 roll, roofing nails, EPDM, rain gutters, canopy roof, additional door.

PALMAKO CABIN ALICE 6,1 m²



under 2,5m

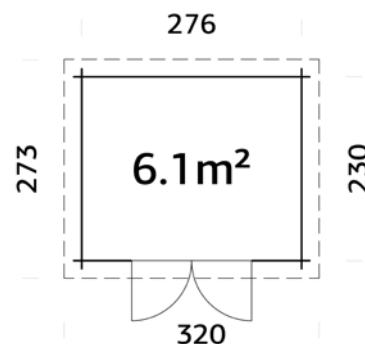

MODEL SPECIFICATIONS

Log measurements:

296x250 cm

Volume: 12,1 m³

Door/window type: Garden

Door glass: Real glass, 4 mm

Door opening

measurements: 139x175 cm

Door sill: low, covered with stainless steel

Roof boards: 16 mm

Roof area: 8,6 m²

Roof gradient: 5,7°

Gross ground area: 6,3 m²

TREATMENT



brown pressure-treated

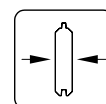

28 mm

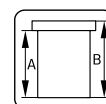

A: 188 cm
B: 216 cm

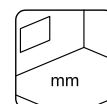

NB! Floor is an optional extra! 19 mm

OPTIONAL

Floor, roofing felt (underlayer): 2 rolls, SBS roofing material: 2 rolls, roofing nails, EPDM, rain gutters, extension, canopy roof, additional door.

PALMAKO CABIN ALICE 9,0 m²



under
2,5m

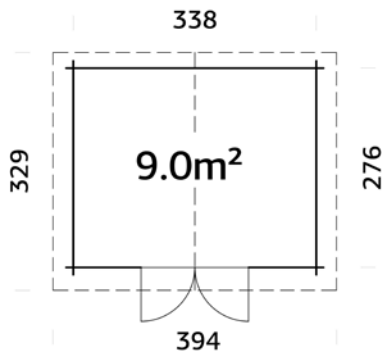

TREATMENT



brown pressure-treated

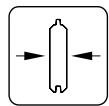

28 mm

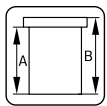

A: 188 cm
B: 215 cm

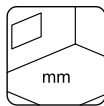

NB! Floor is an optional extra! 19 mm

MODEL SPECIFICATIONS

Log measurements:

358x296 cm

Volume: 18,0 m³

Door/window type: Garden

Door glass: Real glass, 4 mm

Door opening

measurements: 139x175 cm

Door sill: low, covered with

stainless steel

Roof boards: 16 mm

Roof area: 12,0 m²

Roof gradient: 5,0°

Gross ground area: 9,3 m²

OPTIONAL

Floor, roofing felt (underlayer): 2 rolls, SBS roofing material: 2 rolls, roofing nails, EPDM, rain gutters, extension, canopy roof, additional door.

PALMAKO CABIN ALICE 11,0 m²



under
2,5m

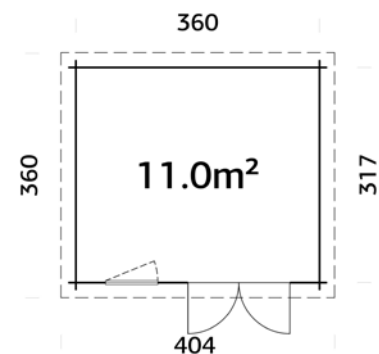

TREATMENT



brown pressure-treated

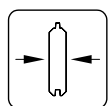

28 mm

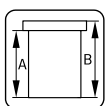

A: 188 cm
B: 227 cm

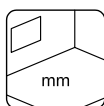

NB! Floor is an optional extra! 19 mm

MODEL SPECIFICATIONS

Log measurements:

380x337 cm

Volume: 22,7 m³

Door/window type: Garden

Door/window glass:

Real glass, 4 mm

Window opening

measurements: 66x89 cm

Door opening

measurements: 139x175 cm

Door sill: low, covered with

stainless steel

Roof boards: 16 mm

Roof area: 14,4 m²

Roof gradient: 6,2°

Gross ground area: 11,4 m²

OPTIONAL

Floor, roofing felt (underlayer): 3 rolls, SBS roofing material: 3 rolls, roofing nails, EPDM, rain gutters, extension, canopy roof, additional door and window.

PALMAKO CABIN ELLA 6,9 m²

under 2,5m

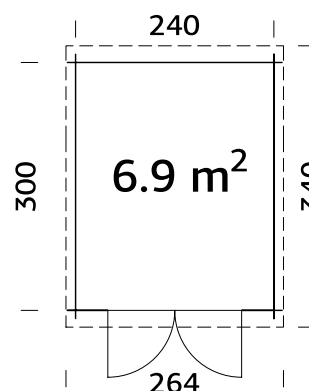

MODEL SPECIFICATIONS

Log measurements:

260x320 cm

Volume: 14,2 m³

Door/window type: Garden

Door glass: Toughened glass, 4 mm

Door opening

measurements: 151x175 cm

Door sill: low, covered with stainless steel

Roof boards: 19 mm

Roof area: 8,7 m²

Roof gradient: 2,2°

Gross ground area: 7,2 m²

TREATMENT

Available dipped

Available painted

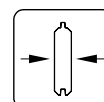

28 mm

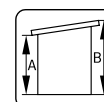

A: 199 cm
B: 214 cm

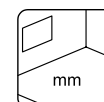

NB! Floor is an optional extra! 19 mm

OPTIONAL

Floor, roofing felt (underlayer): 2 rolls, SBS roofing material: 2 rolls, roofing nails, EPDM, rain gutters, additional door.

PALMAKO CABIN ELLA 8,7 m²

under 2,5m

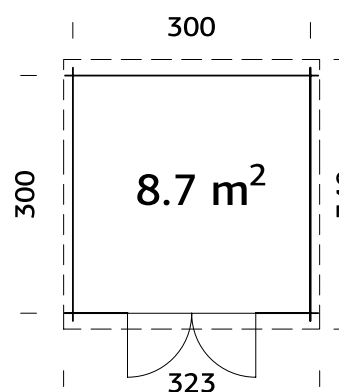

MODEL SPECIFICATIONS

Log measurements:

320x320 cm

Volume: 17,8 m³

Door/window type: Garden

Door glass: Toughened glass, 4 mm

Door opening

measurements: 151x175 cm

Door sill: low, covered with stainless steel

Roof boards: 19 mm

Roof area: 10,8 m²

Roof gradient: 2,2°

Gross ground area: 9,0 m²

TREATMENT

Available dipped

Available painted

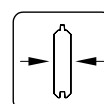

28 mm

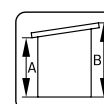

A: 199 cm
B: 214 cm

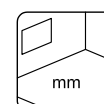

NB! Floor is an optional extra! 19 mm

OPTIONAL

Floor, roofing felt (underlayer): 3 rolls, SBS roofing material: 3 rolls, roofing nails, EPDM, rain gutters, additional door.

PALMAKO CABIN ELLA 6,9+8,2 m²

under
2,5m

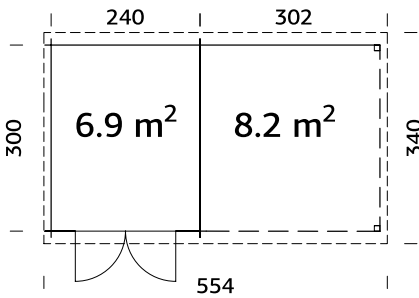

Can be built in reverse!



TREATMENT

- Available dipped
- Available painted

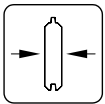

28 mm

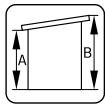

A: 199 cm
B: 214 cm

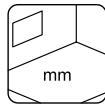

NB! Floor is an optional extra! 19 mm

MODEL SPECIFICATIONS

Log measurements:

550x320 cm

Volume: 14,2+16,6 m³

Door/window type: Garden

Door glass: Toughened glass, 4 mm

Door opening

measurements: 151x175 cm

Door sill: low, covered with stainless steel

Roof boards: 19 mm

Roof area: 18,5 m²

Roof gradient: 2,2°

Gross ground area: 15,9 m²

OPTIONAL

Floor, roofing felt (underlayer): 5 rolls, SBS roofing material: 5 rolls, roofing nails, EPDM, rain gutters, additional door.

PALMAKO CABIN ELLA 6,9+10,0 m²

under
2,5m

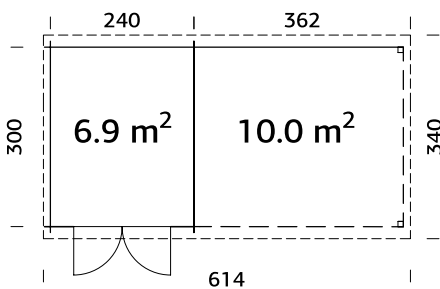

TREATMENT

- Available dipped
- Available painted

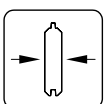

28 mm

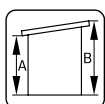

A: 199 cm
B: 214 cm

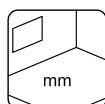

NB! Floor is an optional extra! 19 mm

MODEL SPECIFICATIONS

Log measurements:

610x320 cm

Volume: 14,2+19,9 m³

Door/window type: Garden

Door glass: Toughened glass, 4 mm

Door opening

measurements: 151x175 cm

Door sill: low, covered with stainless steel

Roof boards: 19 mm

Roof area: 20,5 m²

Roof gradient: 2,2°

Gross ground area: 17,7 m²

OPTIONAL

Floor, roofing felt (underlayer): 5 rolls, SBS roofing material: 5 rolls, roofing nails, EPDM, rain gutters, additional door.

PALMAKO CABIN ELLA 8,7+8,2 m²

under
2,5m

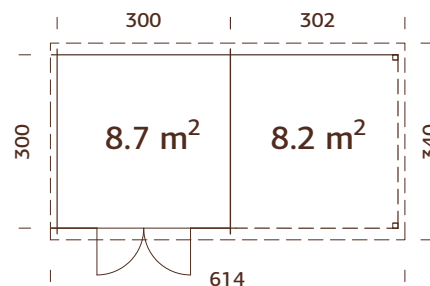

Can be built in reverse!

MODEL SPECIFICATIONS

Log measurements:

610x320 cm

Volume: 17,8+16,6 m³

Door/window type: Garden

Door glass: Toughened glass, 4 mm

Door opening

measurements: 151x175 cm

Door sill: low, covered with stainless steel

Roof boards: 19 mm

Roof area: 20,5 m²

Roof gradient: 2,2°

Gross ground area: 17,7 m²

TREATMENT

Available dipped

Available painted

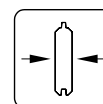

28 mm

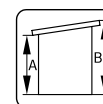

A: 199 cm
B: 214 cm

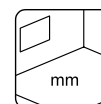

NB! Floor is an optional extra! 19 mm

OPTIONAL

Floor, roofing felt (underlayer): 5 rolls, SBS roofing material: 5 rolls, roofing nails, EPDM, rain gutters, additional door.

PALMAKO CABIN ELLA 8,7+10,0 m²

under
2,5m

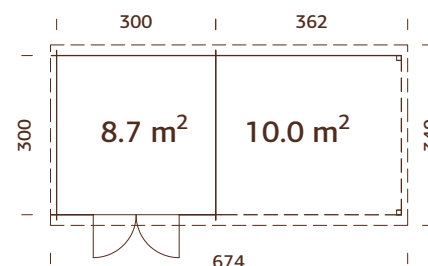

Can be built in reverse!

MODEL SPECIFICATIONS

Log measurements:

670x320 cm

Volume: 17,8+19,9 m³

Door/window type: Garden

Door glass: Toughened glass, 4 mm

Door opening

measurements: 151x175 cm

Door sill: low, covered with stainless steel

Roof boards: 19 mm

Roof area: 22,5 m²

Roof gradient: 2,2°

Gross ground area: 19,5 m²

TREATMENT

Available dipped

Available painted

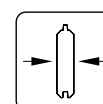

28 mm

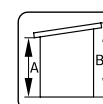

A: 199 cm
B: 214 cm

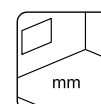

NB! Floor is an optional extra! 19 mm

OPTIONAL

Floor, roofing felt (underlayer): 5 rolls, SBS roofing material: 5 rolls, roofing nails, EPDM, rain gutters, additional door.

PALMAKO CABIN ELLA 13,1 m²

under 2,5m

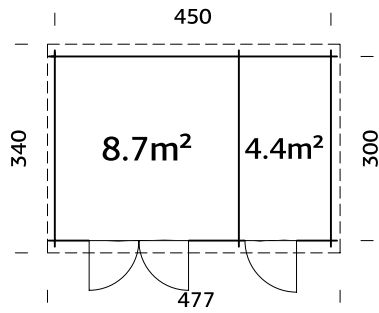

TREATMENT

- Available dipped
- Available painted

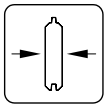

28 mm

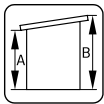

A: 199 cm
B: 214 cm

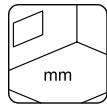

NB! Floor is an optional extra! 19 mm

MODEL SPECIFICATIONS

Log measurements:

470x320 cm

Volume: 26,8 m³

Door/window type: Garden

Door glass: Toughened glass, 4 mm

Door opening

measurements: 73x175, 151x175 cm

Door sill: low, covered with stainless steel

Roof boards: 19 mm

Roof area: 15,8 m²

Roof gradient: 2,2°

Gross ground area: 13,5 m²

OPTIONAL

Floor, roofing felt (underlayer): 3 rolls, SBS roofing material: 3 rolls, roofing nails, EPDM, rain gutters, additional door.

PALMAKO CABIN ELLA 13,1+3,9 m²

under 2,5m

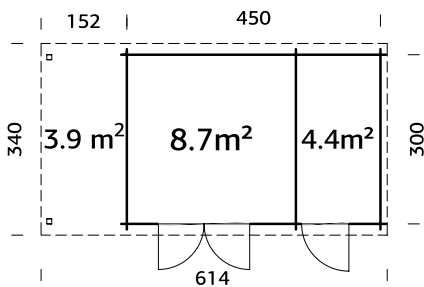

Can be built in reverse!



TREATMENT

- Available dipped
- Available painted

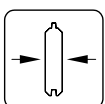

28 mm

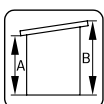

A: 199 cm
B: 214 cm

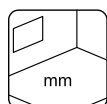

NB! Floor is an optional extra! 19 mm

MODEL SPECIFICATIONS

Log measurements:

610x320 cm

Volume: 26,8+8,0 m³

Door/window type: Garden

Door glass: Toughened glass, 4 mm

Door opening

measurements: 73x175, 151x175 cm

Door sill: low, covered with stainless steel

Roof boards: 19 mm

Roof area: 20,9 m²

Roof gradient: 2,2°

Gross ground area: 17,8 m²

OPTIONAL

Floor, roofing felt (underlayer): 5 rolls, SBS roofing material: 5 rolls, roofing nails, EPDM, rain gutters, additional door.

PALMAKO CABIN LISA 11,5 m²

under 2,5m

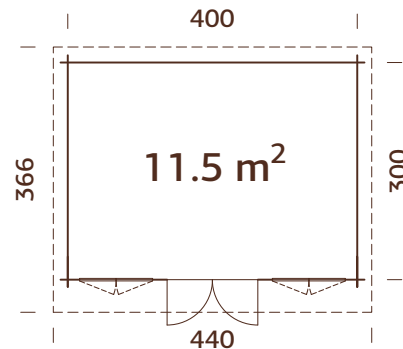

Includes door and window bars.



MODEL SPECIFICATIONS

Log measurements:

420x320 cm

Volume: 25,6 m³

Door/window type: Garden

Window glass:

Real glass, 4 mm

Door glass:

Toughened glass, 4 mm

Window opening

measurements: 90x123 cm

Door opening

measurements: 114x186 cm

Door sill: low, covered with

stainless steel

Roof boards: 19 mm

Roof area: 16,1 m²

Roof gradient: 4,4°

Gross ground area: 12,0 m²

TREATMENT

Available dipped

Available painted

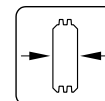

34 mm

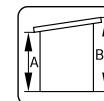

A: 211 cm
B: 234 cm

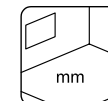

Included
19 mm

OPTIONAL

Roofing felt (underlayer): 3 rolls, SBS roofing material: 3 rolls, roofing nails, EPDM, rain gutters, extension, canopy roof, additional door and window.

PALMAKO CABIN LISA 14,2 m²

under 2,5m

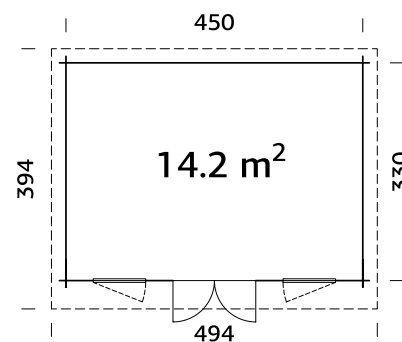

Double glazed.

Includes door and window bars.



MODEL SPECIFICATIONS

Log measurements:

470x350 cm

Volume: 31,6 m³

Door/window type: Summer

Window glass:

Double glass, 3-9-3 mm

Door glass: Double

toughened glass, 4-9-4 mm

Window opening

measurements: 53x104 cm

Door opening

measurements: 144x172 cm

Door sill: low,

covered with stainless steel

Roof boards: 19 mm

Roof area: 19,2 m²

Roof gradient: 4,0°

Gross ground area: 14,9 m²

TREATMENT

Available dipped

Available painted

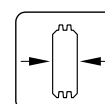

44 mm

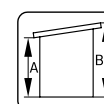

A: 211 cm
B: 244 cm

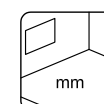

Included
19 mm

OPTIONAL

Roofing felt (underlayer): 3 rolls, SBS roofing material: 3 rolls, roofing nails, EPDM, rain gutters, extension, canopy roof, additional door and window.

under
2,5m

PALMAKO CABIN LISA 19,4 m²

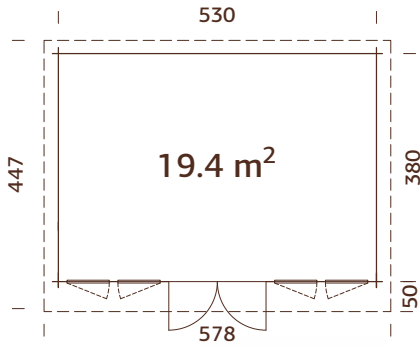

Double glazed.
Includes door
and window bars.



TREATMENT

- Available dipped
- Available painted

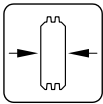

44 mm

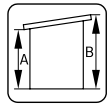

A: 200 cm
B: 234 cm

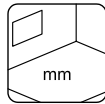

Included
19 mm

MODEL SPECIFICATIONS

Log measurements:

550x400 cm

Volume: 41,9 m³

Door/window type: Summer

Window glass:

Double glass, 3-9-3 mm

Door glass:

Double toughened glass, 4-9-4 mm

Window opening

measurements: 53x104 cm

Door opening

measurements: 144x172 cm

Door sill:

low, covered with stainless steel

Roof boards: 19 mm

Roof area: 25,4 m²

Roof gradient: 5,2°

Gross ground area: 20,1 m²

OPTIONAL

Roofing felt (underlayer): 6 rolls, SBS roofing material: 6 rolls, roofing nails, EPDM, rain gutters, extension, canopy roof, additional door and window.



Lisa 19,4 m²

PALMAKO CABIN LEA 14,2 m²

under
2,5m

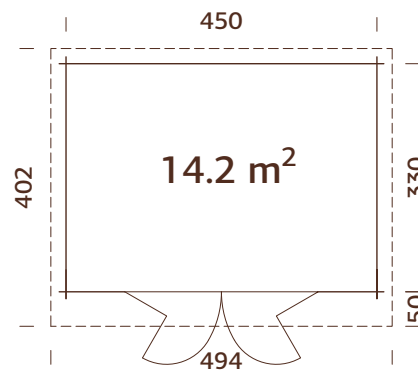

Bifold doors.
Double glazed.

MODEL SPECIFICATIONS

Log measurements:

470x350 cm

Volume: 31,6 m³

Door/window type: Garden+

Door/window glass: Double toughened glass, 4-6-4 mm

Bi-fold door opening

measurements: 263x184 cm

Door sill: low, covered with stainless steel

Roof boards: 19 mm

Roof area: 19,2 m²

Roof gradient: 4,0°

Gross ground area: 14,9 m²

TREATMENT

Available dipped

Available painted

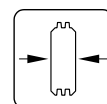

44 mm

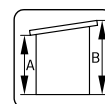

A: 211 cm
B: 244 cm

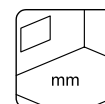

Included
19 mm

OPTIONAL

Roofing felt (underlayer): 3 rolls, SBS roofing material: 3 rolls, roofing nails, EPDM, rain gutters, extension, canopy roof, additional door.

PALMAKO FLAT ROOF CABINS

78-103



Lea 14,2 m² Slide

under
2,5m

PALMAKO CABIN LEA 14,2 m²

SLIDE / SLIDE PLUS



PALMAKO FLAT
ROOF CABINS

78-103

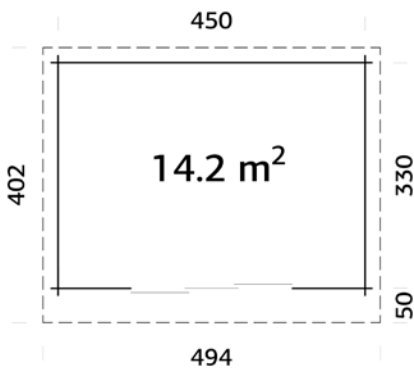

MODEL SPECIFICATIONS

Log measurements: 470x350 cm

Volume: 31,6 m³

**Sliding door opening measurements
(three sheets):** 176x187 cm (Slide),
172x185 cm (Slide Plus)

Roof boards: 19 mm

Roof area: 19,2 m²

Roof gradient: 4,0°

Gross ground area: 14,9 m²

OPTIONAL

Roofing felt (underlayer): 3 rolls, SBS roofing material: 3 rolls, roofing nails, EPDM, rain gutters, extension, canopy roof.

TREATMENT

Available dipped

Available painted

Sliding doors included.

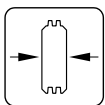

44 mm

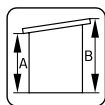

A: 211 cm

B: 244 cm

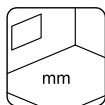

Included

19 mm



Slide

Single glass, toughened, 4 mm



Slide Plus

Double glass, toughened, 4-16-4 mm

PALMAKO CABIN LEA 19,4 m²

under
2,5m

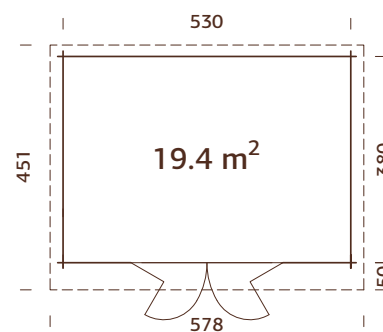

Bifold doors.
Double glazed.

MODEL SPECIFICATIONS

Log measurements:

550x400 cm

Volume: 42,0 m³

Door/window type: Garden+

Door/window glass: Double toughened glass, 4-6-4 mm

Bi-fold door opening

measurements: 263x184 cm

Door sill: low, covered with stainless steel

Roof boards: 19 mm

Roof area: 25,8 m²

Roof gradient: 5,2°

Gross ground area: 20,1 m²

TREATMENT

Available dipped

Available painted

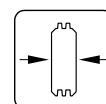

44 mm

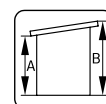

A: 200 cm
B: 249 cm

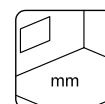

Included
19 mm

OPTIONAL

Roofing felt (underlayer): 6 rolls, SBS roofing material: 6 rolls, roofing nails, EPDM, rain gutters, extension, canopy roof, additional door.



Lea 19,4 m²

under
2,5m

PALMAKO CABIN LEA 19,4 m²

SLIDE / SLIDE PLUS



PALMAKO FLAT
ROOF CABINS

78-103

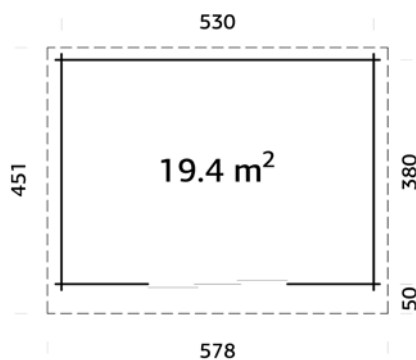

MODEL SPECIFICATIONS

Log measurements: 550x400 cm

Volume: 42,0 m³

**Sliding door opening measurements
(three sheets):** 176x187 cm (Slide),
172x185 cm (Slide Plus)

Roof boards: 19 mm

Roof area: 25,8 m²

Roof gradient: 5,2°

Gross ground area: 20,1 m²

OPTIONAL

Roofing felt (underlayer): 6 rolls, SBS roofing material: 6 rolls, roofing nails, EPDM, rain gutters, extension, canopy roof.

Sliding doors included.

TREATMENT

Available dipped

Available painted



Slide
Single glass, toughened, 4 mm



Slide Plus
Double glass, toughened, 4-16-4 mm

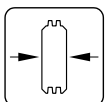

44 mm

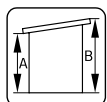

A: 200 cm
B: 249 cm

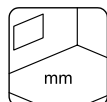

Included
19 mm

PALMAKO CABIN BRET 14,8 m²

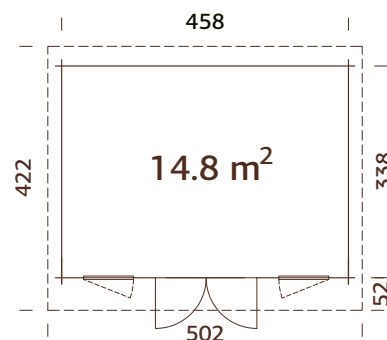

Double glazed.

MODEL SPECIFICATIONS

Log measurements:

478x358 cm

Volume: 34,8 m³

Door/window type: Summer

Door/window glass: Double toughened glass, 4-9-4 mm

Window opening

measurements: 60x159 cm

Door opening

measurements: 144x183 cm

Door sill: low, covered with stainless steel

Roof boards: 19 mm

Roof area: 20,4 m²

Roof gradient: 2,8°

Gross ground area: 15,5 m²

TREATMENT

Available dipped

Available painted

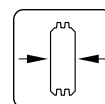

44 mm

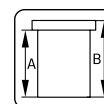

A: 227 cm
B: 254 cm

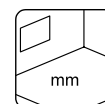

Included
19 mm

OPTIONAL

Roofing felt (underlayer): 5 rolls, SBS roofing material: 5 rolls, roofing nails, EPDM, rain gutters, extension, canopy roof, additional door and window.

PALMAKO CABIN BRET 19,9 m²

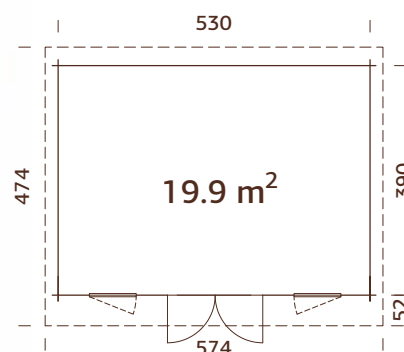

Double glazed.

MODEL SPECIFICATIONS

Log measurements:

550x410 cm

Volume: 46,8 m³

Door/window type: Summer

Door/window glass: Double toughened glass, 4-9-4 mm

Window opening

measurements: 60x159 cm

Door opening

measurements: 44x183 cm

Door sill: low, covered with stainless steel

Roof boards: 19 mm

Roof area: 26,3 m²

Roof gradient: 2,4°

Gross ground area: 20,7 m²

TREATMENT

Available dipped

Available painted

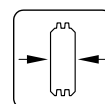

44 mm

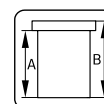

A: 227 cm
B: 254 cm

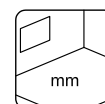

Included
19 mm

OPTIONAL

Roofing felt (underlayer): 6 rolls, SBS roofing material: 6 rolls, roofing nails, EPDM, rain gutters, extension, canopy roof, additional door and window.

PALMAKO CABIN ANDREA 7,5 m²

SLIDE PLUS



under
2,5m

NEW!



Can be built in reverse!

PALMAKO FLAT
ROOF CABINS

78-103

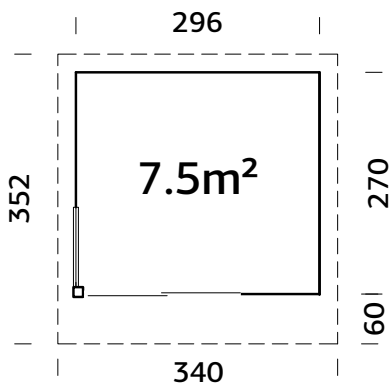

MODEL SPECIFICATIONS

Log measurements: 296x270 cm

Volume: 16,9 m³

Sliding door opening measurements

(two sheets): 88x187 cm (Slide),

85x185 cm (Slide Plus)

Roof boards: 19 mm

Roof area: 11,7 m²

Roof gradient: 4,9°

Gross ground area: 8,0 m²

OPTIONAL

Roofing felt (underlayer): 3 rolls, SBS roofing material: 3 rolls, roofing nails, EPDM, rain gutters.

Modern corner connection.

Sliding doors included.

TREATMENT

Available dipped

Available painted

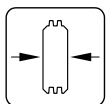

44 mm

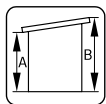

A: 217 cm
B: 249 cm

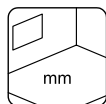

Included
19 mm



Slide Plus

Double glass, toughened, 4-16-4 mm



Aluminium window

Double glass, 4-16-4 mm

PALMAKO CABIN ANDREA 11,2 m²

SLIDE / SLIDE PLUS



Can be built in reverse!

PALMAKO FLAT ROOF CABINS

78-103

MODEL SPECIFICATIONS

Log measurements: 390x300 cm

Volume: 26,7 m³

Sliding door opening measurements

(two sheets): 88x187 cm (Slide),

85x185 cm (Slide Plus)

Sliding door opening measurements

(three sheets): 176x187 cm (Slide),

172x185 cm (Slide Plus)

Roof boards: 19 mm

Roof area: 17,2 m²

Roof gradient: 4,4°

Gross ground area: 11,7 m²

OPTIONAL

Roofing felt (underlayer): 3 rolls, SBS roofing material: 3 rolls, roofing nails, EPDM, rain gutters.

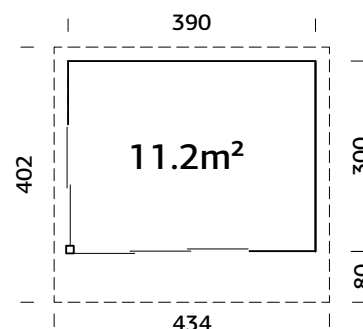

Slide
Single glass, toughened, 4 mm



Slide Plus
Double glass, toughened, 4-16-4 mm

Modern corner connection.
Sliding doors included.
Strong purlins from laminated wood

TREATMENT

Available dipped

Available painted

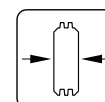

44 mm

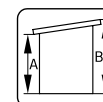

A: 228 cm
B: 264 cm

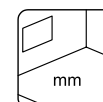

Included
19 mm



PALMAKO CABIN ANDREA 11,2+7,9 m²

SLIDE / SLIDE PLUS



Can be built in reverse!

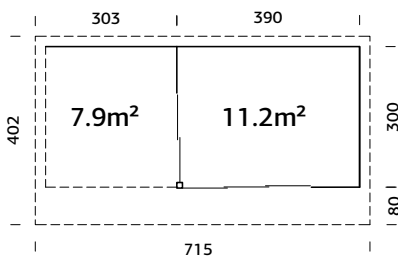

MODEL SPECIFICATIONS

Log measurements: 693x300 cm

Volume: 26,7+20,2 m³

Sliding door opening measurements

(two sheets): 88x187 cm (Slide),

85x185 cm (Slide Plus)

Sliding door opening measurements

(three sheets): 176x187 cm (Slide),

172x185 cm (Slide Plus)

Roof boards: 19 mm

Roof area: 29,5 m²

Roof gradient: 4,4°

Gross ground area: 20,0 m²

OPTIONAL

Roofing felt (underlayer): 5 rolls, SBS roofing material: 5 rolls, roofing nails, EPDM, rain gutters.

- Modern corner connection.
- Sliding doors included.
- Strong purlins from laminated wood
- Strong posts from laminated wood

TREATMENT

Available dipped

Available painted

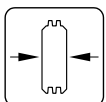

44 mm

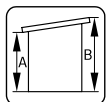

A: 228 cm

B: 264 cm

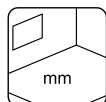

Included

19 mm



Slide
Single glass, toughened, 4 mm



Slide Plus
Double glass, toughened, 4-16-4 mm

PALMAKO CABIN ANDREA 17,1 m²

SLIDE / SLIDE PLUS



Can be built in reverse!

MODEL SPECIFICATIONS

Log measurements: 595x300 cm

Volume: 41,0 m³

Fixed window measurements: 83x160 cm

Sliding door opening measurements

(two sheets): 88x187 cm (Slide),

85x185 cm (Slide Plus)

Sliding door opening measurements

(three sheets): 176x187 cm (Slide),

172x185 cm (Slide Plus)

Roof boards: 19 mm

Roof area: 25,4 m²

Roof gradient: 4,4°

Gross ground area: 17,9 m²

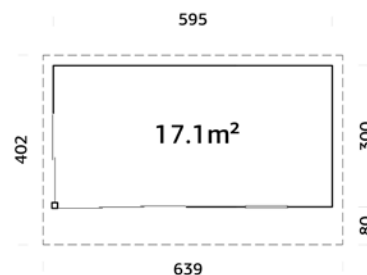

OPTIONAL

Roofing felt (underlayer): 5 rolls, SBS roofing material: 5 rolls, roofing nails, EPDM, rain gutters, additional window.

Modern corner connection.

Sliding doors included.

Strong purlins from laminated wood



Slide
Single glass, toughened, 4 mm



Slide Plus
Double glass, toughened, 4-16-4 mm

TREATMENT

Available dipped

Available painted

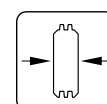

44 mm

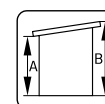

A: 228 cm
B: 264 cm

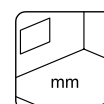

Included
19 mm

PALMAKO CABIN ANDREA 17,1+7,9 m²

SLIDE / SLIDE PLUS



Can be built in reverse!

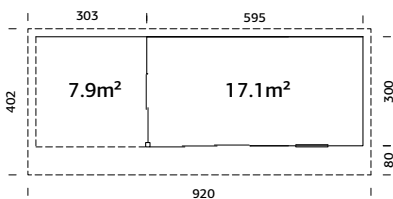

MODEL SPECIFICATIONS

Log measurements: 898x300 cm

Volume: 41,0+20,2 m³

Fixed window measurements: 83x160 cm

Sliding door opening measurements

(two sheets): 88x187 cm (Slide),
85x185 cm (Slide Plus)

Sliding door opening measurements

(three sheets): 176x187 cm (Slide),
172x185 cm (Slide Plus)

Roof boards: 19 mm

Roof area: 37,7 m²

Roof gradient: 4,4°

Gross ground area: 26,2 m²

OPTIONAL

Roofing felt (underlayer): 5 rolls, SBS roofing material: 5 rolls, roofing nails, EPDM, rain gutters, additional window.

Modern corner connection.

Sliding doors included.

Strong purlins from laminated wood

Strong posts from laminated wood

TREATMENT

Available dipped

Available painted

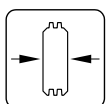

44 mm

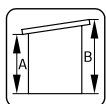

A: 228 cm

B: 264 cm

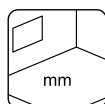

Included

19 mm



Slide

Single glass, toughened, 4 mm



Slide Plus

Double glass, toughened, 4-16-4 mm

PALMAKO CABIN HEIDI 11,7 m²

under
2,5m

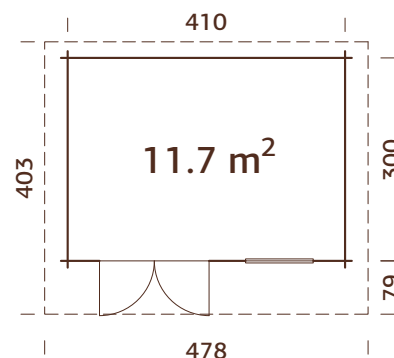

Double glazed.

MODEL SPECIFICATIONS

Log measurements:

430x320 cm

Volume: 26,7 m³

Door/window type: Summer

Door/window glass: Double toughened glass, 4-9-4 mm

Fixed window,

measurements: 90x168 cm

Door opening

measurements: 144x183 cm

Door sill: low, covered with stainless steel

Roof boards: 19 mm

Roof area: 18,6 m²

Roof gradient: 2,2°

Gross ground area: 12,3 m²

TREATMENT

Available dipped

Available painted

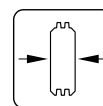

44 mm

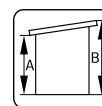

A: 222 cm
B: 244 cm

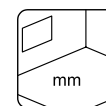

Included
19 mm

OPTIONAL

Roofing felt (underlayer): 3 rolls, SBS roofing material: 3 rolls, roofing nails, EPDM, rain gutters, additional door and window.

PALMAKO CABIN HEIDI 19,7 m²

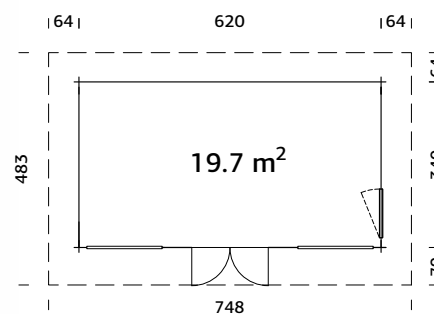

Double glazed.

MODEL SPECIFICATIONS

Log measurements:

640x360 cm

Volume: 49,5 m³

Door/window type: Summer

Door/window glass: Double toughened glass, 4-9-4 mm

Window opening

measurements: 77x191 cm

Fixed window,

measurements: 138x188 cm

Door opening

measurements: 141x199 cm

Door sill: low,

covered with stainless steel

Roof boards: 19 mm

Roof area: 36,5 m²

Roof gradient: 9,2°

Gross ground area: 21,1 m²

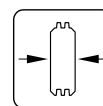

70 mm

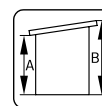

A: 236 cm
B: 314 cm

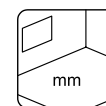

Included
19 mm

OPTIONAL

Roofing felt (underlayer): 6 rolls, SBS roofing material: 6 rolls, roofing nails, EPDM, rain gutters, additional door and window.

PALMAKO CABIN HEIDI 22,5 m²

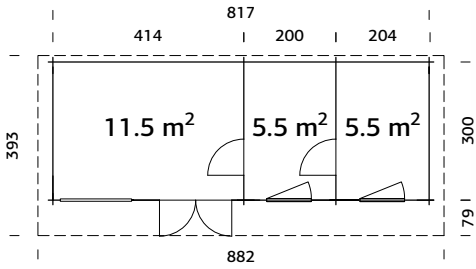

Double glazed.

MODEL SPECIFICATIONS

Log measurements:

837x320 cm

Volume: 59,5 m³

Door/window type: Summer

Door/window glass: Double toughened glass, 4-9-4 mm

Window opening

measurements: 77x191 cm

Fixed window

measurements: 138x188 cm

Door opening

measurements: 67x192 cm, 141x199 cm

Door sill: low, covered with stainless steel

Roof boards: 19 mm

Roof area: 34,2 m²

Roof gradient: 9,2°

Gross ground area: 24,5 m²

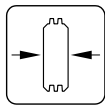

70 mm

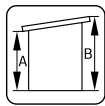

A: 243 cm

B: 302 cm

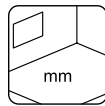

Included

28 mm

OPTIONAL

Roofing felt (underlayer): 5 rolls, SBS roofing material: 5 rolls, roofing nails, rain gutters, additional door and window.

PALMAKO CABIN HEIDI 22,8 m²

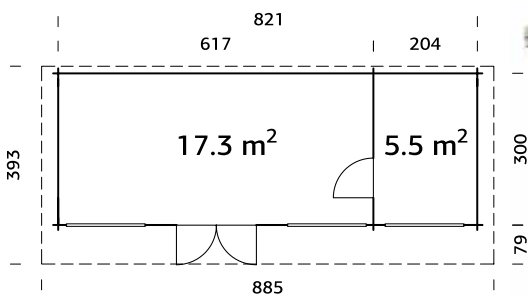

Double glazed.

MODEL SPECIFICATIONS

Log measurements:

840x320 cm

Volume: 59,2 m³

Door/window type: Summer

Door/window glass: Double toughened glass, 4-9-4 mm

Fixed window

measurements:

138x188 cm, 138x36 cm

Door opening

measurements: 67x192 cm, 141x199 cm

Door sill: low, covered with stainless steel

Roof boards: 19 mm

Roof area: 34,6 m²

Roof gradient: 9,0°

Gross ground area: 24,6 m²

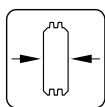

70 mm

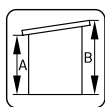

A: 236 cm

B: 270 cm

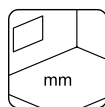

Included

28 mm

OPTIONAL

Roofing felt (underlayer): 6 rolls, SBS roofing material: 6 rolls, roofing nails, rain gutters, additional door and window.

OPTIONAL PRODUCTS

SEE OPTIONAL PRODUCTS, PAGES 344-368

House	Art. No.	Floor ¹	Roofing felt, rolls	SBS roofing material, rolls	Roofing nails, 1 kg	EPDM	Rain gutters	Extension	Canopy roof
Alice 4.7 m ²	111242	109456	107210, 1 rolls	107214, 1 rolls	107930	111847	106627		103168
Alice 6.1 m ²	111244	109522	107210, 2 rolls	107214, 2 rolls	107930	111847	106627		103168
Alice 9.0 m ²	111246	109518	107210, 2 rolls	107214, 2 rolls	107930	2 x 111847	106627		103168
Alice 11.0 m ²	111248	109520	107210, 3 rolls	107214, 3 rolls	107930	2 x 111847	106627		103168
Ella 6.9 m ²	101453	102967	107210, 2 rolls	107214, 2 rolls	107930	111847	106626		
Ella 8.7 m ²	101543	102994	107210, 3 rolls	107214, 3 rolls	107930	111847	106627		
Ella 6.9+8.2 m ²	101595	102967	107210, 5 rolls	107214, 5 rolls	107930	2 x 111847	106628		
Ella 6.9+10.0 m ²	101607	102967	107210, 5 rolls	107214, 5 rolls	107930	2 x 111847	106626 + 106627		
Ella 8.7+8.2 m ²	101611	102994	107210, 5 rolls	107214, 5 rolls	107930	2 x 111847	106626 + 106627		
Ella 8.7+10.0 m ²	101623	102994	107210, 5 rolls	107214, 5 rolls	107930	3 x 111847	106626 + 106627		
Ella 13.1 m ²	108218	108279	107210, 3 rolls	107214, 3 rolls	107930	2 x 111847	107375		
Ella 13.1+3.9 m ²	108222	108279	107210, 5 rolls	107214, 5 rolls	107930	2 x 111847	106626 + 106627		
Bret 14.8 m ²	102205	107210, 5 rolls	107210, 5 rolls	107214, 5 rolls	107930	2 x 111847	107375	102801	103168
Bret 19.9 m ²	102218	107210, 6 rolls	107210, 6 rolls	107214, 6 rolls	107930	2 x 111847	106628	102801	103168
Lisa 11.5 m ²	102281	107210, 3 rolls	107210, 3 rolls	107214, 3 rolls	107930	2 x 111847	107375	102801	103168
Lisa 14.2 m ²	102197	107210, 3 rolls	107210, 3 rolls	107214, 3 rolls	107930	2 x 111847	107375	102801	103168
Lisa 19.4 m ²	101749	107210, 6 rolls	107210, 6 rolls	107214, 6 rolls	107930	3 x 111847	106628	102801	103168

¹ Includes treated joists. The article number is indicated to untreated items, for treated items ask our sales team.

OPTIONAL PRODUCTS

SEE OPTIONAL PRODUCTS, PAGES 344-368



House	Art. No.	Floor ¹	Roofing felt, rolls	SBS roofing material, rolls	Roofing nails 1 kg	EPDM	Rain gutters	Extension	Canopy roof
Lea 14,2 m ²	101728		107210, 3 rolls	107214, 3 rolls	107930	2 x 111847	107375	102801	103168
Lea 19,4 m ²	101736		107210, 6 rolls	107214, 6 rolls	107930	3 x 111847	106628	102801	103168
Lea 14,2 m ² Slide	111187		107210, 3 rolls	107214, 3 rolls	107930	2 x 111847	107375	102801	103168
Lea 14,2 m ² Slide Plus	111191		107210, 3 rolls	107214, 3 rolls	107930	2 x 111847	107375	102801	103168
Lea 19,4 m ² Slide	111195		107210, 6 rolls	107214, 6 rolls	107930	3 x 111847	106628	102801	103168
Lea 19,4 m ² Slide Plus	111199		107210, 6 rolls	107214, 6 rolls	107930	3 x 111847	106628	102801	103168
Andrea 7,5 m ² Slide Plus	119316		107210, 3 rolls	107214, 3 rolls	107930	2 x 111847	106627		
Andrea 11,2 m ² Slide	111215		107210, 3 rolls	107214, 3 rolls	107930	2 x 111847	107075		
Andrea 11,2 m ² Slide Plus	111223		107210, 3 rolls	107214, 3 rolls	107930	2 x 111847	107075		
Andrea 11,2+7,9 m ² Slide	111204		107210, 5 rolls	107214, 5 rolls	107930	3 x 111847	2 x 106627		
Andrea 11,2+7,9 m ² Slide Plus	111231		107210, 5 rolls	107214, 5 rolls	107930	3 x 111847	2 x 106627		
Andrea 17,1 m ² Slide	111211		107210, 5 rolls	107214, 5 rolls	107930	2 x 111847	106626+106627		
Andrea 17,1 m ² Slide Plus	111227		107210, 5 rolls	107214, 5 rolls	107930	2 x 111847	106626+106627		
Andrea 17,1+7,9 m ² Slide	111203		107210, 5 rolls	107214, 5 rolls	107930	3 x 111847	106626+106627		
Andrea 17,12+7,9 m ² Slide Plus	111235		107210, 5 rolls	107214, 5 rolls	107930	3 x 111847	106626+106627		
Heidi 11,7 m ²	106355		107210, 3 rolls	107214, 3 rolls	107930	2 x 111847	107375		
Heidi 19,7 m ²	106370		107210, 6 rolls	107214, 6 rolls	107930	3 x 111847	2 x 106627		
Heidi 22,5 m ²	110077		107210, 5 rolls	107214, 5 rolls	107930	3 x 111847	106628+106626		
Heidi 22,8 m ²	106381		107210, 6 rolls	107214, 6 rolls	107930	3 x 111847	106628+106626		

¹ includes treated joists.
The article number is indicated to untreated items, for treated items ask our sales team.



Cecilia 32,8 m² Slide Plus

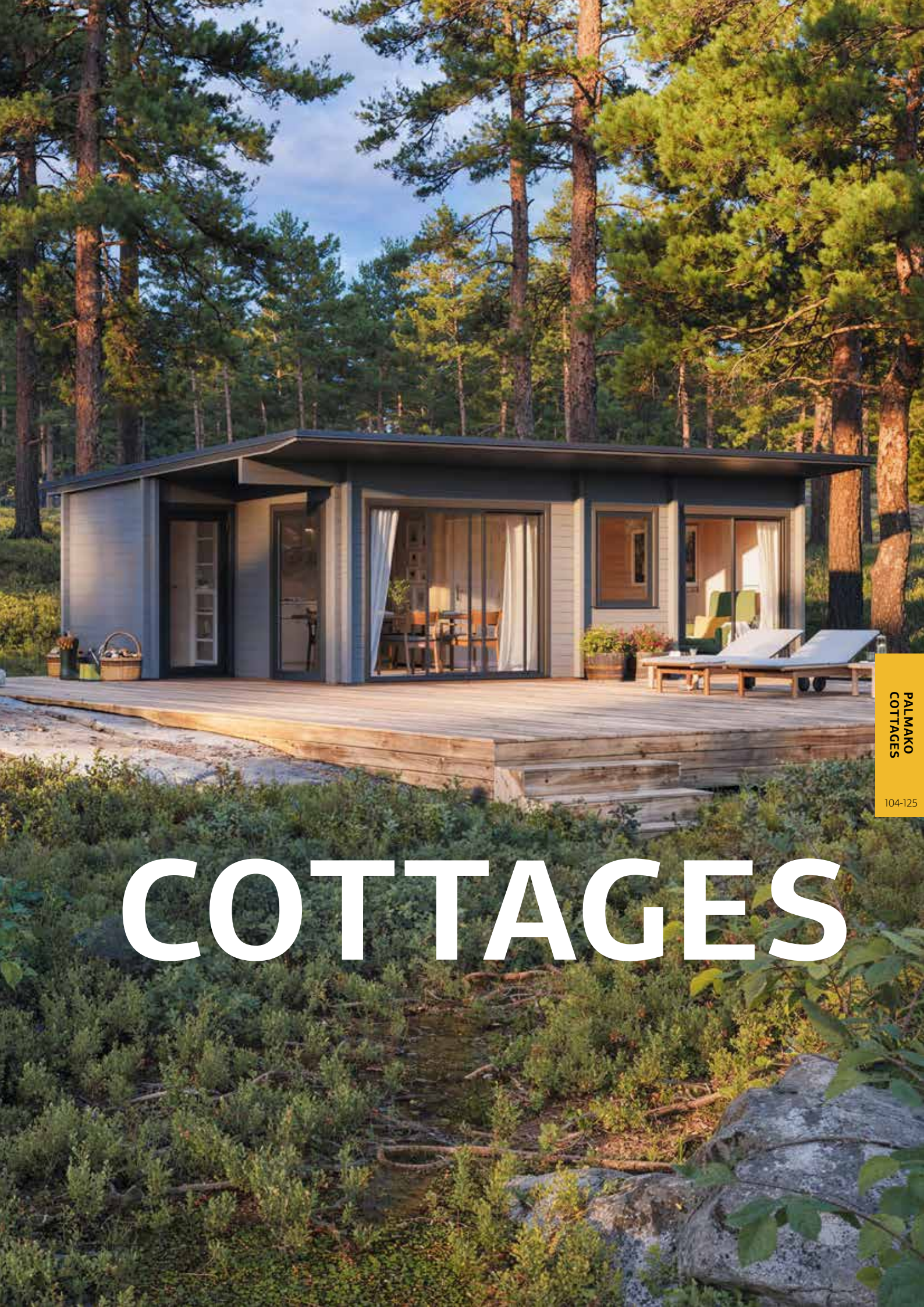

COTTAGES

COTTAGES



PALMAKO COTTAGE
KENDRA 18,4 m²



PALMAKO COTTAGE
EMILY 39,2 m²



PALMAKO COTTAGE
EMILY 40,1+5,2 m²



PALMAKO COTTAGE
AGNETA 18,8+12,5 m²



PALMAKO COTTAGE
AGNETA 18,8+28,8 m²



PALMAKO COTTAGE
ANNA 26,8 m²



PALMAKO COTTAGE
ANNA 26,8+1,9 m²



PALMAKO COTTAGE
SANDRA 21,5+3,7 m²



PALMAKO COTTAGE
SANDRA 25,6+11,1 m²



PALMAKO COTTAGE
SANDRA 29,9 m²



PALMAKO COTTAGE
CECILIA 14,6 m²
SLIDE PLUS



PALMAKO COTTAGE
CECILIA 22,3 m²
SLIDE PLUS



PALMAKO COTTAGE
CECILIA 27,7 m²
SLIDE PLUS



PALMAKO COTTAGE
CECILIA 30,7 m²
SLIDE PLUS



PALMAKO COTTAGE
CECILIA 32,8 m²
SLIDE PLUS

PALMAKO COTTAGE KENDRA 18,4 m²



MODEL SPECIFICATIONS

Log measurements: 419x519 cm

Volume: 66,2 m³

Door/window type: Summer

Window glass:

Double glass, 3-9-3 mm

Door glass: Double toughened glass, 4-9-4 mm

Door sill: low, covered with stainless steel

Roof boards: 19 mm

Roof area: 34,7 m²

Roof gradient: 36,4°

Gross ground area: 19,9 m²

Ground floor: 15,4+3,0 m²

First floor: 17,6 m²

OPTIONAL

Roofing felt (underlayer): 9 rolls, SBS roofing material: 9 rolls, shingles 13 packs, roofing nails, additional door and window.

Double glazed.

Strong purlins from laminated wood.

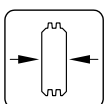

70 mm

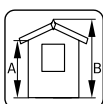

A: 283 cm
B: 432 cm

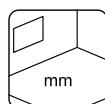

Included
19 mm

PALMAKO COTTAGE EMILY 39,2 m²



MODEL SPECIFICATIONS

Log measurements: 660x780 cm

Volume: 102,2 m³

Door/window type: Summer

Door/window glass:

Double glass, 3-9-3 mm

Door sill: low, covered with stainless steel

Roof boards: 19 mm

Roof area: 53,9 m²

Roof gradient: 15,8°

Gross ground area: 42,0 m²

OPTIONAL

Roofing felt (underlayer): 10 rolls, SBS roofing material: 10 rolls, shingles: 21 packs, roofing nails, additional door and window.

Double glazed.

Strong purlins from laminated wood.

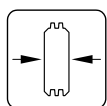

70 mm

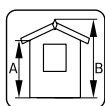

A: 230 cm
B: 310 cm

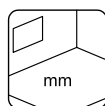

Included
28 mm

PALMAKO COTTAGE EMILY 40,1+5,2 m²



MODEL SPECIFICATIONS

Log measurements: 590x570 cm

Volume: 79,8 m³

Terrace: 339x153 cm

Door/window type: Summer

Door/window glass:

Double glass, 3-9-3 mm

Door sill: low, covered with stainless steel

Roof boards: 19 mm

Roof area: 41,9 m²

Roof gradient: 24,8°

Gross ground area (terrace included): 31,4 m²

Ground floor: 23,7+5,2 m²

First floor: 16,4 m²

OPTIONAL

Roofing felt (underlayer): 9 rolls, SBS roofing material: 9 rolls, shingles: 16 packs, roofing nails, additional door and window.

Double glazed.

Strong purlins from laminated wood.

Terrace boards are treated.

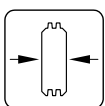

70 mm

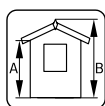

A: 256 cm
B: 395 cm

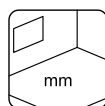

Included
28 mm

PALMAKO COTTAGE AGNETA 18,8+12,5 m²

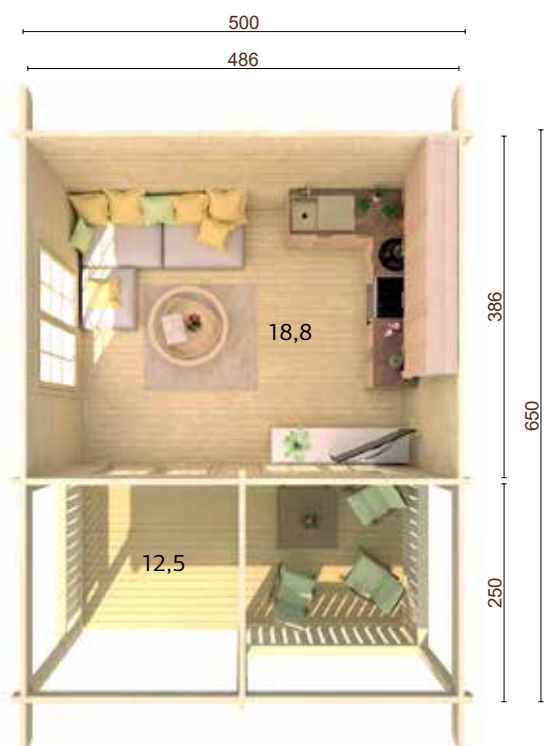

MODEL SPECIFICATIONS

Log measurements (house):

520x420 cm

Log measurements (house with terrace):

520x650 cm

Volume: 58,1 m³

Terrace: 250x500 cm

Door/window type: Summer

Door/window glass:

Double toughened glass,

4-9-4 mm

OPTIONAL

Roofing felt (underlayer): 7 rolls, SBS roofing material: 7 rolls, shingles: 18 packs,

roofing nails, additional door and window.

Door sill: low, covered with

stainless steel

Roof boards: 19 mm

Roof area: 47,3 m²

Roof gradient: 18,0°

Gross ground area (terrace included): 32,3 m²

Double glazed.

Can be built in reverse!

Terrace boards are treated.

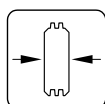

70 mm

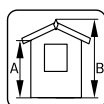

A: 250 cm

B: 357 cm

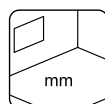

Included

28 mm

PALMAKO COTTAGE AGNETA 18,8+28,8 m²

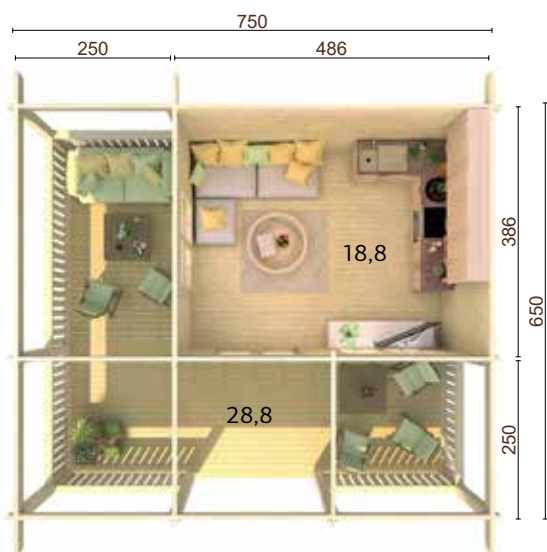

MODEL SPECIFICATIONS

Log measurements (house):

520x420 cm

Log measurements (house with terrace):

750x650 cm

Volume: 63,8 m³

Terrace: 250x750 cm, 250x650 cm

Door/window type: Summer

Door/window glass:

Double toughened glass,
4-9-4 mm

Door sill: low, covered with
stainless steel

Roof boards: 19 mm

Roof area: 67,2 m²

Roof gradient: 18,0°

Gross ground area
(terrace included): 48,1 m²

OPTIONAL

Roofing felt (underlayer): 11 rolls, SBS roofing material: 11 rolls, shingles: 24 packs, roofing nails, additional door and window.

Double glazed.

Terrace boards are treated.

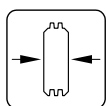

70 mm

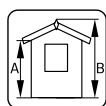

A: 250 cm
B: 400 cm

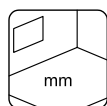

Included
28 mm

PALMAKO COTTAGE ANNA 26,8 m²

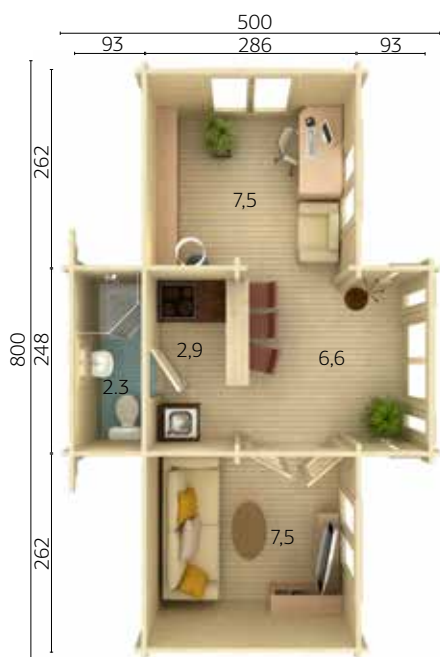

MODEL SPECIFICATIONS

Log measurements: 820x520 cm

Volume: 81,9 m³

Door/window type: Summer

Door/window glass: Double toughened glass, 4-9-4 mm

Door sill: low, covered with stainless steel

Roof boards: 19 mm

Roof area: 46,7 m²

Roof gradient: 25,3°

Gross ground area : 29,2 m²

OPTIONAL

Roofing felt (underlayer): 7 rolls, SBS roofing material: 7 rolls, shingles: 18 packs, roofing nails, additional door and window.

Double glazed.

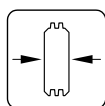

70 mm

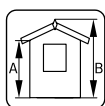

A: 257 cm
B: 330 cm

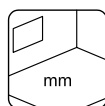

Included
28 mm

PALMAKO COTTAGE ANNA 26,8+1,9 m²

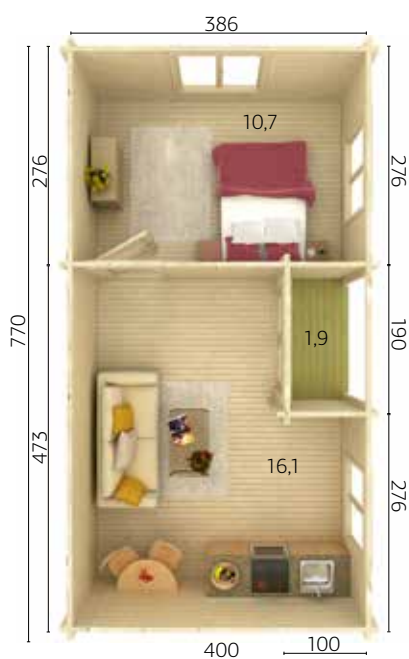

MODEL SPECIFICATIONS

Log measurements: 790x420 cm

Volume: 75,6 m³

Terrace: 190x100 cm

Door/window type: Summer

Door/window glass: Double toughened glass, 4-9-4 mm

Door sill: low, covered with stainless steel

Roof boards: 19 mm

Roof area: 39,7 m²

Roof gradient: 17,5°

Gross ground area: 30,8 m²

OPTIONAL

Roofing felt (underlayer): 7 rolls, SBS roofing material: 7 rolls, shingles: 16 packs, roofing nails, additional door and window.

Double glazed.

Terrace boards are treated.

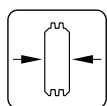

70 mm

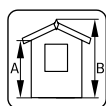

A: 229 cm
B: 297 cm

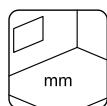

Included
28 mm

PALMAKO COTTAGE SANDRA 21,5+3,7 m²

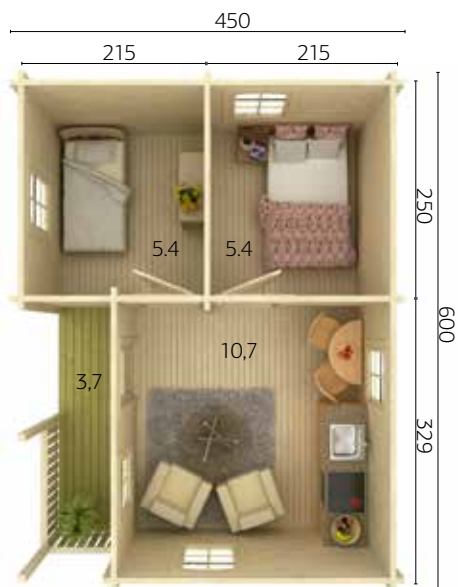

MODEL SPECIFICATIONS

Log measurements: 620x470 cm

Volume: 59,7 m³

Terrace: 329x104 cm

Door/window type: Summer

Door/window glass:

Double glass, 3-9-3 mm

Door sill: low, covered with stainless steel

Roof boards: 19 mm

Roof area: 36,0 m²

Roof gradient: 20,4°

Gross ground area (terrace included): 27,0 m²

OPTIONAL

Roofing felt (underlayer): 7 rolls, SBS roofing material: 7 rolls, shingles: 14 packs, roofing nails, additional door and window.

Double glazed.

Strong purlins from laminated wood.

Terrace boards are treated.

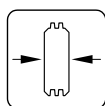

70 mm

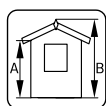

A: 230 cm
B: 320 cm

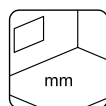

Included
28 mm

PALMAKO COTTAGE SANDRA 25,6+11,1 m²



MODEL SPECIFICATIONS

Log measurements:

791x370(520) cm

Volume: 106,2 m³

Terrace: 771x146 cm

Door/window type: Summer

Door/window glass:

Double glass, 3-9-3 mm

Door sill: low, covered with stainless steel

Roof boards: 19 mm

Roof area: 48,5 m²

Roof gradient: 19,2°

Gross ground area

(terrace included): 38,6 m²

OPTIONAL

Roofing felt (underlayer): 9 rolls, SBS roofing material: 9 rolls, shingles: 18 packs, roofing nails, additional door and window.

Double glazed.

Terrace boards are treated.

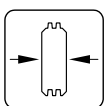

44 mm

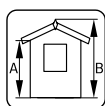

A: 239 cm
B: 335 cm

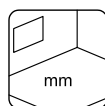

Included
19 mm

PALMAKO COTTAGE SANDRA 29,9 m²



MODEL SPECIFICATIONS

Log measurements: 605x410 cm

Volume: 65,6 m³

Door/window type: Summer

Door/window glass:

Double glass, 3-9-3 mm

Door sill: low, covered with

stainless steel

Roof boards: 19 mm

Roof area: 37,7 m²

Roof gradient: 32,1°

Gross ground area: 22,8 m²

Ground floor: 21,7 m²

First floor: 8,2 m²

OPTIONAL

Roofing felt (underlayer): 8 rolls, SBS roofing material: 8 rolls, shingles: 15 packs, roofing nails, additional door and window.

Double glazed.

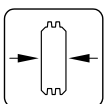

44 mm

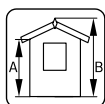

A: 239 cm
B: 370 cm

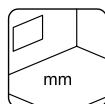

Included
19 mm

PALMAKO COTTAGE CECILIA 14,2 m²

SLIDE PLUS

NEW!



Can be built in reverse!



MODEL SPECIFICATIONS

Log measurements: 520x334 cm

Volume: 36,0 m³

Door/window type: Summer

Door glass:

Double toughened, 4-16-4 mm

Window glass:

Double glass, 4-16-4 mm

Roof boards: 19 mm

Roof area: 29,3 m²

Roof gradient: 3,0°

Gross ground area: 15,7 m²

OPTIONAL

Roofing felt (underlayer): 5 rolls, SBS roofing material: 5 rolls, roofing nails, EPDM, rain gutters, additional door and window.

Aluminium doors and windows.

Double glazed.

Sliding doors included.

Metal roof edge included.

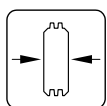

70 mm

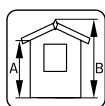

A: 239 cm
B: 279 cm

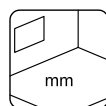

Included
28 mm



Slide Plus
Double glass, toughened,
4-16-4 mm



Aluminium window
Double glass, 4-16-4 mm



Aluminium door
Double glass, toughened,
4-16-4 mm



Cecilia 21,8 m² Slide Plus



Cecilia 21,8 m² Slide Plus interior view

PALMAKO COTTAGE CECILIA 21,8 m²

SLIDE PLUS

NEW!



Can be built in reverse!



MODEL SPECIFICATIONS

Log measurements: 780x334 cm

Volume: 55,2 m³

Door/window type: Summer

Door glass:

Double toughened, 4-16-4 mm

Window glass:

Double glass, 4-16-4 mm

Roof boards: 19 mm

Roof area: 46,7 m²

Roof gradient: 3,0°

Gross ground area: 23,9 m²

OPTIONAL

Roofing felt (underlayer): 6 rolls, SBS roofing material: 6 rolls, roofing nails, EPDM, rain gutters, additional door and window.

Aluminium doors and windows.
Double glazed.
Sliding doors included.
Metal roof edge included.

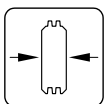

70 mm

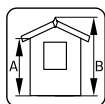

A: 239 cm
B: 278 cm

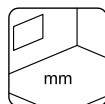

Included
28 mm



Slide Plus
Double glass, toughened,
4-16-4 mm



Aluminium window
Double glass, 4-16-4 mm



Aluminium door
Double glass, toughened,
4-16-4 mm

PALMAKO COTTAGE CECILIA 27,2 m²

NEW!

SLIDE PLUS



Can be built in reverse!



MODEL SPECIFICATIONS

Log measurements:

560x560cm

Volume: 72,4 m³

Door/window type: Summer

Door glass:

Double toughened, 4-16-4 mm

Window glass:

Double glass, 4-16-4 mm

Roof boards: 19 mm

Roof area: 48,5 m²

Roof gradient: 3,0°

Gross ground area: 29,2 m²

OPTIONAL

Roofing felt (underlayer): 7 rolls, SBS roofing material: 7 rolls, roofing nails, EPDM, rain gutters, additional door and window.

Aluminium doors and windows.

Double glazed.

Sliding doors included.

Metal roof edge included.

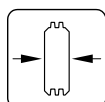

70 mm

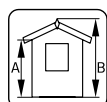

A: 240 cm
B: 290 cm

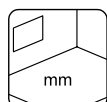

Included
28 mm



Slide Plus
Double glass, toughened,
4-16-4 mm



Aluminium window
Double glass, 4-16-4 mm



Aluminium door
Double glass, toughened,
4-16-4 mm

PALMAKO COTTAGE CECILIA 30,0 m²

SLIDE PLUS

NEW!

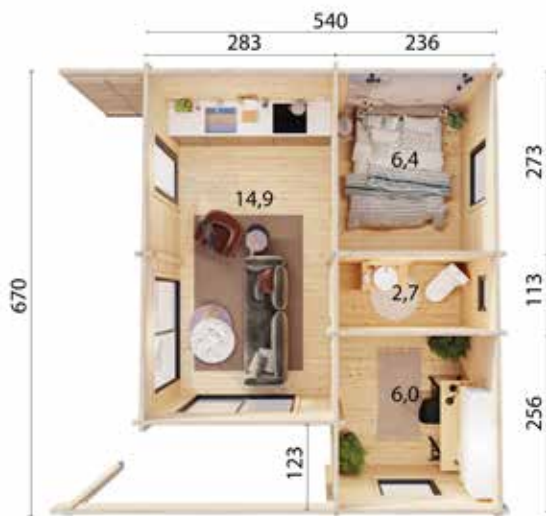

Can be built in reverse!

**MODEL SPECIFICATIONS****Log measurements:** 560x690 cm**Volume:** 78,8 m³**Door/window type:** Summer**Door glass:**

Double toughened, 4-16-4 mm

Window glass:

Double glass, 4-16-4 mm

Roof boards: 19 mm**Roof area:** 55,4 m²**Roof gradient:** 3,0°**Gross ground area:** 32,4 m²**OPTIONAL**

Roofing felt (underlayer): 7 rolls, SBS roofing material: 7 rolls, roofing nails, EPDM, rain gutters, additional door and window.

Aluminium doors and windows.

Double glazed.

Sliding doors included.

Metal roof edge included.

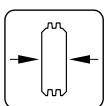

70 mm

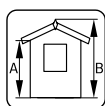
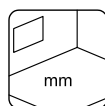
A: 240 cm
B: 295 cm

Included
28 mm

Slide Plus
 Double glass, toughened,
 4-16-4 mm

Aluminium window
 Double glass, 4-16-4 mm

Aluminium door
 Double glass, toughened,
 4-16-4 mm

PALMAKO COTTAGE CECILIA 32,0 m²

SLIDE PLUS

NEW!



Can be built in reverse!

MODEL SPECIFICATIONS

Log measurements: 910x440 cm

Volume: 81,3 m³

Door/window type: Summer

Door glass:
Double toughened, 4-16-4 mm

Window glass:
Double glass, 4-16-4 mm

Roof boards: 19 mm

Roof area: 52,3 m²

Roof gradient: 3,0°

Gross ground area: 34,6 m²



OPTIONAL

Roofing felt (underlayer): 8 rolls, SBS roofing material: 8 rolls, roofing nails, EPDM, rain gutters, additional door and window.

Aluminium doors and windows.
Double glazed.
Sliding doors included.
Metal roof edge included.

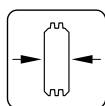

70 mm

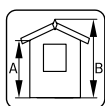

A: 237 cm
B: 290 cm

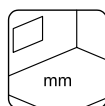

Included
28 mm



Slide Plus
Double glass, toughened,
4-16-4 mm



Aluminium window
Double glass, 4-16-4 mm



Aluminium door
Double glass, toughened,
4-16-4 mm

WE PRODUCE COTTAGES OF YOUR DREAMS

We offer houses with wall thicknesses of 44 mm and 70 mm solid timber, as well as 88 mm, 114 mm and 134 mm laminated timber.

This catalogue includes only some of the models and ideas available for weekend houses – with the help of our architects and bespoke design service we are also able to offer buildings made to your own specific design and requirements.

The 4-side views and ground plans will be supplied when necessary for acquiring a building permit. We can offer you the complete set of wooden details needed for the construction of the house like doors-windows, stairs, cladding for the walls etc. With every house we supply detailed specifications and blueprints for installing the house. All parts have been marked to simplify construction. Please ask for further details.

Individual modifications for all these cottage models in this catalogue are possible! We can also offer these houses with premium quality doors and windows (starting from 70 mm log thickness).

We hope you will take contact with us if you have a dream cottage vision in your head. Together we will definitely find the best solution bringing it to reality.

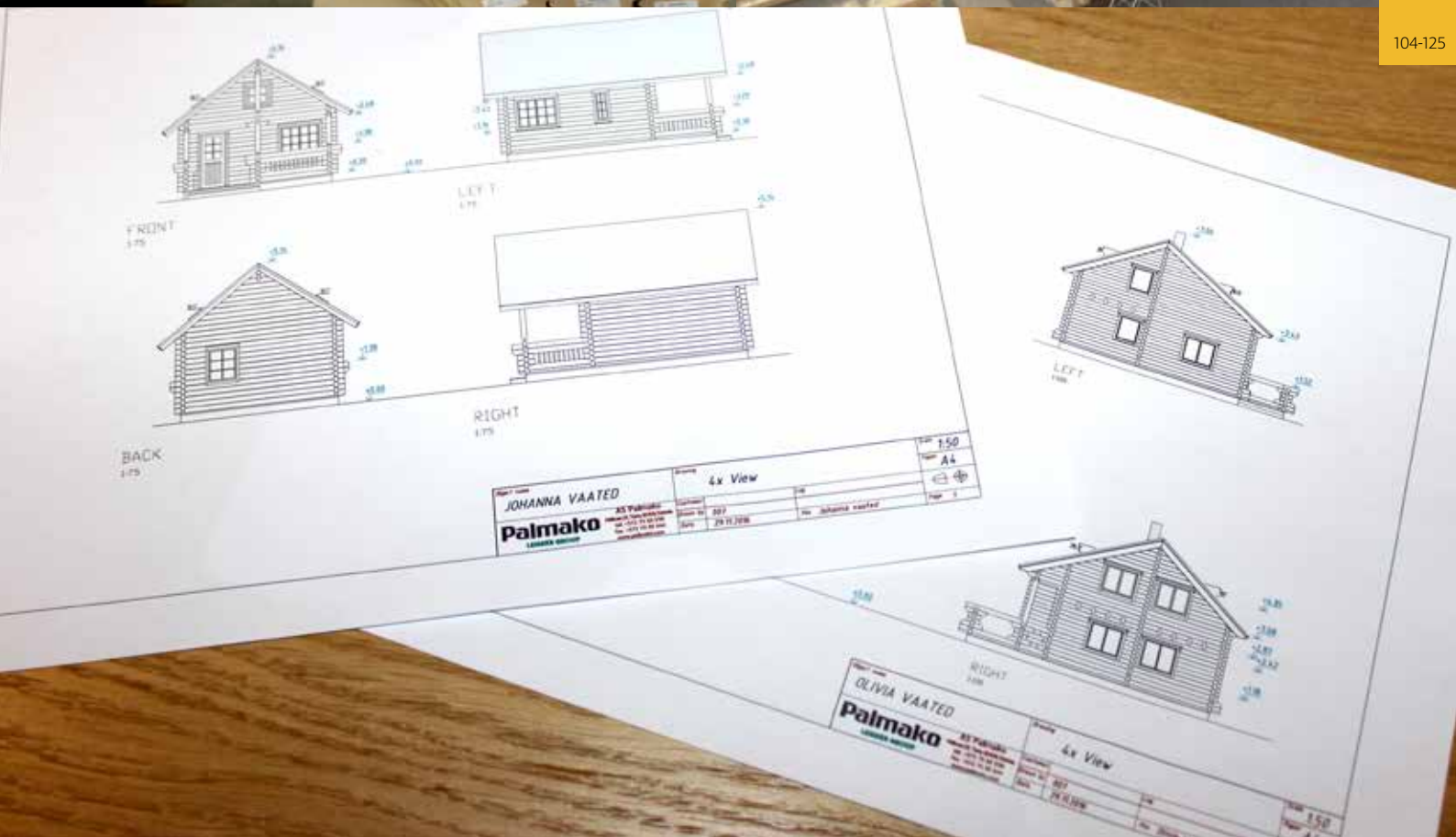

OPTIONAL PRODUCTS

SEE OPTIONAL PRODUCTS, PAGES 344-368

House	Art. No.	Roofing felt, rolls	SBS roofing material, rolls	Shingles, packs	EPDM	Rain gutters	Roofing nails, 1 kg
Kendra 18,4 m ²	109494	107210 9 rolls	107214 9 rolls	13 packs			2 x 107930
Emily 39,2 m ²	106569	107210 10 rolls	107214 10 rolls	21 packs			3 x 107930
Emily 40,1+5,2 m ²	106566	107210 9 rolls	107214 9 rolls	16 packs			2 x 107930
Agneta 18,8+12,5 m ²	106522	107210 7 rolls	107214 7 rolls	18 packs			2 x 107930
Agneta 18,8+28,8 m ²	106526	107210 11 rolls	107214 11 rolls	24 packs			3 x 107930
Anna 26,8 m ²	106568	107210 7 rolls	107214 7 rolls	18 packs			2 x 107930
Anna 26,8+1,9 m ²	106599	107210 7 rolls	107214 7 rolls	16 packs			2 x 107930
Sandra 21,5+3,7 m ²	106567	107210 7 rolls	107214 7 rolls	14 packs			2 x 107930
Sandra 25,6+11,1 m ²	106210	107210 9 rolls	107214 9 rolls	18 packs			2 x 107930
Sandra 29,9 m ²	106214	107210 8 rolls	107214 8 rolls	15 packs			2 x 107930
Cecilia 14,2 m ² Slide Plus	120010	107210, 5 rolls	107214, 5 rolls ¹		3 x 111847	106626 + 106627	107950
Cecilia 21,8 m ² Slide Plus	120009	107210, 6 rolls	107214, 6 rolls		5 x 111847	106626, 2 x 106627	107950
Cecilia 27,2 m ² Slide Plus	120008	107210, 7 rolls	107214, 7 rolls		5 x 111847	106626 + 106627	107950
Cecilia 30,0 m ² Slide Plus	120007	107210, 7 rolls	107214, 7 rolls		5 x 111847	106626 + 106627	107950
Cecilia 32,0 m ² Slide Plus	120006	107210, 8 rolls	107214, 8 rolls		5 x 111847	2 x 107375	107950

¹ Shingles are available in different colours - 107180 = Black, 107182 = Red, 107183 = Green, 107181 = Brown.



Grace 8,1+8,1 m²



MODERN LOOK

PALMAKO MODERN
LOOK HOUSES

126-137

GRACE FAMILY BY PALMAKO



Grace 8,1+4,1 m²

Palmako's new Modern Look Grace family houses are born from constant unrest to create something new and exciting.

These cabins are extraordinary due to the innovative solution for wall construction – special profile of glue laminated timber wall panels. Glue laminated timber is stable and durable base material, that is also wonderfully easy to set up.

The creation of such products is possible, since Palmako's investment into the new fully automatic production line of laminated timber.

Glue laminated wood ensures, that the building does not sink after completing. Unlike conventional laminated timber houses, new wall panel profile is unique - it is thin and high and the tenon joints stay tighter by being covered with a slat.

To reach the full height of the house, only 4 panels on top of each other are needed. When the lifting height of an ordinary milling beam is 114 mm, the new wall panel has a lifting height of 518 mm, which means that the surface of the wall remains smoother. Laminated timber is stable (no expansion-contraction or distortion), has a beautiful structure (no fissures

or defects) and has a good fire resistance and heat insulation.

New innovative garden house family has seven modern cabins. The first four, Grace 8,1+4,1 m², Grace 8,1+8,1 m², Grace 12,4+4,1 m² and Grace 14,5 m², differ only in size and purpose. Why not create a cozy home office in a small cabin with a shorter canopy roof or use the Grace with a longer canopy roof as a sauna or pool house. Grace 12.4+4.1 m² with two rooms is perfect for accommodate friends or relatives. The largest Grace can probably obtain the most functions.

The next three cabins, Grace 11,2 m² Slide Plus, Grace 11,2+8,2 m² Slide Plus and Grace 14,1 m² Slide Plus, take the Modern Look category to the next level. These house models have sliding doors with double toughened 4-16-4 mm glass. The large glass surfaces let more light into the house and allow a great view from inside out. The dark grey colour RAL7016 of the sliding doors frame suits well with any treatment. Please read more about the sliding doors on pages 360-361.



All Modern Look garden houses use innovative glue laminated wall panels. Lifting height of 518 mm makes an installation of the house easy and fast.

Modern wall corner connection of glue laminated wall panels is fixed with dowels and secured by screws.

Stable and weatherproof corner and log connections are guaranteed by using self-adhesive sealing.

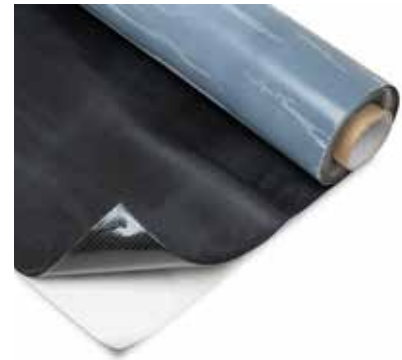

Premium quality windows and door

The quality of Grace houses doors and windows is the best in its class. Laminated timber door frames, high quality classy oak-aluminium combined door sill, double toughened glass and premium lock system. Windows are with one-hand tilt-and-turn system with double toughened glass.

Foundation joists and floor boards

Foundation joists of the Grace houses are treated to guarantee long lifetime to the basis of the house. Solid 28 mm floor boards and floor slats are included in the house kit.

Roof construction

Strong glue laminated rafters carry 19 mm roof boards. To ensure water resistance of roof, we strongly recommend to use solid EPDM roof covering for these pent roof house models.

Paint finishing options

The doors/windows can be delivered from the factory with paint finishing, and the colour shade can be chosen from RAL colour chart. The most popular colour tones are:



RAL 1001



RAL 3009



RAL 6006



RAL 7016



RAL 9005



RAL 9010

NB! Colours as shown in the catalogue may vary from the actual colours.



PALMAKO MODERN
LOOK HOUSE
GRACE 8,1+4,1 m²



PALMAKO MODERN
LOOK HOUSE
GRACE 8,1+8,1 m²



PALMAKO MODERN
LOOK HOUSE
GRACE 12,4+4,1 m²



PALMAKO MODERN
LOOK HOUSE
GRACE 14,5 m²



PALMAKO MODERN
LOOK HOUSE
GRACE 11,2 m² SLIDE PLUS



PALMAKO MODERN
LOOK HOUSE
GRACE 11,2+8,2 m² SLIDE PLUS



PALMAKO MODERN
LOOK HOUSE
GRACE 14,1 m² SLIDE PLUS

PALMAKO MODERN LOOK HOUSE GRACE

8,1+4,1 m²

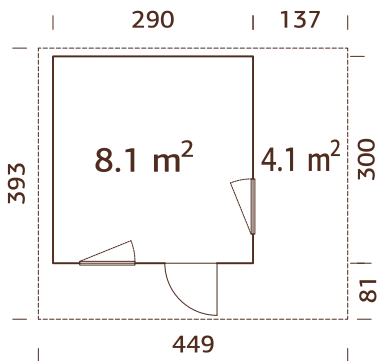

MODEL SPECIFICATIONS

Wall measurements:

290+137x300 cm

Volume: 18,8 m³

Door/window type: Living

Door/window glass: Double toughened glass, 4-18-4 mm

Window opening

measurements: 50x150 cm

Door opening

measurements: 70x193 cm

Door sill: high quality classy oak-aluminium combined door sill

Roof boards: 19 mm

Roof area: 17,5 m²

Roof gradient: 5,0°

Gross ground area: 8,7+4,1 m²

Glue laminated wall panels.
Strong purlins from laminated wood.

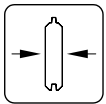

56 mm

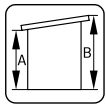

A: 215 cm
B: 258 cm

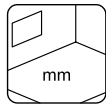

Included
28 mm

OPTIONAL

Roofing felt (underlayer): 3 rolls, SBS roofing material: 3 rolls, roofing nails, EPDM, rain gutters, additional door and window.

PALMAKO MODERN LOOK HOUSE GRACE

8,1+8,1 m²

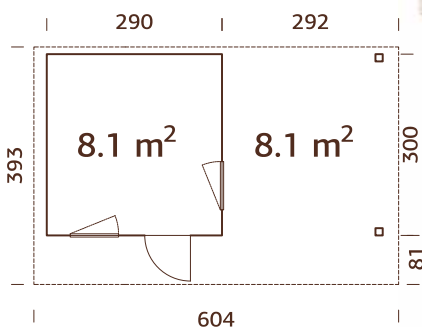

MODEL SPECIFICATIONS

Wall measurements:

290+292x300 cm

Volume: 18,8 m³

Door/window type: Living

Door/window glass: Double toughened glass, 4-18-4 mm

Window opening

measurements: 50x150 cm

Door opening

measurements: 70x193 cm

Door sill: high quality classy oak-aluminium combined door sill

Roof boards: 19 mm

Roof area: 23,7 m²

Roof gradient: 5,0°

Gross ground area: 8,7+8,1 m²

Glue laminated wall panels.
Strong purlins from laminated wood.

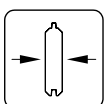

56 mm

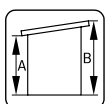

A: 215 cm
B: 258 cm

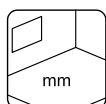

Included
28 mm

OPTIONAL

Roofing felt (underlayer): 5 rolls, SBS roofing material: 5 rolls, roofing nails, EPDM, rain gutters, additional door and window.

PALMAKO MODERN LOOK HOUSE GRACE

12,4+4,1 m²

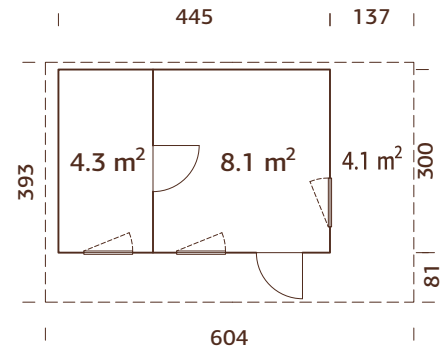

MODEL SPECIFICATIONS

Wall measurements:

445+137x300 cm

Volume: 28,8 m³

Door/window type: Living

Door/window glass: Double toughened glass, 4-18-4 mm

Window opening

measurements: 50x150 cm

Door opening

measurements: 70x193 cm

Door sill: high quality classy oak-aluminium combined door sill

Roof boards: 19 mm

Roof area: 23,7 m²

Roof gradient: 5,0°

Gross ground area:

13,4+4,1 m²

Glue laminated wall panels.

Strong purlins from laminated wood.

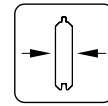

56 mm

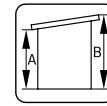

A: 215 cm

B: 258 cm

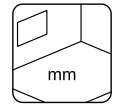

Included

28 mm

OPTIONAL

Roofing felt (underlayer): 5 rolls, SBS roofing material: 5 rolls, roofing nails, EPDM, rain gutters, additional door and window.



Grace 12,4+4,1 m²

PALMAKO MODERN LOOK HOUSE GRACE 14,5m²

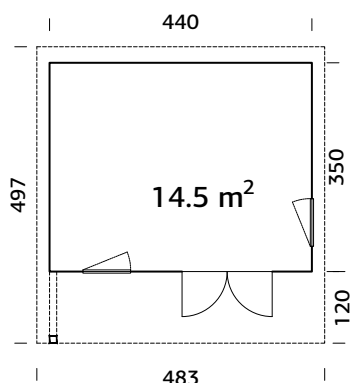

Glue laminated wall panels.
Strong purlins from laminated wood.

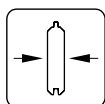

56 mm

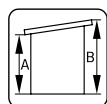

A: 227 cm
B: 279 cm

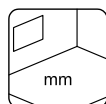

Included
28 mm

MODEL SPECIFICATIONS

Wall measurements:

440x350 cm

Volume: 35,2 m³

Door/window type: Living

Door/window glass: Double
toughened glass, 4-18-4 mm

Window opening

measurements: 50x150 cm

Door opening

measurements: 150x188 cm

Door sill: high quality classy
oak-aluminium combined
door sill

Roof boards: 19 mm

Roof area: 24,0 m²

Roof gradient: 5,0°

Gross ground area:
15,4 m²

OPTIONAL

Roofing felt (underlayer): 4 rolls, SBS roofing material: 4 rolls, roofing nails, EPDM, rain gutters, additional door and window.



PALMAKO MODERN LOOK HOUSE GRACE

11,2m² SLIDE PLUS



MODEL SPECIFICATIONS

Wall measurements:

400x300 cm

Volume: 27,4 m³

Sliding door opening measurements (three sheets):

174x192 cm

Roof boards: 19 mm

Roof area: 17,8 m²

Roof gradient: 5,0°

Gross ground area: 12,0 m²

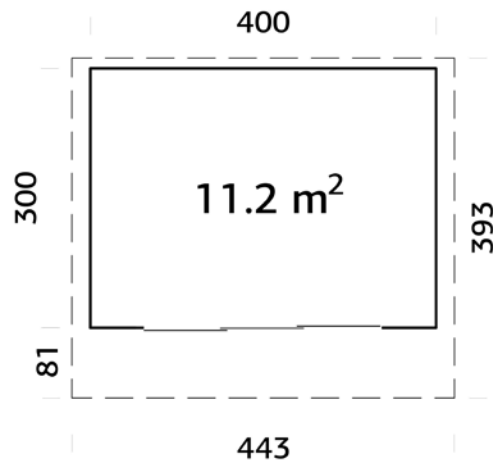

OPTIONAL

Roofing felt (underlayer): 3 rolls, SBS roofing material: 3 rolls, roofing nails, EPDM, rain gutters.



Slide Plus

Double glass, toughened, 4-16-4 mm

- Modern corner connection.
- Sliding doors included.
- Glue laminated wall panels.
- Strong purlins from laminated wood

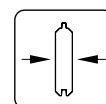

56 mm

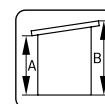

A: 231 cm
B: 274 cm

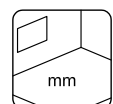

Included
28 mm

PALMAKO MODERN LOOK HOUSE GRACE

11,2+8,2m² SLIDE PLUS

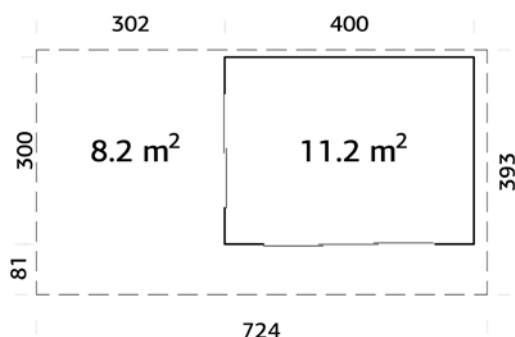

MODEL SPECIFICATIONS

Wall measurements:

400+302x300 cm

Volume: 27,4+20,4 m³

Sliding door opening measurements (two sheets):

85x192 cm

Sliding door opening measurements (three sheets):

174x192 cm

Roof boards: 19 mm

Roof area: 29,3 m²

Roof gradient: 5,0°

Gross ground area: 20,4 m²

OPTIONAL

Roofing felt (underlayer): 5 rolls, SBS roofing material: 5 rolls, roofing nails, EPDM, rain gutters.

- Modern corner connection.
- Sliding doors included.
- Glue laminated wall panels.
- Strong purlins from laminated wood

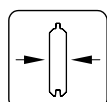

56 mm

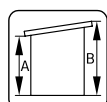

A: 231 cm

B: 274 cm

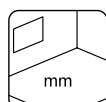

Included

28 mm



Slide Plus

Double glass, toughened, 4-16-4 mm

PALMAKO MODERN LOOK HOUSE GRACE

14,1 m² SLIDE PLUS



MODEL SPECIFICATIONS

Wall measurements:

500x300 cm

Volume: 34,4 m³

Sliding door opening measurements (two sheets):

85x192 cm

Sliding door opening measurements (three sheets):

174x192 cm

Roof boards: 19 mm

Roof area: 25,4 m²

Roof gradient: 5,0°

Gross ground area: 15,0 m²

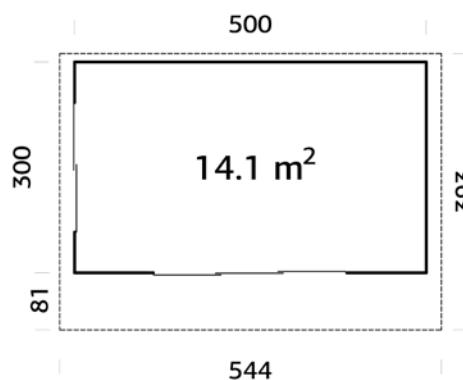

OPTIONAL

Roofing felt (underlayer): 5 rolls, SBS roofing material: 5 rolls, roofing nails, EPDM, rain gutters.



Slide Plus

Double glass, toughened, 4-16-4 mm

Modern corner connection.
Sliding doors included.
Glue laminated wall panels.
Strong purlins from laminated wood

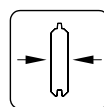

56 mm

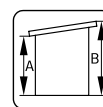

A: 231 cm

B: 274 cm

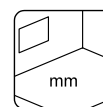

Included

28 mm

OPTIONAL PRODUCTS

SEE OPTIONAL PRODUCTS, PAGES 344-368



House	Art. No.	Roofing felt, rolls	SBS roofing material, rolls	Roofing nails 1 kg	EPDM	Rain gutters
Grace 8,1+4,1 m ²	108586	107210 3 rolls	107214 3 rolls	107930	2 x 111847	107375
Grace 8,1+8,1 m ²	108587	107210 5 rolls	107214 5 rolls	107930	2 x 111847	106628
Grace 12,4+4,1 m ²	108588	107210 5 rolls	107214 5 rolls	107930	2 x 111847	106628
Grace 14,5 m ²	108922	107210 4 rolls	107214 4 rolls	107930	2 x 111847	106628
Grace 11,2 m ² Slide Plus	110998	107210, 3 rolls	107214 5 rolls	107930	2 x 111847	107375
Grace 11,2+8,2 m ² Slide Plus	110997	107210, 5 rolls	107214 5 rolls	107930	3 x 111847	2x 106627
Grace 14,1 m ² Slide Plus	110994	107210, 5 rolls	107214 2 rolls	107930	2 x 111847	106628



PALMAKO MODERN
LOOK HOUSES
126-137

Grace 12,4+4,1 m² interior view



Ly 13,6 m²



NORDIC & NORDIC+ HOUSES

FAST & EASY ASSEMBLY



Internal view, walls covered with wind-protection film

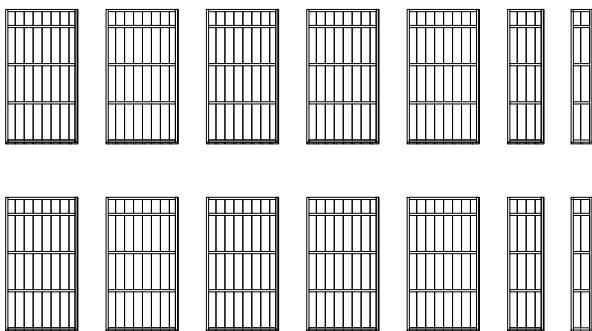

Wall elements – 10 + 2 + 2 pc

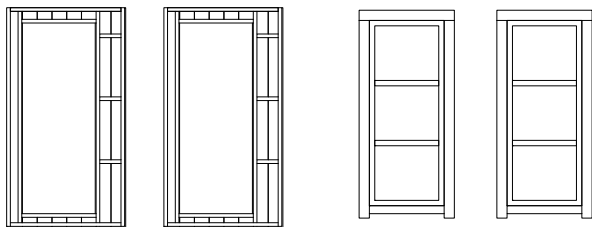

Window elements + windows – 2 pc

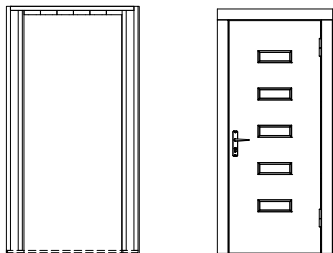

Door element + door – 1 pc

Ready-made elements and simple construction allow for fast and easy assembly. Installation video for the Ly model can be viewed at www.palmako.com/eng/ly



Scan this QR-code to see assembling of Ly 13,6 m²!



Storage
Convenient to store large quantities outdoors; the model is kept in stock all year around.



Mounting foundation and floor boards
Treated foundation joists and 19 mm floor boards.
45 min



Installing rafters and roof boards
Ready-made rafters make roof installation easy and fast, roof boards are 19 mm.
1 h 30



Covering roof with felt or shingles
Roofing felt is the easiest and fastest way to protect the roof boards against the weather.
1 h



Unpacking and sorting building units
House kits are compact and contain all the needed accessories for assembly.
30 min



Installing wall elements
Ready made wall-elements, covered with wind-protection plastic inside.
1 h



Placing door and windows
Double glazed windows ensure good thermal resistance. All windows can be opened.
1 h



6–8 hours



WE HAVE A GREAT ALTERNATIVE TO THE TRADITIONAL GARDEN HOUSE!

These contemporary-style buildings with a Scandinavian look and quality are most suitable for a city garden. Palmako Nordic Houses represent our most modern and innovative pre-fabricated house models.

Ready-made wall elements are covered with wind-protection plastic inside, making these houses extremely weatherproof, especially rain and wind resistant. 70 mm frame construction is perfect for hiding cabling (wires, pipes, etc) as well as for the same thickness of insulation. All the houses have double thermo glazing and outwards-opening windows.

These models have 40 mm EPS (Expanded polystyrene) insulated doors, which makes them especially rain and wind resistant.

Total element thickness by Nordic houses is 88 mm. Here is a cross section of an element just to get better understanding of what these elements look like and consist of:

1. Plywood 10mm
2. Plywood 10mm
3. EPS 50 40mm insulation
4. Wooden skeleton 40x40mm
5. Wooden laminated frame 44x105mm
6. Hardwood 28x93mm threshold
7. Hinge 115x84x3mm (3x)
8. 565 lock and lock box

1. 34x70mm frame
2. Wind-protection plastic
3. 18mm fine sawn cladding

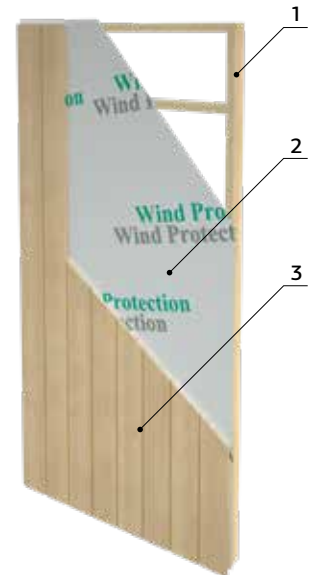
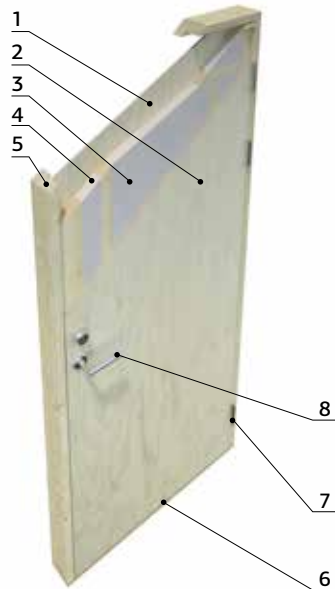

PALMAKO NORDIC HOUSE LY 13,6 m²



ONE SET – MANY HOUSES!

A model contains a set of wall and window-door elements, which can be rearranged in several ways. This results in multiple appearance options for the house.





PALMAKO NORDIC HOUSE
LY 13,6 m²



PALMAKO NORDIC+ HOUSE
CHARLOTTE 21,5 m²



PALMAKO NORDIC HOUSE
HEDWIG 13,6 m²



PALMAKO NORDIC+ HOUSE
PERNILLA 21,5 m²



PALMAKO NORDIC HOUSE
ETTA 13,6 m²



PALMAKO NORDIC+ HOUSE
ANNIKA 21,5 m²



PALMAKO NORDIC HOUSE
SIMONE 13,6 m²



PALMAKO NORDIC HOUSE
ANNABEL 13,4 m² KIT



PALMAKO NORDIC HOUSE
ANNABEL 13,4 m² SLIDE

PALMAKO NORDIC HOUSE LY 13,6 m²

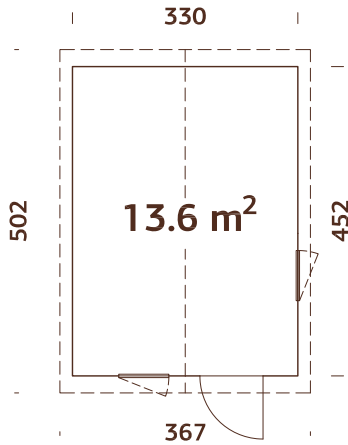

Door and window elements are interchangeable.

Double glazed.

Ready-made wall elements

with wind protection plastic!

Trendy look! Fine-sawn cladding.



18+70 mm

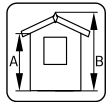

A: 203 cm
B: 297 cm

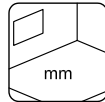

Included
19 mm

MODEL SPECIFICATIONS

Wall measurements:

330x452 cm

Volume: 35,2 m³

Door/window type: Summer

Door/window glass:

Double glass, 3-9-3 mm

Window opening

measurements:

57x165 cm

Door opening

measurements: 78x191 cm

Door sill: hard wood

Roof boards: 19 mm

Roof area: 19,5 m²

Roof gradient: 20,0°

Gross ground area: 14,9 m²

OPTIONAL

Roofing felt (underlayer): 5 rolls, SBS roofing material: 5 rolls, shingles: 8 packs, roofing nails, rain gutters, additional door and window.

PALMAKO NORDIC HOUSE HEDWIG 13,6 m²

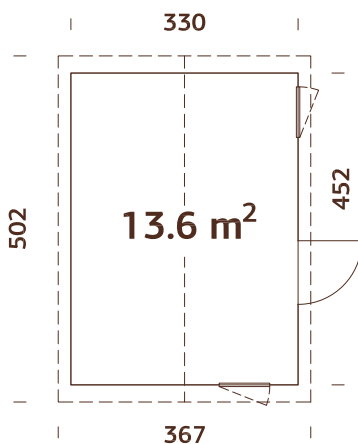

Door and window elements are interchangeable. Double glazed.

Ready-made wall elements

with wind protection plastic!

Trendy look! Fine-sawn cladding.

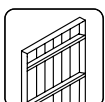

18+70 mm

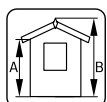

A: 203 cm
B: 297 cm

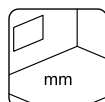

Included
19 mm

MODEL SPECIFICATIONS

Wall measurements:

330x452 cm

Volume: 35,2 m³

Door/window type: Summer

Door/window glass:

Double glass, 3-9-3 mm

Window opening

measurements:

57x86 cm

Door opening

measurements: 78x191 cm

Door sill: hard wood

Roof boards: 19 mm

Roof area: 19,5 m²

Roof gradient: 20,0°

Gross ground area: 14,9 m²

OPTIONAL

Roofing felt (underlayer): 5 rolls, SBS roofing material: 5 rolls, shingles: 8 packs, roofing nails, rain gutters, additional door and window.

PALMAKO NORDIC HOUSE ETTA 13,6 m²

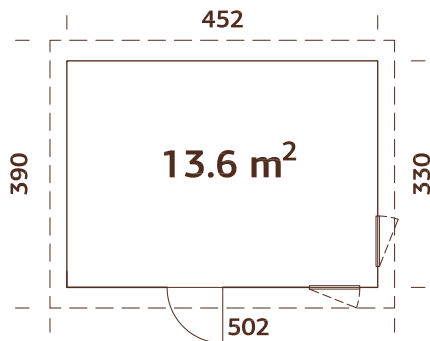

Door and window elements are interchangeable. Double glazed. Ready-made wall elements with wind protection plastic! Trendy look! Fine-sawn cladding.



18+70 mm

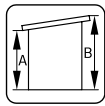

A: 203 cm
B: 294 cm

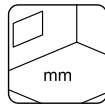

Included
19 mm

MODEL SPECIFICATIONS

Wall measurements:

452x330 cm

Volume: 33,7 m³

Door/window type: Summer

Window glass:

Double glass, 3-9-3 mm

Door glass:

Double glass, 4-9-4 mm

Window opening measurements: 57x165 cm

Door opening

measurements: 78x191 cm

Door sill: hard wood

Roof boards: 19 mm

Roof area: 19,7 m²

Roof gradient: 9,0°

Gross ground area: 14,9 m²

OPTIONAL

Roofing felt (underlayer): 5 rolls, SBS roofing material: 5 rolls, roofing nails, EPDM, rain gutters, additional door and window.

PALMAKO NORDIC HOUSE SIMONE 13,6 m²

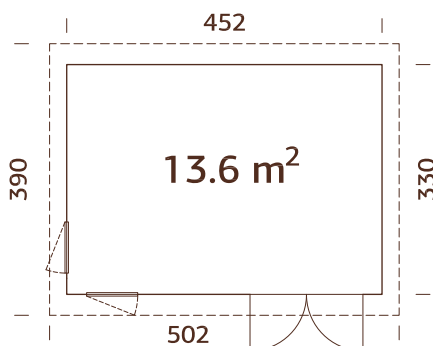

Door and window elements are interchangeable. Double glazed. Ready-made wall elements with wind protection plastic! Trendy look! Fine-sawn cladding.

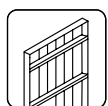

18+70 mm

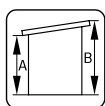

A: 203 cm
B: 294 cm

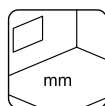

Included
19 mm

MODEL SPECIFICATIONS

Wall measurements:

452x330 cm

Volume: 33,7 m³

Door/window type: Summer

Window glass:

Double glass, 3-9-3 mm

Window opening measurements:

54x162 cm

Door glass:

Double glass, 4-9-4 mm

Door opening

measurements: 151x180 cm

Door sill: low, covered with stainless steel

Roof boards: 19 mm

Roof area: 19,7 m²

Roof gradient: 9,0°

Gross ground area: 14,9 m²

OPTIONAL

Roofing felt (underlayer): 5 rolls, SBS roofing material: 5 rolls, roofing nails, EPDM, rain gutters, additional door and window.

PALMAKO NORDIC HOUSE ANNABEL 13,4 m² SLIDE



Annabel 13,4 m² kit without sliding door

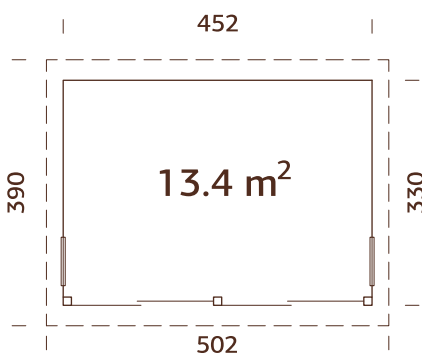

Ready-made wall elements with wind protection plastic!
Trendy look! Fine-sawn cladding.

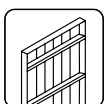

18+70 mm

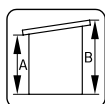

A: 205 cm
B: 294 cm

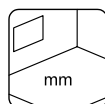

Included
19 mm

MODEL SPECIFICATIONS

Wall measurements: 452x330 cm

Volume: 37,4 m³

Door: Sliding door set

Door glass: Toughened, 5 mm

Window type: Summer

Window glass:

Double glass, 3-9-3 mm

Window opening

measurements: 57x165 cm

Door opening

measurements: 96x196 cm

Roof boards: 19 mm

Roof area: 20,0 m²

Roof gradient: 9,0°

Gross ground area: 15,1 m²

OPTIONAL

Roofing felt (underlayer): 3 rolls, SBS roofing material: 3 rolls, roofing nails, EPDM, rain gutters, additional door and window.



Slide

Single glass, toughened, 4 mm

PRE-FABRICATED PALMAKO NORDIC+ HOUSES WITH ELEMENT THICKNESS OF 160 MM

These Scandinavian-style houses are suitable for any garden that lacks strong, weather-resistant buildings where you can be with your family and friends. Feel free to take your time and delve into the following pages of our best choice of modern, pre-fabricated Nordic+ houses.

Ready-made wall elements are covered with wind-protection plastic inside, making these houses extremely weatherproof, especially rain and wind-resistant. It is comfortable to be in a building when it is warm - we have thought about it and given you an opportunity for 95 mm insulation. You can insulate walls, floors and ceilings. For better house ventilation we have added ventilation battens under the cladding. All the houses have double thermo glazing and outwards-opening windows. These models have 40 mm EPS (expanded polystyrene) insulated doors.

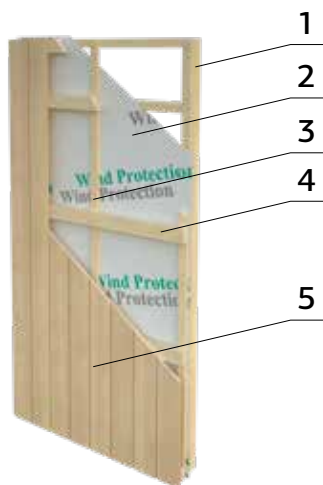

Total element thickness of Nordic+ houses is 160 mm. Here is a cross section of an element just to get a better understanding of what these elements look like and consist of:

1. 44x95mm frame
2. Wind-protection plastic
3. 19x45mm ventilation battens
4. 28x70mm cladding support battens
5. 18mm fine sawn cladding

One set – many houses!

A model contains set of wall and window-door elements, which can be rearranged in several ways. This results in multiple appearance options for the house.

PALMAKO NORDIC+ HOUSE CHARLOTTE 21,5 m²



CHARLOTTE OPTION 1



CHARLOTTE OPTION 2



CHARLOTTE OPTION 3



CHARLOTTE OPTION 4



PALMAKO NORDIC+ HOUSE CHARLOTTE 21,5 m²

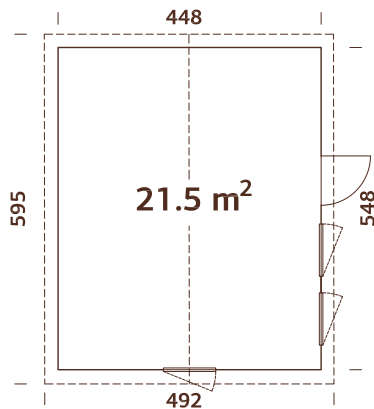

Door and window elements are interchangeable.
 Double glazed.
 Trendy look! Fine-sawn cladding.
 Ready-made wall elements with wind protection plastic!



160 mm

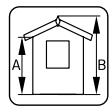

A: 216 cm
 B: 326 cm

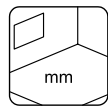

Included
 19 mm

MODEL SPECIFICATIONS

Wall measurements:

448x548 cm

Volume: 55,4 m³

Door/window type: Summer

Door/window glass:

Double glass, 3-9-3 mm

Window opening measurements:

57x165, 69x38 cm

Door opening measurements:

78x191 cm

Door sill: hard wood

Roof boards: 19 mm

Roof area: 30,4 m²

Roof gradient: 20,0°

Gross ground area: 24,6 m²

OPTIONAL

Roofing felt (underlayer): 7 rolls, SBS roofing material: 7 rolls, shingles: 13 packs, roofing nails, rain gutters, canopy roof, additional door and window.

PALMAKO NORDIC+ HOUSE PERNILLA 21,5 m²

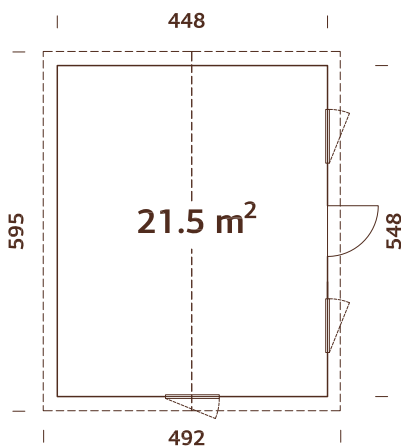

Door and window elements are interchangeable.
 Double glazed.
 Trendy look! Fine-sawn cladding.
 Ready-made wall elements with wind protection plastic!

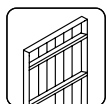

160 mm

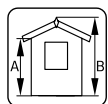

A: 216 cm
 B: 326 cm

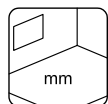

Included
 19 mm

MODEL SPECIFICATIONS

Wall measurements:

448x548 cm

Volume: 55,4 m³

Door/window type: Summer

Door/window glass:

Double glass, 3-9-3 mm

Window opening measurements:

69x38 cm, 69x86 cm

Door opening measurements:

78x181 cm

Door sill: hard wood

Roof boards: 19 mm

Roof area: 30,4 m²

Roof gradient: 20,0°

Gross ground area: 24,6 m²

OPTIONAL

Roofing felt (underlayer): 7 rolls, SBS roofing material: 7 rolls, shingles: 13 packs, roofing nails, rain gutters, canopy roof, additional door and window.

PALMAKO NORDIC+ HOUSE ANNIKA 21,5 m²

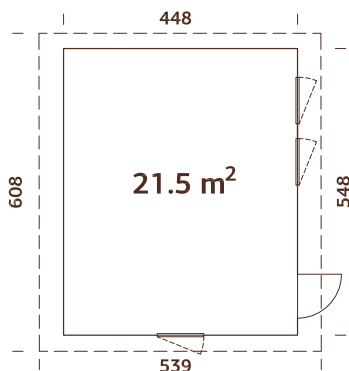

Door and window elements are interchangeable.
 Double glazed.
 Trendy look! Fine-sawn cladding.
 Ready-made wall elements with wind protection plastic!

MODEL SPECIFICATIONS

Wall measurements:

448x548 cm

Volume: 55,0 m³

Door/window type: Summer

Door/window glass:

Double glass, 3-9-3 mm

Window opening

measurements: 57x165 cm

Door opening

measurements: 78x191 cm

Door sill: hard wood

Roof boards: 19 mm

Roof area: 33,2 m²

Roof gradient: 7,0°

Gross ground area: 24,6 m²



160 mm

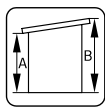

A: 216 cm

B: 311 cm

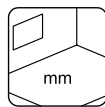

Included

19 mm

OPTIONAL

Roofing felt (underlayer): 6 rolls, SBS roofing material: 6 rolls, roofing nails, EPDM, rain gutters, additional door and window.



OPTIONAL PRODUCTS

SEE OPTIONAL PRODUCTS, PAGES 344-368

House	Art. No.	Roofing felt, rolls	SBS roofing material, rolls	Shingles ¹ , packs	Roofing nails, 1 kg	EPDM	Rain gutters
Ly 13,6 m ²	101147	107210 5 rolls	107214 5 rolls	8 packs	107950		106632
Hedwig 13,6 m ²	101163	107210 5 rolls	107214 5 rolls	8 packs	107950		106632
Etta 13,6 m ²	101151	107210 5 rolls	107214 5 rolls		107950	2 x 111847	107375
Simone 13,6 m ²	109000	107210 5 rolls	107214 5 rolls		107950	2 x 111847	107375
Annabel 13,4 m ² Slide	108994	107210 3 rolls	107214 3 rolls		107950	2 x 111847	107375
Annabel 13,4 m ² Klt	109044	107210 3 rolls	107214 3 rolls		107950	2 x 111847	107375
Charlotte 21,5 m ²	101253	107210 7 rolls	107214 7 rolls	13 packs	2 x 107950		106632
Perilla 21,5 m ²	101261	107210 7 rolls	107214 7 rolls	13 packs	2 x 107950		106632
Annika 21,5 m ²	101257	107210 6 rolls	107214 6 rolls		107950	3 x 111847	106626 + 106627

¹ Shingles are available in different colours - 107180 = Black, 107182 = Red, 107183 = Green, 107181 = Brown.



Hanna 20,3 m²



PAVILIONS

PAVILIONS

NEW



PALMAKO PAVILION
MELANIE LOW 7,0 m²



PALMAKO PAVILION
MELANIE 7,0 m²



PALMAKO PAVILION
MELANIE 6,9 m²



PALMAKO PAVILION
MELANIE 9,9 m²



PALMAKO PAVILION
MELANIE 7,0+8,1 m²



PALMAKO PAVILION
HANNA 7,6 m²



PALMAKO PAVILION
HANNA 14,1 m²



PALMAKO PAVILION
HANNA 20,3 m²



PALMAKO PAVILION
VERONICA 2 6,7 m²



PALMAKO PAVILION
VERONICA 4 6,7 m²



PALMAKO PAVILION
VERONICA 4 9,2 m²



PALMAKO PAVILION
VERONICA 7 9,2 m²



PALMAKO PAVILION
BETTY 9,0 m²



PALMAKO PAVILION
BETTY 9,9 m²



PALMAKO PAVILION
BETTY 18,0 m²



PALMAKO PAVILION
BETTY 25,0 m²



PALMAKO PAVILION
JULIE 10,5 m²



PALMAKO PAVILION
LUCY 12,2 m²

NEW



PALMAKO PAVILION
ISABELLA 10,9 m²



PALMAKO PAVILION
ISABELLA 14,7 m²

NEW



PALMAKO PAVILION
ISABELLA 22,2 m²

NEW



PALMAKO GLASSHOUSE
EMILIA 5,4 m²



PALMAKO GLASSHOUSE
EMILIA 8,2 m²



PALMAKO EMILIA
SHED 4,0 m²



PALMAKO GLASSHOUSE
EMILIA 13,8 m²



PALMAKO GLASSHOUSE
EMILIA 19,1 m²



PALMAKO GRILL KOTA
EVA 8,7 m²



PALMAKO GRILL KOTA
EVA 11,4 m²

PALMAKO PAVILION MELANIE LOW 7,0 m²

NEW!

under 2,5m

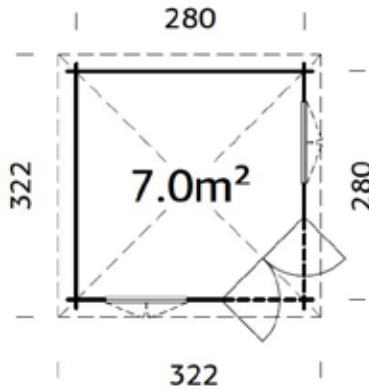

MODEL SPECIFICATIONS

- Log measurements:**
300x300 cm
- Volume:** 16,3 m³
- Door/window type:**
Garden
- Window glass:**
Real glass, 4 mm
- Door glass:** Toughened glass, 4 mm
- Window opening measurements:** 90x144 cm
- Door opening measurements:** 134x175 cm
- Door sill:** low, covered with stainless steel
- Roof boards:** 16 mm
- Roof area:** 10,2 m²
- Roof gradient:** 8,0°
- Gross ground area:** 7,8 m²



TREATMENT

Available dipped

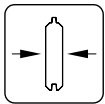

28 mm

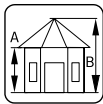

A: 217 cm
B: 245 cm

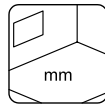

Included
19 mm

OPTIONAL

Roofing felt (underlayer): 2 rolls, SBS roofing material: 2 rolls, roofing nails, rain gutters, EPDM, additional door and window.



Window bar profile
16x24 mm

PALMAKO PAVILION MELANIE 7,0 m²

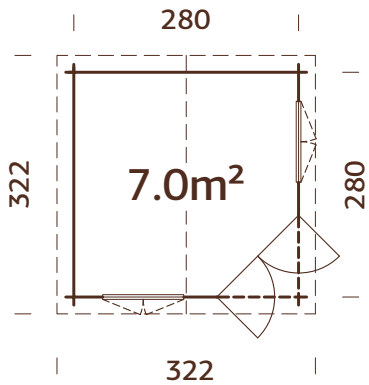

MODEL SPECIFICATIONS

- Log measurements:**
300x300 cm
- Volume:** 17,4 m³
- Door/window type:**
Garden
- Window glass:**
Real glass, 4 mm
- Door glass:** Toughened glass, 4 mm
- Window opening measurements:** 90x144 cm
- Door opening measurements:** 134x175 cm
- Door sill:** low, covered with stainless steel
- Roof boards:** 16 mm
- Roof area:** 11,9 m²
- Roof gradient:** 25,0°
- Gross ground area:** 7,8 m²



TREATMENT

Available dipped

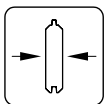

28 mm

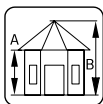

A: 217 cm
B: 297 cm

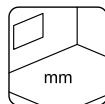

Included
19 mm

OPTIONAL

Shingles: 6 packs, roofing nails, additional door and window.



Window bar profile
16x24 mm

PALMAKO PAVILION MELANIE 6,9 m²



Window bar profile
16x24 mm

MODEL SPECIFICATIONS

Log measurements:

300x300 cm

Volume: 16,3 m³

Door/window type:

Garden+

Window glass: Double glass,
3-6-3 mm

Door glass: Double
toughened glass, 4-6-4 mm

**Window opening
measurements:** 90x123 cm

**Door opening
measurements:**

114x186 cm

Door sill: low,
covered with stainless steel

Roof boards: 16 mm

Roof area: 8,4 m²

Roof gradient: 25,0°

Gross ground area: 7,8 m²

OPTIONAL

Shingles: 6 packs, roofing nails,
additional door and window.

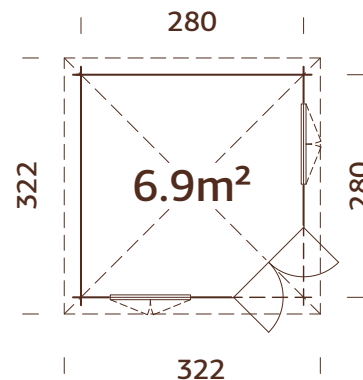

Double glazed.

TREATMENT

Available dipped

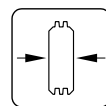

44 mm

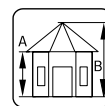

A: 222 cm

B: 308 cm

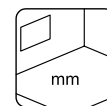

Included

19 mm

PALMAKO PAVILION MELANIE 9,9 m²



Scan this QR-code
to see the assembly
of Melanie 9,9 m²!



Window bar profile
16x24 mm

MODEL SPECIFICATIONS

Log measurements:

350x350 cm

Volume: 27,0 m³

Door/window type: Garden+

Window glass: Double glass,
3-6-3 mm

Door glass: Double toughened
glass, 4-6-4 mm

**Window opening
measurements:** 90x123 cm

**Door opening
measurements:** 114x186 cm

Door sill: low,
covered with stainless steel

Roof boards: 19 mm

Roof area: 17,0 m²

Roof gradient: 24,5°

Gross ground area: 10,9 m²

OPTIONAL

Shingles: 8 packs, roofing nails,
additional door and window.

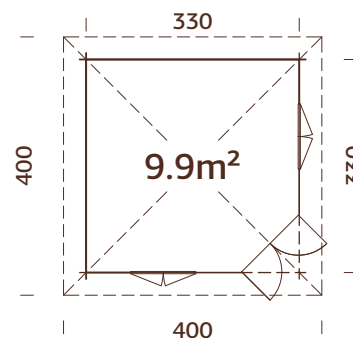

Double glazed.

TREATMENT

Available dipped

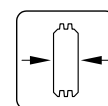

44 mm

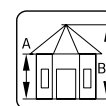

A: 233 cm

B: 325 cm

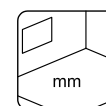

Included

19 mm

PALMAKO PAVILION MELANIE 7,0+8,1 m²

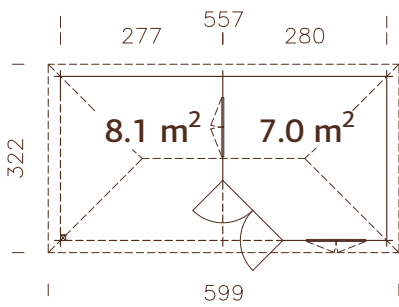

Can be built in reverse!



TREATMENT

Available dipped

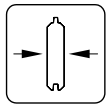

28 mm

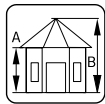

A: 228 cm
B: 307 cm

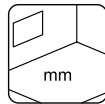

Included
19 mm

MODEL SPECIFICATIONS

Log measurements:

577x300 cm

Volume: 18,6+21,0 m³

Canopy roof: 277x280 cm

Door/window type: Garden

Window glass: Real glass, 4 mm

Door glass: Toughened glass, 4 mm

Window opening measurements: 90x144 cm

Door opening measurements: 134x175 cm

Door sill: low, covered with stainless steel

Roof boards: 16 mm

Roof area: 20,8 m²

Roof gradient: 24,7°

Gross ground area: 15,6 m²



OPTIONAL

Shingles: 10 packs, roofing nails, rain gutters, additional door and window.



Window bar profile
16x24 mm



Melanie 7,0+8,1 m²

PALMAKO PAVILION HANNA 7,6 m²



Window bar profile
16x24 mm

MODEL SPECIFICATIONS

- Diameter:** 303 cm
- Volume:** 19,6 m³
- Door/window type:** Garden
- Window glass:** Real glass, 4 mm
- Door glass:** Toughened glass, 4 mm
- Window opening measurements:** 90x123 cm
- Door opening measurements:** 114x186 cm
- Door sill:** low, covered with stainless steel
- Roof boards:** 16 mm
- Roof area:** 14,8 m²
- Roof gradient:** 32,0°
- Gross ground area:** 8,0 m²

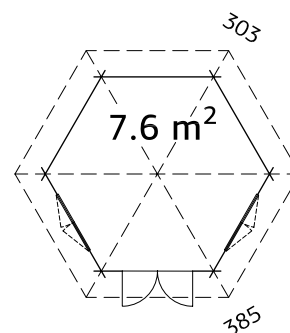

Ready-made roof elements.

TREATMENT

Available dipped

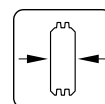

34 mm

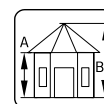

A: 227 cm
B: 336 cm

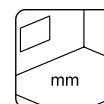

Included
19 mm

OPTIONAL

Shingles: 8 packs, roofing nails, additional door and window.

PALMAKO PAVILION HANNA 14,1 m²



Window bar profile
16x24 mm

MODEL SPECIFICATIONS

- Diameter:** 421 cm
- Volume:** 38,3 m³
- Door/window type:** Garden+
- Window glass:** Double glass, 3-6-3 mm
- Door glass:** Double toughened glass, 4-6-4 mm
- Window opening measurements:** 90x123 cm
- Door opening measurements:** 114x186 cm
- Door sill:** low, covered with stainless steel
- Roof boards:** 16 mm
- Roof area:** 24,0 m²
- Roof gradient:** 32,0°
- Gross ground area:** 14,7 m²

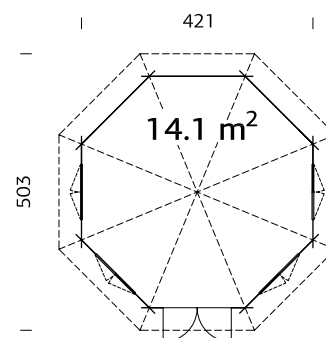

Double glazed.
Ready-made roof elements.

TREATMENT

Available dipped

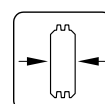

44 mm

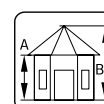

A: 222 cm
B: 371 cm

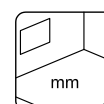

Included
19 mm

OPTIONAL

Shingles: 12 packs, roofing nails, additional door and window.

PALMAKO PAVILION HANNA 20,3 m²

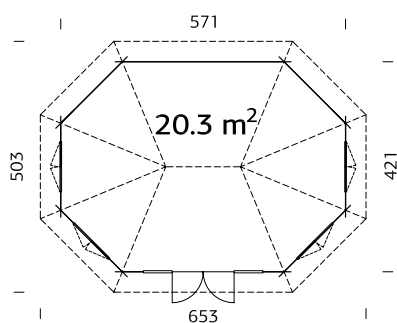

Window bar profile
16x24 mm

Double glazed.
Ready-made roof elements.

TREATMENT

Available dipped

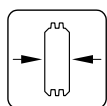

44 mm

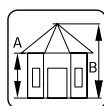

A: 222 cm
B: 371 cm

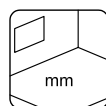

Included
19 mm

MODEL SPECIFICATIONS

Diameter: 421/571 cm

Volume: 53,5 m³

Door/window type:

Garden+

Window glass: Double glass,
3-6-3 mm

Door glass: Double
toughened glass, 4-6-4 mm

**Window opening
measurements:** 90x123 cm

**Door opening
measurements:** 120x183 cm

Door sill: low,
covered with stainless steel

Roof boards: 16 mm

Roof area: 32,6 m²

Roof gradient: 32,0°

Gross ground area: 21,0 m²

OPTIONAL

Shingles: 16 packs, roofing nails, additional door and window.

PALMAKO PAVILION VERONICA 2 6,7 m²



Window bar profile
16x24 mm

MODEL SPECIFICATIONS

- Diameter:** 289 cm
- Volume:** 16,4 m³
- Door/window type:** Garden+
- Window glass:** Double glass, 3-6-3 mm
- Door glass:** Double toughened glass, 4-6-4 mm
- Window opening measurements:** 102x104 cm
- Door opening measurements:** 102x174 cm
- Door sill:** low, covered with stainless steel
- Roof boards:** 16 mm
- Roof area:** 12,6 m²
- Roof gradient:** 32,0°
- Gross ground area:** 6,9 m²

OPTIONAL

Shingles: 7 packs, roofing nails, additional door and window.

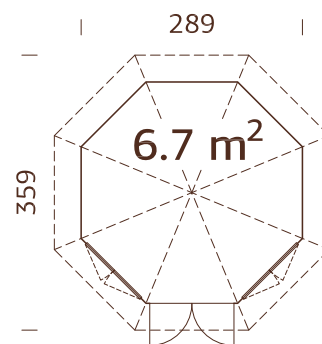

Double glazed.
Ready-made wall and roof elements.

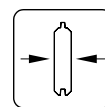

28 mm

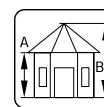

A: 215 cm
B: 310 cm

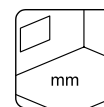

Included
19 mm

PALMAKO PAVILION VERONICA 4 6,7 m²



Window bar profile
16x24 mm

MODEL SPECIFICATIONS

- Diameter:** 289 cm
- Volume:** 16,4 m³
- Door/window type:** Garden+
- Window glass:** Double glass, 3-6-3 mm
- Door glass:** Double toughened glass, 4-6-4 mm
- Window opening measurements:** 102x104 cm
- Door opening measurements:** 102x174 cm
- Door sill:** low, covered with stainless steel
- Roof boards:** 16 mm
- Roof area:** 12,6 m²
- Roof gradient:** 32,0°
- Gross ground area:** 6,9 m²

OPTIONAL

Shingles: 7 packs, roofing nails, additional door and window.

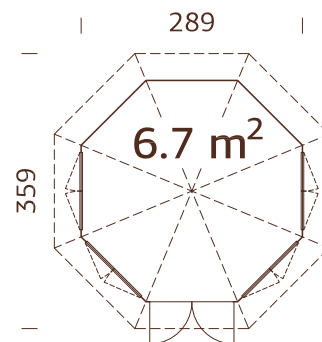

Double glazed.
Ready-made wall and roof elements.

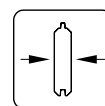

28 mm

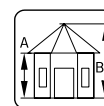

A: 215 cm
B: 310 cm

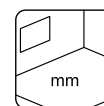

Included
19 mm

PALMAKO PAVILION VERONICA 4 9,2 m²

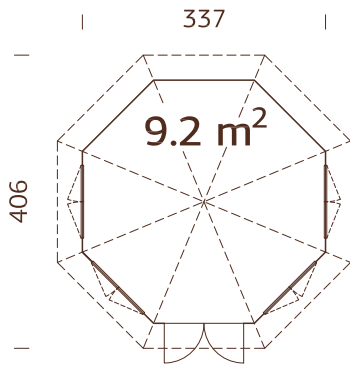

Double glazed.
Ready-made wall and roof elements.

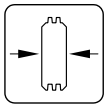

34 mm

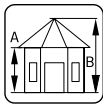

A: 222 cm
B: 326 cm

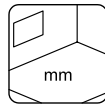

Included
19 mm

MODEL SPECIFICATIONS

- Diameter:** 337 cm
- Volume:** 23,4 m³
- Door/window type:** Garden+
- Window glass:** Double glass, 3-6-3 mm
- Door glass:** Double toughened glass, 4-6-4 mm
- Window opening measurements:** 90x123 cm
- Door opening measurements:** 120x181 cm
- Door sill:** low, covered with stainless steel
- Roof boards:** 16 mm
- Roof area:** 15,3 m²
- Roof gradient:** 32,0°
- Gross ground area:** 9,4 m²



Window bar profile
16x24 mm

OPTIONAL

Shingles: 9 packs, roofing nails, additional door and window.

PALMAKO PAVILION VERONICA 7 9,2 m²

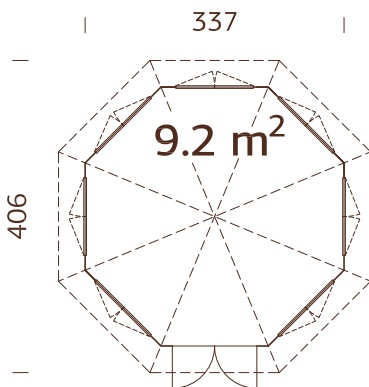

Double glazed.
Ready-made wall and roof elements.

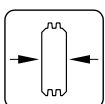

34 mm

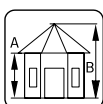

A: 222 cm
B: 326 cm

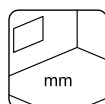

Included
19 mm

MODEL SPECIFICATIONS

- Diameter:** 337 cm
- Volume:** 23,4 m³
- Door/window type:** Garden+
- Window glass:** Double glass, 3-6-3 mm
- Door glass:** Double toughened glass, 4-6-4 mm
- Window opening measurements:** 90x123 cm
- Door opening measurements:** 120x181 cm
- Door sill:** low, covered with stainless steel
- Roof boards:** 16 mm
- Roof area:** 15,3 m²
- Roof gradient:** 32,0°
- Gross ground area:** 9,4 m²



Window bar profile
16x24 mm

OPTIONAL

Shingles: 9 packs, roofing nails, additional door.

PALMAKO PAVILION BETTY 9,0 m²

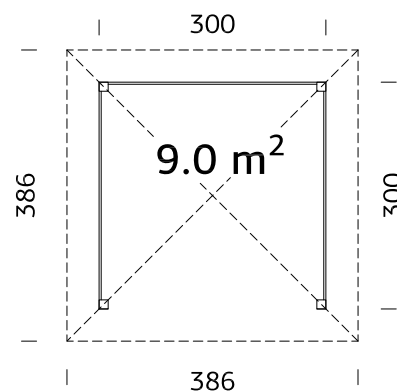

Strong posts from laminated wood.

TREATMENT

- Available dipped
- Available painted

MODEL SPECIFICATIONS

Measurements:

300x300 cm

Volume: 21,9 m³

Roof boards: 19 mm

Roof area: 15,4 m²

Roof gradient: 25,0°

Gross ground area: 9,0 m²

OPTIONAL

Floor, shingles: 8 packs, roofing nails.

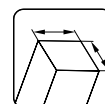

120x120 mm

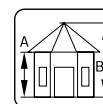

A: 223 cm
B: 323 cm

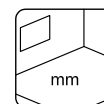

NB! Floor is an optional extra! 28 mm, treated

PALMAKO PAVILION BETTY 9,9 m²

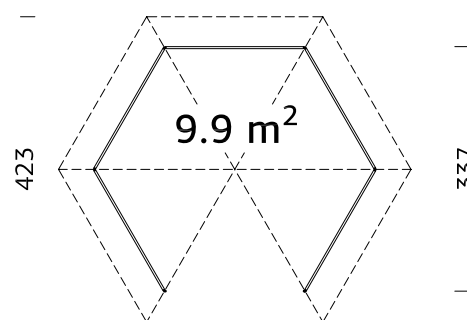

Strong posts from laminated wood.

TREATMENT

- Available dipped
- Available painted

MODEL SPECIFICATIONS

Diameter: 337 cm

Volume: 23,0 m³

Roof boards: 19 mm

Roof area: 16,7 m²

Roof gradient: 25,0°

Gross ground area: 9,9 m²

OPTIONAL

Floor, shingles: 9 packs, roofing nails.

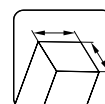

120x120 mm

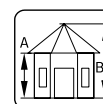

A: 204 cm
B: 313 cm

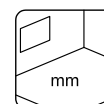

NB! Floor is an optional extra! 28 mm, treated



PALMAKO PAVILION BETTY 18,0 m²

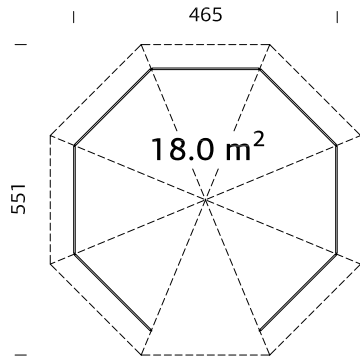

Strong posts from laminated wood.



TREATMENT

- Available dipped
- Available painted

MODEL SPECIFICATIONS

Diameter: 465 cm

Roof boards: 19 mm

Roof gradient: 25,0°

Volume: 46,0 m³

Roof area: 27,2 m²

Gross ground area: 18,0 m²

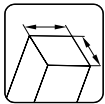

120x120 mm

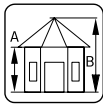

A: 207 cm
B: 346 cm

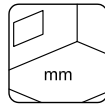

NB! Floor is an optional extra! 28 mm, treated

OPTIONAL

Floor, shingles: 14 packs, roofing nails.

PALMAKO PAVILION BETTY 25,0 m²

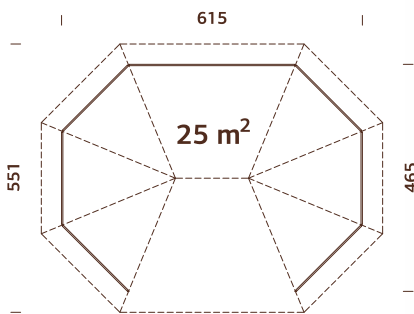

Strong posts from laminated wood.



TREATMENT

- Available dipped
- Available painted

MODEL SPECIFICATIONS

Diameter: 467/617 cm

Roof boards: 19 mm

Roof gradient: 25,0°

Volume: 64,0 m³

Roof area: 36,8 m²

Gross ground area: 25,0 m²

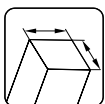

120x120 mm

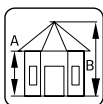

A: 207 cm
B: 362 cm

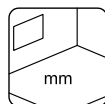

NB! Floor is an optional extra! 28 mm, treated

OPTIONAL

Floor, shingles: 17 packs, roofing nails.

PALMAKO PAVILION JULIE 10,5 m²

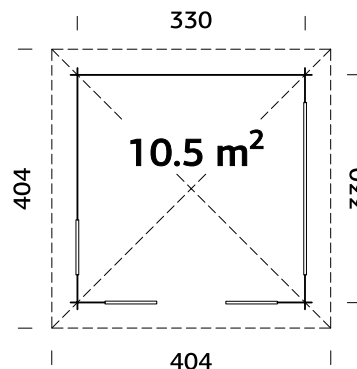

Terrace boards are treated.

MODEL SPECIFICATIONS

Log measurements:

350x350 cm

Volume: 26,0 m³

Roof boards: 19 mm

Roof area: 17,6 m²

Roof gradient: 24,7°

Gross ground area: 10,9 m²

TREATMENT

Available dipped

Available painted

OPTIONAL

Shingles: 9 packs, roofing nails.

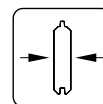

28 mm

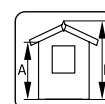

A: 217 cm
B: 310 cm

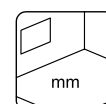

Included
19 mm

PALMAKO PAVILION LUCY 12,2 m²

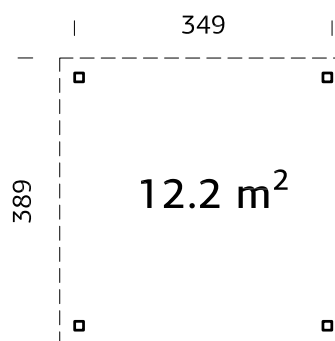

Strong posts from laminated wood.

MODEL SPECIFICATIONS

Measurements: 349x349 cm

Volume: 27,5 m³

Roof boards: 19 mm

Roof area: 15,1 m²

Roof gradient: 1,3°

Gross ground area: 12,2 m²

TREATMENT

Available dipped

Available painted

OPTIONAL

Roofing felt (underlayer): 3 rolls, SBS roofing material: 3 rolls, roofing nails, EPDM, rain gutters, wall elements (solid/glass).



NB! The wall elements are optional extras! See Optional Products.

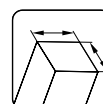

120x120 mm

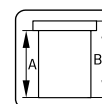

A: 230 cm
B: 254 cm

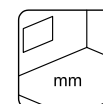

-

PALMAKO PAVILION ISABELLA 10,9 m²

NEW!

NEW!
ALUMINIUM DOORS
AND WINDOWS



Can be built in reverse!

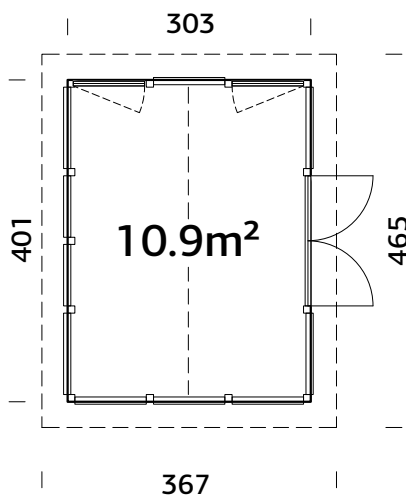

Aluminium doors and windows.

MODEL SPECIFICATIONS

Wall measurements: 303x401 cm

Volume: 27,3 m³

Door/window type: Alu SG

Window glass: Real glass, 4 mm

Door glass: Toughened, 4 mm

Fixed window measurements:

78x153 cm

Window opening measurements:

78x153 cm

Door opening measurements:

176x203 cm

Door sill: low, covered with stainless steel

Roof boards: 16 mm

Roof area: 18,1 m²

Roof gradient: 20,0°

Gross ground area: 12,2 m²

OPTIONAL

Roofing felt (underlayer): 3 rolls, SBS roofing material: 3 rolls, shingles: 8 packs, roofing nails, rain gutters.

TREATMENT

Available dipped

Available painted

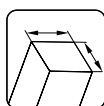

90x90 mm

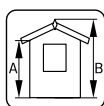

A: 226 cm
B: 297 cm

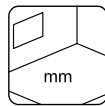

-



Aluminium window
Single glass, 4 mm



Aluminium door
Single glass, toughened, 4 mm

PALMAKO PAVILION ISABELLA 14,7 m²

NEW!

NEW!
ALUMINIUM DOORS
AND WINDOWS



Can be built in reverse!

MODEL SPECIFICATIONS

Wall measurements: 401x401 cm

Volume: 38,2 m³

Door/window type: Alu SG

Window glass: Real glass, 4 mm

Door glass: Toughened, 4 mm

Fixed window measurements:

78x153 cm, 114x50 cm

Window opening measurements:

78x153 cm

Door opening measurements:

176x203 cm

Door sill: low, covered with stainless steel

Roof boards: 16 mm

Roof area: 22,9 m²

Roof gradient: 20,0°

Gross ground area: 16,1 m²

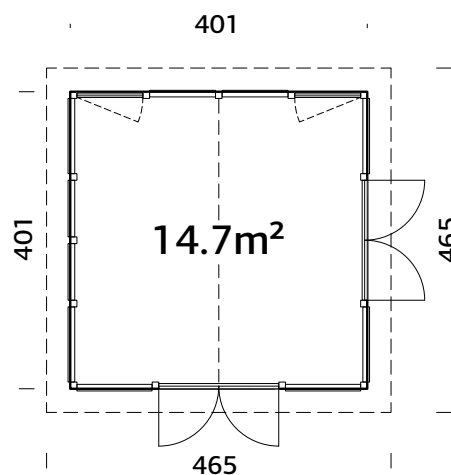

OPTIONAL

Roofing felt (underlayer): 4 rolls, SBS roofing material: 4 rolls, shingles: 9 packs, roofing nails, rain gutters.



Aluminium window
Single glass, 4 mm



Aluminium door
Single glass, toughened, 4 mm

Aluminium doors and windows.

TREATMENT

Available dipped

Available painted

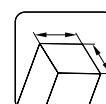

90x90 mm

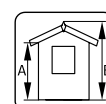

A: 220 cm
B: 315 cm

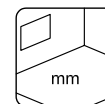

mm

PALMAKO PAVILION ISABELLA 22,2 m²

NEW!

NEW!
ALUMINIUM DOORS
AND WINDOWS



Can be built in reverse!

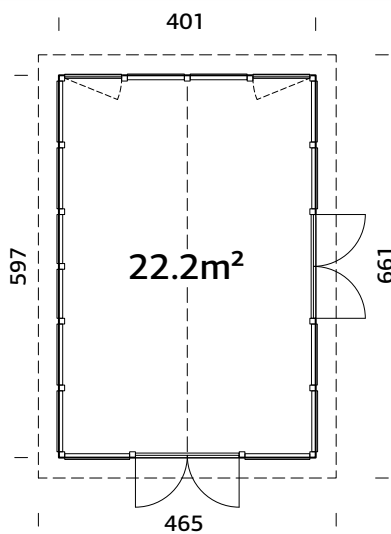

Aluminium doors and windows.

MODEL SPECIFICATIONS

Wall measurements: 401x597 cm

Volume: 57,7 m³

Door/window type: Alu SG

Window glass: Real glass, 4 mm

Door glass: Toughened, 4 mm

Fixed window measurements:

78x153 cm, 114x50 cm

Window opening measurements:

78x153 cm

Door opening measurements:

176x203 cm

Door sill: low, covered with stainless steel

Roof boards: 16 mm

Roof area: 32,6 m²

Roof gradient: 20,0°

Gross ground area: 23,9 m²

OPTIONAL

Roofing felt (underlayer): 5 rolls, SBS roofing material: 5 rolls, shingles: 10 packs, roofing nails, rain gutters.

TREATMENT

Available dipped

Available painted



90x90 mm

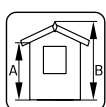

A: 226 cm
B: 315 cm

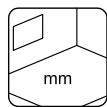

Aluminium window
Single glass, 4 mm



Aluminium door
Single glass, toughened, 4 mm

PALMAKO GLASSHOUSE EMILIA 5,4 m²



Automatically opening window.

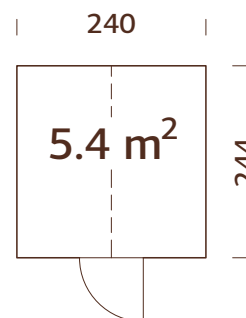

TREATMENT



grey pressure-treated

MODEL SPECIFICATIONS

Wall measurements: 240x244 cm

Volume: 13,0 m³

Glass: Toughened, 4 mm

Roof area: 8,4 m²

Roof gradient: 45°

Gross ground area: 5,8 m²

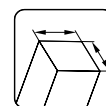

44x95 mm

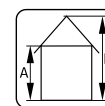

A: 159 cm
B: 286 cm

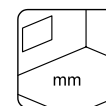

-

PALMAKO GLASSHOUSE EMILIA 8,2 m²



Automatically opening window.

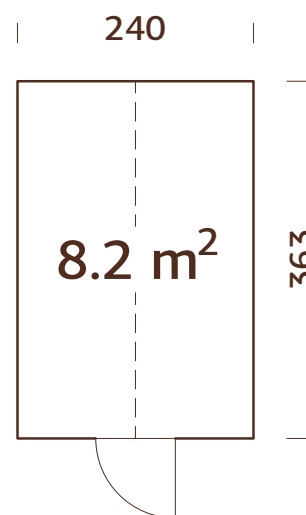

TREATMENT



grey pressure-treated

MODEL SPECIFICATIONS

Wall measurements: 240x363 cm

Volume: 19,4 m³

Glass: Toughened, 4 mm

Roof area: 12,5 m²

Roof gradient: 45°

Gross ground area: 8,7 m²

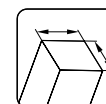

44x95 mm

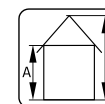

A: 159 cm
B: 286 cm

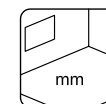

-



Emilia 8,2 m²

PALMAKO GLASSHOUSE EMILIA SHED 4,0 m²

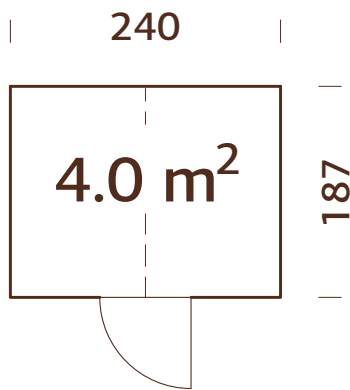

NB! Emilia shed fits only with Emilia 5,4 m² and 8,2 m² models!



TREATMENT



grey pressure-treated

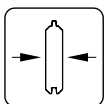

18 mm

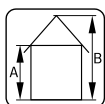

A: 160 cm

B: 286 cm

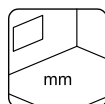

-

MODEL SPECIFICATIONS

Wall measurements: 240x187 cm

Volume: 9,7 m³

Door opening measurements:
68x183 cm

Roof boards: 19 mm

Roof area: 6,5 m²

Roof gradient: 45,0°

Gross ground area: 4,4 m²

OPTIONAL

Roofing felt (underlayer): 1 roll, SBS roofing material: 1 roll, shingles: 3 packs, roofing nails.

PALMAKO GLASSHOUSE EMILIA 13,8 m²



Automatically opening window.

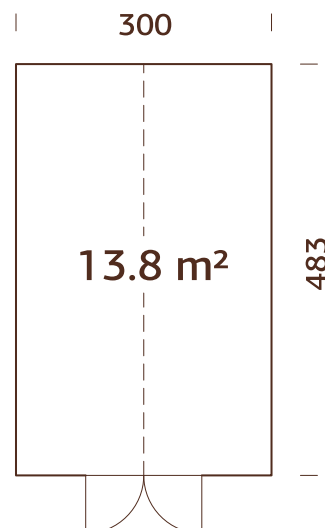

MODEL SPECIFICATIONS

Wall measurements: 300x483 cm

Volume: 32,7 m³

Glass: Toughened, 4 mm

Roof area: 19,1 m²

Roof gradient: 39,0°

Gross ground area: 14,5 m²

TREATMENT



grey pressure-treated

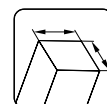

44x95 mm

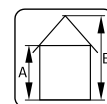

A: 159 cm

B: 288 cm

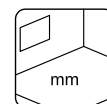

PALMAKO GLASSHOUSE EMILIA 19,1 m²



Automatically opening window.

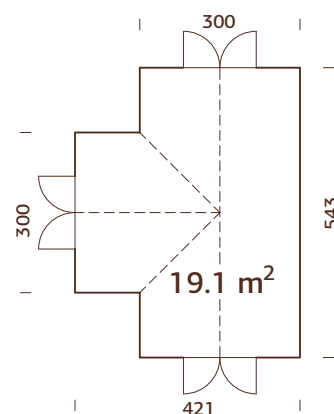

TREATMENT



grey pressure-treated

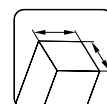

44x95 mm

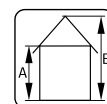

A: 159 cm

B: 288 cm

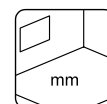

PALMAKO GRILL KOTA EVA 8,7 m²

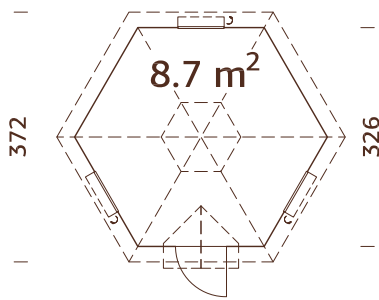

Ready-made roof elements.
Option: Grill with table, smoke extraction hood, chimney and chimney cap.



TREATMENT

Available dipped

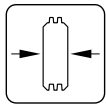

44 mm

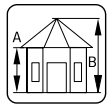

A: 137 cm
B: 314 cm

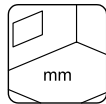

Included,
grates 19 mm

MODEL SPECIFICATIONS

Diameter: 326 cm

Volume: 19,0 m³

Door/window type:

Garden+

Door/window glass:

Double glass, 3-6-3 mm

Window opening

measurements: 59x41 cm

Door opening

measurements:

65x148 cm

Door sill:

covered with stainless steel

Roof boards: 19 mm

Roof area: 18,0 m²

Roof gradient: 45,0°

Gross ground area: 9,2 m²



OPTIONAL

Shingles: 9 packs, roofing nails,
grill with table, additional door and
window.

PALMAKO GRILL KOTA EVA 11,4 m²

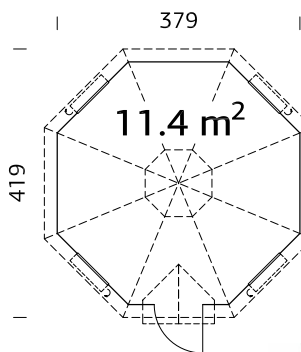

Ready-made roof elements.
Option: Grill with table, smoke extraction hood, chimney and chimney cap.



TREATMENT

Available dipped

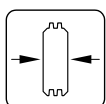

44 mm

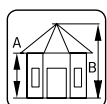

A: 137 cm
B: 346 cm

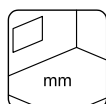

Included,
grates 19 mm

MODEL SPECIFICATIONS

Diameter: 379 cm

Volume: 26,0 m³

Door/window type:

Garden+

Door/window glass:

Double glass, 3-6-3 mm

Window opening

measurements: 59x41 cm

Door opening

measurements:

65x148 cm

Door sill:

covered with stainless steel

Roof boards: 19 mm

Roof area: 22,0 m²

Roof gradient: 45,0°

Gross ground area: 11,9 m²



OPTIONAL

Shingles: 12 packs, roofing nails,
grill with table, additional door and
window.

OPTIONAL PRODUCTS

SEE OPTIONAL PRODUCTS, PAGES 344-368



House	Art. No.	Floor ¹	Roofing felt, rolls	SBS roofing material, rolls	Shingles ² , packs	Roofing nails, 1 kg	EPDM	Rain gutters
Melanie low 7.0 m ²	103712		107210, 2 rolls	107214, 2 rolls		107930	111847	2 x 106630
Melanie 7.0 m ²	103708				6 packs	107930		
Melanie 6.9 m ²	103728				6 packs	107930		
Melanie 9.9 m ²	103732				8 packs	107930		
Melanie 7.0+8.1 m ²	103778				10 packs	2 x 107930		106632 + 106630
Hanna 7.6 m ²	103724				8 packs	107930		
Hanna 14.1 m ²	106185				12 packs	2 x 107930		
Hanna 20.3 m ²	106189				16 packs	2 x 107930		
Veronica 2.67 m ²	103744				7 packs	107930		
Veronica 4.67 m ²	103748				7 packs	107930		
Veronica 4.92 m ²	107374				9 packs	107930		
Veronica 7.92 m ²	107373				9 packs	107930		

¹ Floor boards are pressure-treated and floor joists are treated. ² Shingles are available in different colours - 107180 = Black, 107182 = Red, 107183 = Green, 107181 = Brown. The article number is indicated to untreated items, for treated items ask our sales team.

OPTIONAL PRODUCTS

SEE OPTIONAL PRODUCTS, PAGES 344-368



House	Art. No.	Floor ¹	Roofing felt, rolls	SBS roofing material, rolls	Shingles ² , packs	Roofing nails, 1 kg	EPDM	Rain gutters	Element Lucy 1, solid	Element Lucy 2, glass	Anchor, adjustable post leg	Grill stove with table
Betty 9,0 m ²	103798	103090			8 packs	107930					106608	
Betty 9,9 m ²	103879	103092			9 packs	107930					106608	
Betty 18,0 m ²	105212	103094			14 packs	2 x 107930					106608	
Betty 25,0 m ²	104704	103096			17 packs	2 x 107930					106608	
Julie 10,5 m ²	103760				9 packs	107930						
Lucy 12,2 m ²	103980		107210, 3 rolls	107214, 3 rolls	107930	107930	2 x 111847	106627	102836	102840	106608	
Isabella 10,9 m ²	119341		107210, 3 rolls	107214, 3 rolls	8 packs	107930		106631				
Isabella 14,7 m ²	112126		107210, 4 rolls	107214, 4 rolls	9 packs	107930		106631				
Isabella 22,2 m ²	119345		107210, 5 rolls	107214, 5 rolls	10 packs	107930		106629 + 106630				
Emilia shed 4,0 m ²	109394		107210, 1 roll	107214, 1 roll	3 packs	107930						
Eva 8,7 m ²	104592				9 packs	107930						102789
Eva 11,4 m ²	104596				12 packs	2 x 107930						102789

¹ Floor boards are pressure-treated and floor joists are treated. ² Shingles are available in different colours - 107180 = Black, 107182 = Red, 107183 = Green, 107181 = Brown. The article number is indicated to untreated items, for treated items ask our sales team.



Anette 3,0+1,5 m²



GARDEN SPA

OUTDOOR SPA IN YOUR OWN GARDEN

We are delighted to introduce you our brand new Garden Spa category - a generation of Spa products, which brings a new level of innovation to our range. What could be more enjoyable than having an outdoor spa in your own garden, a relaxing area and a healthy extra space for yourself, your family and friends. With having a sauna in the garden you can easily transform your garden or property into a personal functional garden SPA.

We have in Garden Spa product range many saunas – let us introduce you the barrel saunas called Anita and an oval sauna Anette 3,0+1,5 m². There are five Anita barrel sauna models. The first, Anita 0,9 m²., is the smallest one, a very compact and little space requiring sauna. The larger Anitas are available with a wooden front wall and a glass front wall, accordingly Anita 1,3+0,7 m², Anita 1,3+0,7 m² with glass wall, Anita 1,6+0,7 m² and Anita 1,6+0,7 m² with glass wall.

Electric heater can be ordered as an optional extra – there are HUUM Drop and Narvi NM heaters in our selection. Please see the pages 193-194 for more information.

Please get familiar with the 3D cross-section showing the main features of an oval sauna Anette 3,0+1,5 m².

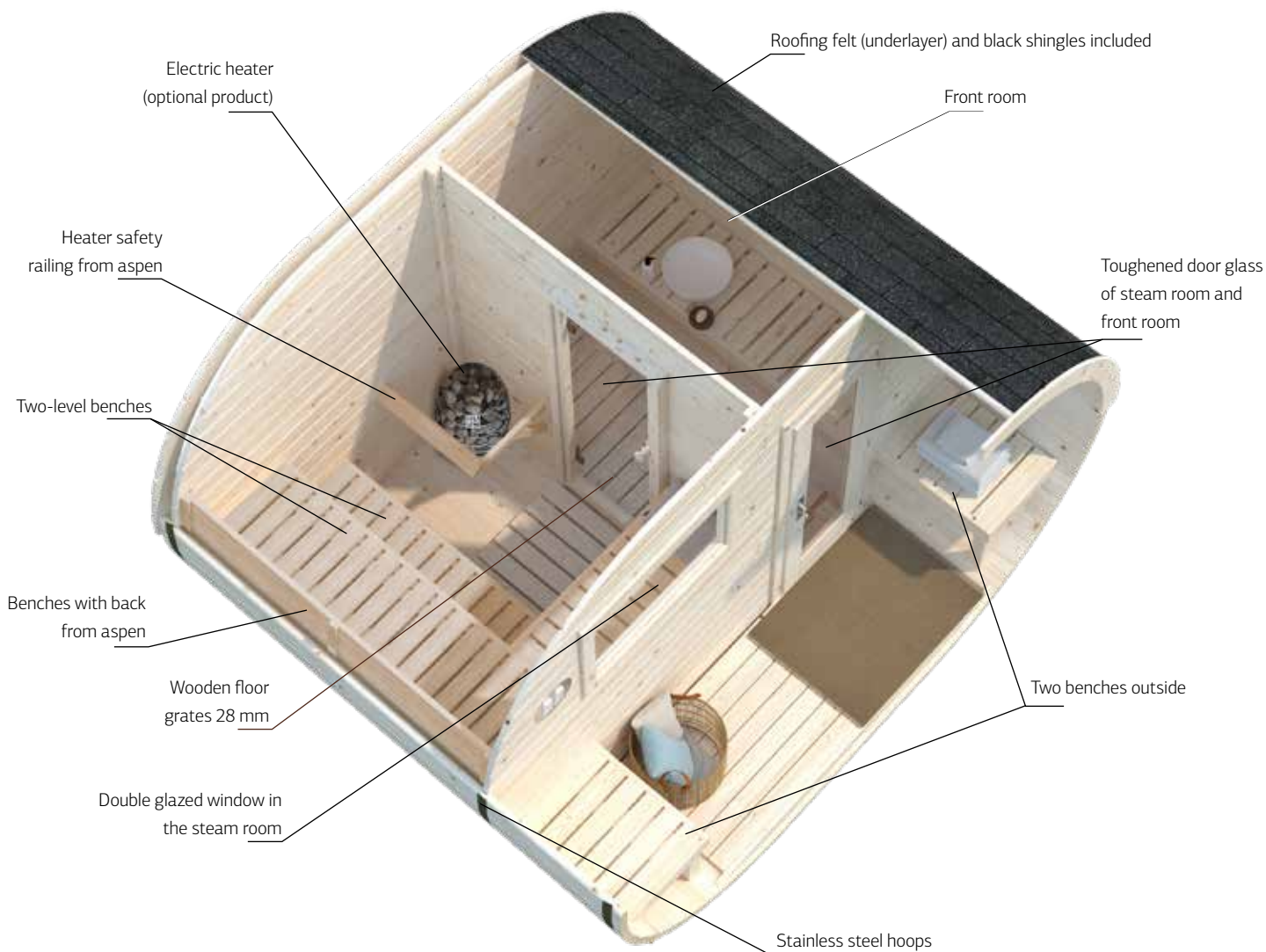



The shape of barrel and oval saunas provide a **good air circulation**, the heat distribution is very even because after hot air rises in the steam room it gently curls down each side of the sauna. Cool air is pulled in the low vent by the vacuum created by hot air rising, which then exhausts out the high vent on the opposite side of the room.

Steam room **benches with backrest** take the pressure off from low back, shoulders and neck and help to ensure the spine in a neutral position. These benches are made of **aspen** which has low thermal conductivity and does not release resin.

The **two-level benches** (in Anita 0,9 m² and Anette 3,0+1,5 m²) allow each person to choose the optimal temperature regime.



Removable **28 mm wooden floor grates** can be easily cleaned, won't let you to slip and feel really good under your bare feet.



Front room (in Anette 3,0+1,5 m²) can be used for many different purposes – you can either wash yourself, store your belongings, change clothes, take a short break or sometimes just hide from bad weather.



Black shingles are included in the set. Shingles protect your sauna from the top and give the final touch in appearance. Anette 3,0+1,5 m² set includes additionally also the roofing felt (underlayer).



Both saunas have **high quality doors and window**. The glass door of the steam room has an 8 mm toughened glass, while the partly glazed outside door has a 4-6-4 mm double toughened glass. The window has a 3-6-3 mm double glass.

Window in the steam room (in Anette 3,0+1,5 m²) lets natural light inside and gives a chance to look outside while enjoying sauna procedures. Anita 1,3+0,7 m² glass wall and Anita 1,6+0,7 m² glass wall models have a glass front wall with 6 mm toughened glass, which lets you enjoy the nice view to your garden.



The cozy outdoor benches offer a nice place to take a short break, breathe fresh air or enjoy some refreshments.



PALMAKO SAUNA
ANITA 0,9 m²



PALMAKO SAUNA
ANITA 1,3+0,7 m²



PALMAKO SAUNA
ANITA 1,3+0,7 m²
WITH GLASS WALL



PALMAKO SAUNA
ANITA 1,6+0,7 m²



PALMAKO SAUNA
ANITA 1,6+0,7 m²
WITH GLASS WALL



PALMAKO SAUNA
ANETTE 3,0+1,5 m²



PALMAKO SAUNA
SANNA 4,1 m²



PALMAKO SAUNA
SANNA 4,1+5,9 m²



PALMAKO SAUNA
SANNA 6,8 m²



PALMAKO SAUNA
SANNA 6,8+5,9 m²



PALMAKO SAUNA
SANNA 11,5 m²



PALMAKO SAUNA
SANNA 12,8 m²
SLIDE / SLIDE PLUS



PALMAKO SAUNA
GRACE 5,3 m²



PALMAKO SAUNA
GRACE 8,2 m²

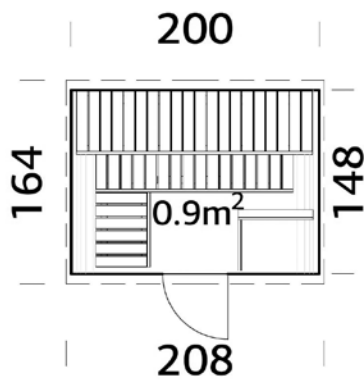

PALMAKO SAUNA
SARAH 3,8+2,1 m²

PALMAKO SAUNA ANITA 0,9 m²under
2,5m**MODEL SPECIFICATIONS****Diameter** 200 cm**Length:** 160 cm**Width:** 200 cm**Vertical walls:** 28 mm**Steam room measurements:**

191x142 cm

Volume: 4,1 m³**Steam room door glass:**

Toughened, 8 mm

Door opening measurements:

50x161 cm

Roof area: 5,0 m²**Capacity:** 3 people**Inside measures of heater****safety railing:** 634x457 mm

Shingles included.

Steam room benches from aspen.

Two-level steam room benches with backrest.

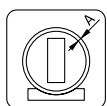
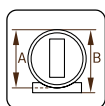
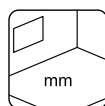
**42 mm****A: 200 cm**
B: 206 cm**Floor grates**
28 mm**OPTIONAL**

Roofing felt (underlayer): 1 roll, SBS roofing material: 1 roll, roofing nails, additional door.

PALMAKO SAUNA ANITA 1,3+0,7 m²

under
2,5m

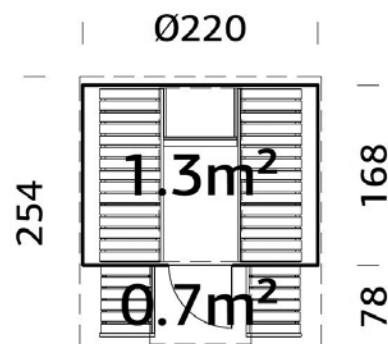
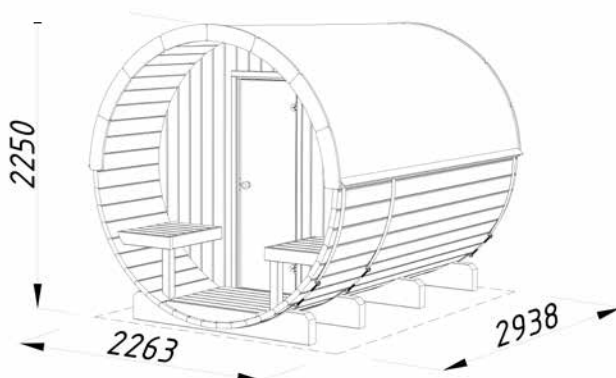

MODEL SPECIFICATIONS

Diameter: 220 cm

Length: 250 cm

Width: 220 cm

Vertical walls: 28 mm

Steam room measurements:

211x162 cm

Volume: 8,4 m³

Steam room door glass:

Toughened, 8 mm

Door opening measurements:

50x161 cm

Roof area: 8,6 m²

Roof overhang: 78 cm

Capacity: 4 people

Inside measures of heater

safety railing: 634x457 mm

Shingles included.

Steam room benches from aspen.

Outdoor benches.

NB! Heater is an optional extra!

OPTIONAL

HUUM Drop electric heater (stones and remote control included), Narvi NM electric heater (stones included), roofing felt (underlayer) 2 rolls, SBS roofing material: 2 rolls, roofing nails, additional door.

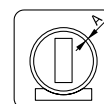

42 mm

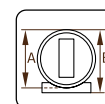

A: 220 cm
B: 225 cm

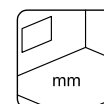

Floor grates
28 mm

under
2,5m

PALMAKO SAUNA ANITA 1,3+0,7 m² WITH GLASS WALL

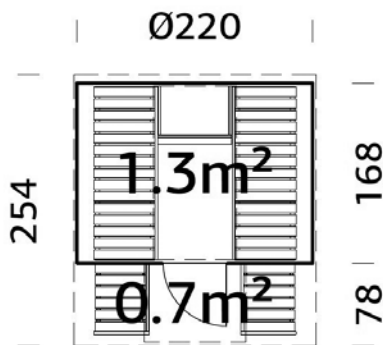
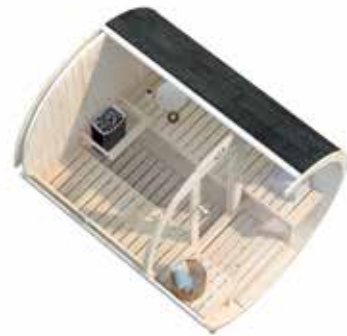

MODEL SPECIFICATIONS

Diameter: 220 cm

Length: 250 cm

Width: 220 cm

Vertical walls: 28 mm

Steam room measurements:

211x162 cm

Volume: 8,4 m³

Steam room door glass:

Toughened, 8 mm

Front wall glass:

Toughened, 6 mm

Door opening measurements:

50x161 cm

Roof area: 8,6 m²

Roof overhang: 78 cm

Capacity: 4 people

Inside measures of heater safety

railing: 634x457 mm

Shingles included.

Steam room benches from aspen.

Glass front wall.

Outdoor benches.

NB! Heater is an optional extra!

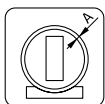

42 mm

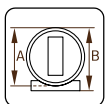

A: 220 cm
B: 225 cm

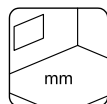

Floor grates
28 mm

OPTIONAL

HUUM Drop electric heater (stones and remote control included), Narvi NM electric heater (stones included), roofing felt (underlayer) 2 rolls, SBS roofing material: 2 rolls, roofing nails, additional door.

PALMAKO SAUNA ANITA 1,6+0,7 m²

under
2,5m

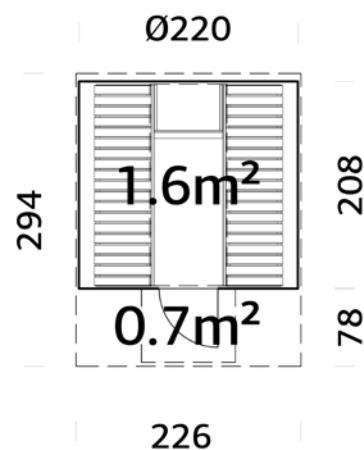
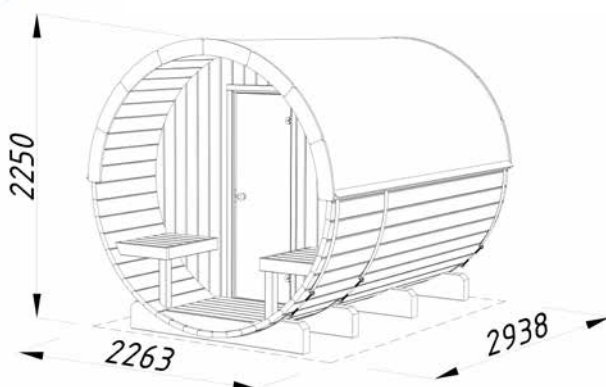

MODEL SPECIFICATIONS

Diameter: 220 cm

Length: 290 cm

Width: 220 cm

Vertical walls: 28 mm

Steam room measurements:

211x202 cm

Volume: 9,8 m³

Steam room door glass:

Toughened, 8 mm

Front wall glass: Toughened, 6 mm

Door opening measurements:

50x161 cm

Roof area: 10,4 m²

Roof overhang: 78 cm

Capacity: 6 people

Inside measures of heater safety

railing: 634x457 mm

Shingles included.

Steam room benches from aspen.

Outdoor benches.

NB! Heater is an optional extra!

OPTIONAL

HUUM Drop electric heater (stones and remote control included), Narvi NM electric heater (stones included), roofing felt (underlayer): 2 rolls, SBS roofing material: 2 rolls, roofing nails, additional door.

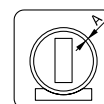

42 mm

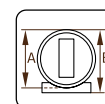

A: 220 cm
B: 225 cm

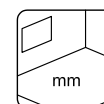

Floor grates
28 mm

under
2,5m

PALMAKO SAUNA ANITA 1,6+0,7 m² WITH GLASS WALL

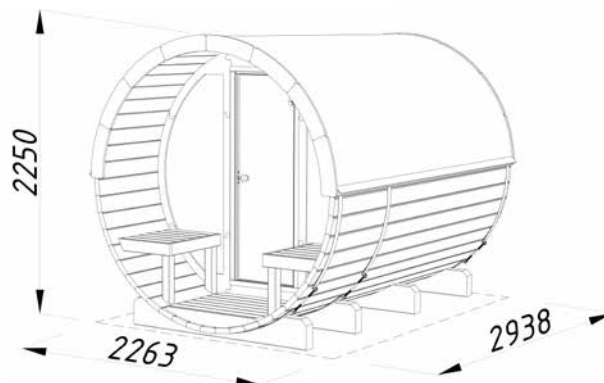
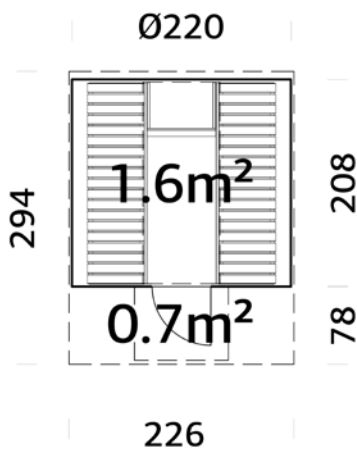

MODEL SPECIFICATIONS

Diameter: 220 cm

Length: 290 cm

Width: 220 cm

Vertical walls: 28 mm

Steam room measurements:

211x202 cm

Volume: 9,8 m³

Steam room door glass:

Toughened, 8 mm

Front wall glass: Toughened, 6 mm

Door opening measurements:

50x161 cm

Roof area: 10,4 m²

Roof overhang: 78 cm

Capacity: 6 people

Inside measures of heater safety

railing: 634x457 mm

Shingles included.

Steam room benches from aspen.

Glass front wall.

Outdoor benches.

NB! Heater is an optional extra!

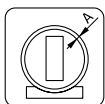

42 mm

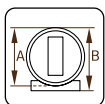

A: 220 cm
B: 225 cm

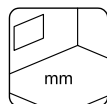

Floor grates
28 mm

OPTIONAL

HUUM Drop electric heater (stones and remote control included), Narvi NM electric heater (stones included), roofing felt (underlayer): 2 rolls, SBS roofing material: 2 rolls, roofing nails, additional door.

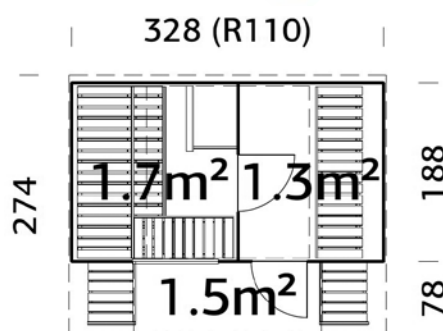
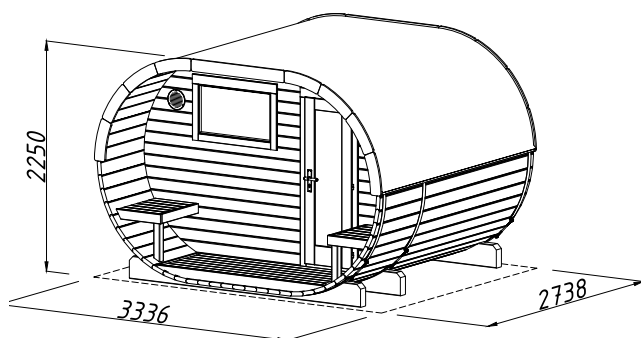
PALMAKO SAUNA ANETTE 3,0+1,5 m²under
2,5m**MODEL SPECIFICATIONS****Length:** 270 cm**Width:** 328 cm**Vertical walls:** 28 mm**Steam room measurements:**

169x182 cm

Front room measurements:

147x182 cm

Volume: 15,0 m³**Door/window type:** Garden+**Steam room door glass:**

Toughened, 8 mm

Front room door glass:

Toughened, 4-6-4 mm

Window glass:

Double glass, 3-6-3 mm

Door opening measurements:

49x159, 50x161 cm

Fixed window measurements:

80x45 cm

Roof area: 12,1 m²**Roof overhang:** 78 cm**Capacity:** 4 people**Inside measures of heater****safety railing:** 634x457 mm

334

Roofing felt (underlayer) and shingles included.

Steam room benches from aspen.

Two-level steam room benches with backrest.

Front room.

Window in the steam room.

Outdoor benches.

NB! Heater is an optional extra!

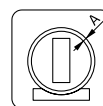

42 mm

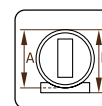
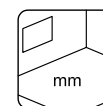
A: 220 cm
B: 225 cmFloor grates
28 mm**OPTIONAL**

HUUM Drop electric heater (stones and remote control included), Narvi NM electric heater (stones included), SBS roofing material: 2 rolls, roofing nails, additional door and window.

PALMAKO LOG SAUNAS

Garden Spa product range includes different looking saunas, everyone should find a sauna they are looking for. In addition to the barrel and oval saunas one can relax and enjoy the sauna rituals also in our log saunas called Sanna.



Sanna steam room ceilings are provided with the 30 mm **insulation** and covered with the 16 mm **wooden cladding**.



Steam room benches are made of **aspen** which has low thermal conductivity and does not release resin. The **two-level benches** allow each person to choose the optimal temperature regime.



The **cozy outdoor bench** outside offers a nice place to cool down after the session in steam room and take a short break while the **Louvre panel** provides privacy.



Sanna saunas have **high quality doors and windows**. The glass door of the steam room has an 8 mm toughened glass, while the partly glazed outside door has a 4-9-4 mm double toughened glass. All windows have a 4-9-4 double toughened glass. Most of Sanna saunas have **window in the steam room and front room**, which allows natural light in and lets enjoy the view outside.

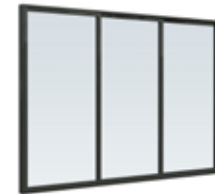

The frame colour of Sanna 12,8 m² **sliding doors** is dark grey RAL7016. Sliding door Slide has 4 mm toughened glass, sliding door Slide Plus 4-16-4 mm double toughened glass.



Sanna 6,8+5,9 m²

PALMAKO SAUNA SANNA 4,1 m²under
2,5m

Can be built in reverse!

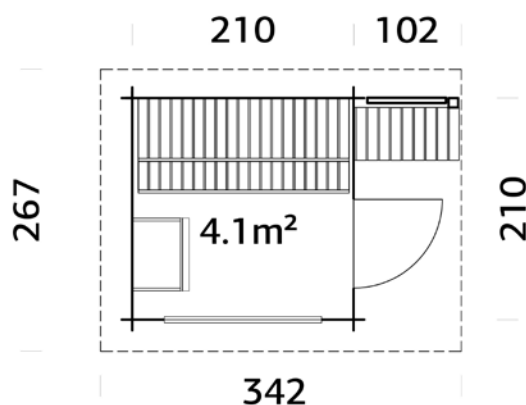
**MODEL SPECIFICATIONS****Log measurements:** 230+102x230 cm**Steam room measurements:** 201x201 cm**Volume:** 9,2 m³**Door/window type:** Summer**Door/window glass:**

Toughened, 4-9-4 mm

Fixed window measurements: 132x81 cm**Door opening measurements:** 67x183 cm**Steam room ceiling insulation:** 30 mm**Steam room ceiling boards:** 16 mm**Door sill:** low, covered with stainless steel**Roof boards:** 19 mm**Roof area:** 8,9 m²**Roof gradient:** 6,3°**Capacity:** 3 people**Gross ground area:** 4,4 m²**Inside measures of heater safety railing:**

634x457 mm

Steam room benches from aspen.

Two-level steam room benches with backrest.

Window in the steam room.

Outdoor bench under roof overhang.

Louvre panel outside for more privacy.

NB! Heater is an optional extra!

OPTIONAL

HUUM Drop electric heater (stones and remote control included), Narvi NM electric heater (stones included), roofing felt (underlayer): 2 rolls, SBS roofing material: 2 rolls, roofing nails, EPDM, rain gutters, additional door and window.

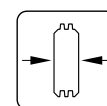
TREATMENTAvailable painted 

44 mm

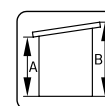
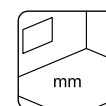
A: 217 cm
B: 249 cmIncluded
28 mm

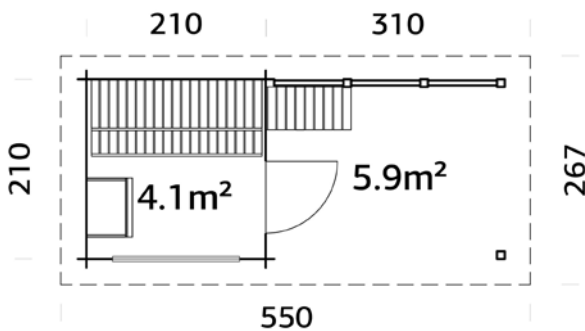
PALMAKO SAUNA SANNA 4,1+5,9 m²under
2,5m

Can be built in reverse!

Steam room benches from aspen.

Two-level steam room benches with backrest.

Window in the steam room.

Outdoor bench under roof overhang.

Louvre panel outside for more privacy.

NB! Heater is an optional extra!

MODEL SPECIFICATIONS**Log measurements:** 230+310x230 cm**Steam room measurements:** 201x201 cm**Volume:** 9,2+13,4 m³**Door/window type:** Summer**Door/window glass:**

Toughened, 4-9-4 mm

Fixed window measurements: 132x81 cm**Door opening measurements:** 67x183 cm**Steam room ceiling insulation:** 30 mm**Steam room ceiling boards:** 16 mm**Door sill:** low, covered with stainless steel**Roof boards:** 19 mm**Roof area:** 14,4 m²**Roof gradient:** 6,3°**Capacity:** 3 people**Gross ground area:** 10,5 m²**Inside measures of heater safety railing:**

634x457 mm

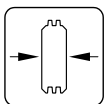
TREATMENTAvailable painted 

44 mm

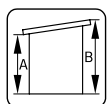
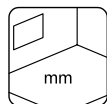
A: 217 cm
B: 249 cmIncluded
28 mm**OPTIONAL**

HUUM Drop electric heater (stones and remote control included), Narvi NM electric heater (stones included), roofing felt (underlayer): 4 rolls, SBS roofing material: 4 rolls, roofing nails, EPDM, rain gutters, additional door and window.

PALMAKO SAUNA SANNA 6,8 m²under
2,5m

Can be built in reverse!

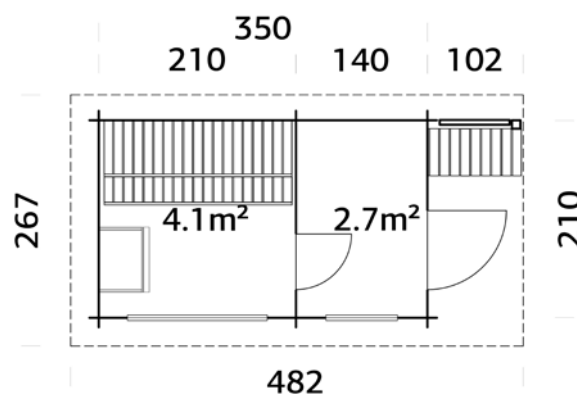
**MODEL SPECIFICATIONS****Log measurements:** 370+102x230 cm**Front room measurements:** 201x135 cm**Steam room measurements:**
201x201 cm**Steam room door glass:**
Toughened, 8 mm**Volume:** 15,7 m³**Door/window type:** Summer**Door/window glass:**
Toughened, 4-9-4 mm**Fixed window measurements:**
60x149 cm, 132x81 cm**Door opening measurements:**

67x183 cm, 59x179 cm

Steam room ceiling insulation: 30 mm**Steam room ceiling boards:** 16 mm**Door sill:** low, covered with stainless steel**Roof boards:** 19 mm**Roof area:** 12,6 m²**Roof gradient:** 6,3°**Capacity:** 3 people**Gross ground area:** 7,4 m²**Inside measures of heater safety railing:**
634x457 mm

Steam room benches from aspen.

Two-level steam room benches with backrest.

Front room.

Window in the steam room.

Outdoor bench under roof overhang.

Louvre panel outside for more privacy.

NB! Heater is an optional extra!

OPTIONAL

HUUM Drop electric heater (stones and remote control included), Narvi NM electric heater (stones included), roofing felt (underlayer): 2 rolls, SBS roofing material: 2 rolls, roofing nails, EPDM, rain gutters, additional door and window.

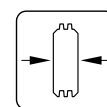

44 mm

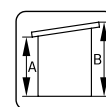
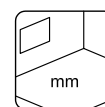
A: 217 cm
B: 249 cmIncluded
28 mm

PALMAKO SAUNA SANNA 6,8+5,9 m²under
2,5m

Can be built in reverse!

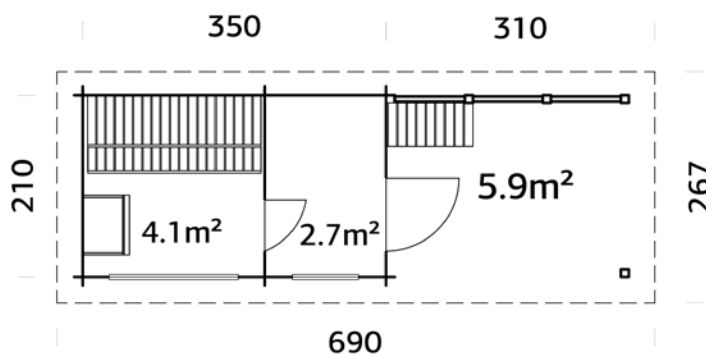

Steam room benches from aspen.

Two-level steam room benches with backrest.

Front room.

Window in the steam room.

Outdoor bench under roof overhang.

Louvre panel outside for more privacy.

NB! Heater is an optional extra!

MODEL SPECIFICATIONS**Log measurements:** 370+310x230**Front room measurements:** 201x135 cm**Steam room measurements:** 201x201 cm**Steam room door glass:**

Toughened, 8 mm

Volume: 15,7+13,4 m³**Door/window type:** Summer**Door/window glass:**

Toughened, 4-9-4 mm

Fixed window measurements:

60x149 cm, 132x81 cm

Door opening measurements:

67x183 cm, 59x179 cm

Steam room ceiling insulation: 30 mm**Steam room ceiling boards:** 16 mm**Door sill:** low, covered with stainless steel**Roof boards:** 19 mm**Roof area:** 18,4 m²**Roof gradient:** 6,3°**Capacity:** 3 people**Gross ground area:** 13,5 m²**Inside measures of heater safety railing:**

634x457 mm

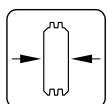

44 mm

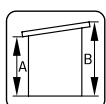
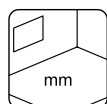
**A:** 217 cm
B: 249 cm**Included**
28 mm**OPTIONAL**

HUUM Drop electric heater (stones and remote control included), Narvi NM electric heater (stones included), roofing felt (underlayer): 4 rolls, SBS roofing material: 4 rolls, roofing nails, EPDM, rain gutters, additional door and window.

PALMAKO SAUNA SANNA 11,5 m²

NEW!



Can be built in reverse!

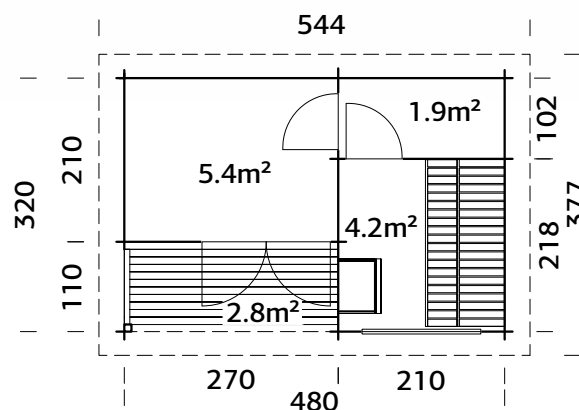

MODEL SPECIFICATIONS

Log measurements: 500x340 cm**Front room measurements:** 202x266 cm**Steam room measurements:**
211x201 cm**Volume:** 27,0 m³**Door/window type:** Summer**Steam room door glass:**

Toughened, 8 mm

Window glass/front room door glass:

Double toughened, 4-9-4 mm

Fixed window measurements:

132x81cm

Door opening measurements:

59x179 cm, 144x183 cm

Steam room ceiling insulation: 30 mm**Steam room ceiling boards:** 16 mm**Door sill:** low, covered with stainless steel**Roof boards:** 19 mm**Roof area:** 20,3 m²**Roof gradient:** 6,3°**Capacity:** 3 people**Gross ground area:** 15,4 m²**Inside measures of heater safety railing:**

634x457 mm

Steam room benches from aspen.

Two-level steam room benches with backrest.

Window in the steam room.

NB! Heater is an optional extra!

OPTIONAL

HUUM Drop electric heater (stones and remote control included), Narvi NM electric heater (stones included), roofing felt (underlayer): 5 rolls, SBS roofing material: 5 rolls, roofing nails, EPDM, rain gutters, additional door and window.

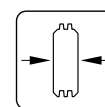

44 mm

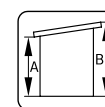
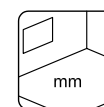
A: 217 cm
B: 261 cmIncluded
28 mm

under
2,5m

PALMAKO SAUNA SANNA 12,8 m²

SLIDE / SLIDE PLUS

172-195



Can be built in reverse!

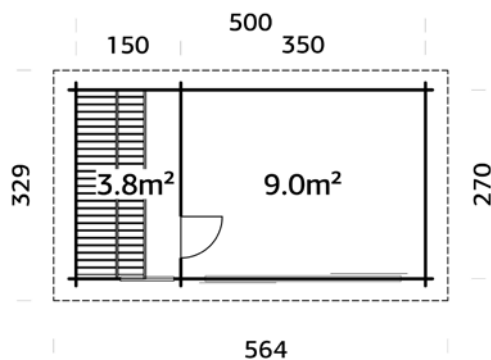

MODEL SPECIFICATIONS

Log measurements 520x290 cm

Steam room measurements:
261x143cm

Front room measurements:
343x261 cm

Volume: 28,6 m³

Steam room door glass:
Toughened, 8 mm

Fixed window opening measurements: 60x149 cm

Door opening measurements:
59x179 cm

Sliding door opening measurements (three sheets)
176x187 cm (Slide), 172x185 cm (Slide Plus)

Steam room ceiling insulation:
30 mm

Steam room ceiling boards:
16 mm

Door sill: low, covered with stainless steel

Roof boards: 19 mm

Roof area: 18,3 m²

Roof gradient: 4,9°

Capacity: 3 people

Gross ground area: 13,5 m²

Inside measures of heater safety railing: 634x457 mm

Sliding doors included.

Steam room benches from aspen.

Two-level steam room benches with backrest.

Front room.

Window in the steam room.

NB! Heater is an optional extra!

OPTIONAL

HUUM Drop electric heater (stones and remote control included), Narvi NM electric heater (stones included), roofing felt (underlayer): 4 rolls, SBS roofing material: 4 rolls, roofing nails, EPDM, rain gutters, additional window.

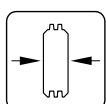

44 mm

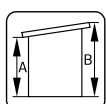

A: 211 cm
B: 239 cm

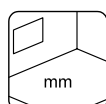

Included
28 mm



Slide
Single glass, toughened, 4 mm



Slide Plus
Double glass, toughened, 4-16-4 mm

PALMAKO SAUNA GRACE 5,3 m²

under
2,5m

NEW!



MODEL SPECIFICATIONS

Wall measurements: 250x230 cm

Steam room measurements:

240x218 cm

Volume: 12,1 m³

Door/window type: Alu DG

Door/window glass:

Double toughened, 4-16-4 mm

Fixed window measurements:

70x168 cm

Door opening measurements:

70x191 cm

Steam room ceiling insulation: 30 mm

Steam room ceiling boards: 16 mm

Roof boards: 19 mm

Roof area: 5,8 m²

Roof gradient: 2,0°

Capacity: 4 people

Gross ground area: 5,7 m²

Inside measures of heater safety railing:

634x457 mm

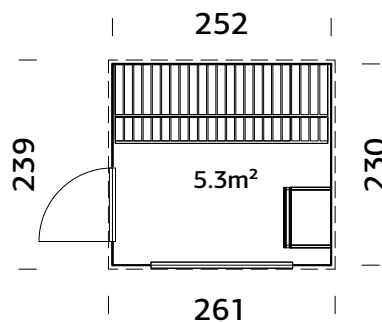

OPTIONAL

HUUM Drop electric heater (stones and remote control included), Narvi NM electric heater (stones included), roofing felt (underlayer): 1 roll, SBS roofing material: 1 roll, roofing nails, EPDM, rain gutters.

Aluminium doors and windows.

Smokey glass.

Steam room benches from aspen.

Two-level steam room benches with backrest.

Large window in the steam room.

NB! Heater is an optional extra!

Metal roof edge included.



Aluminium window

Double glass, toughened, 4-16-4 mm



Aluminium door

Double glass, toughened, 4-16-4 mm

TREATMENT

Available painted

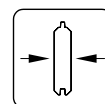

56 mm

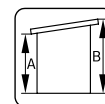

A: 245 cm
B: 250 cm

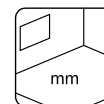

Included
28 mm

PALMAKO SAUNA GRACE 8,2 m²under
2,5m

NEW!

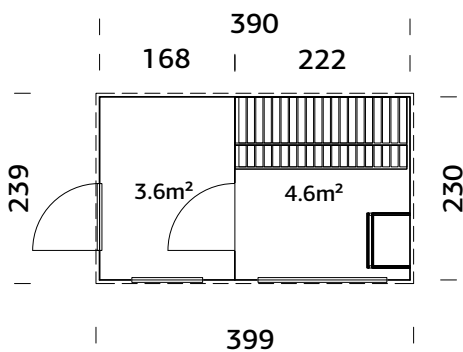

MODEL SPECIFICATIONS

Wall measurements: 390x230 cm**Front room measurements:** 162x218 cm**Steam room measurements:** 210x218 cm**Volume:** 17,7 m³**Door/window type:** Alu DG**Steam room door glass:**

Toughened, 8 mm

Front room door glass:

Double toughened, 4-16-4 mm

Window glass:

Double toughened, 4-16-4 mm

Fixed window measurements:

80x42 cm, 70x168 cm

Door opening measurements:

59x179 cm, 70x191 cm

Steam room ceiling insulation: 30 mm**Steam room ceiling boards:** 16 mm**Roof boards:** 19 mm**Roof area:** 9,0 m²**Roof gradient:** 2,0°**Capacity:** 3 people**Gross ground area:** 9,0 m²**Inside measures of heater safety railing:**

634x457 mm

Aluminium doors and windows.

Smokey glass.

Steam room benches from aspen.

Two-level steam room benches with backrest.

Large window in the steam room.

NB! Heater is an optional extra!

Metal roof edge included.

OPTIONAL

HUUM Drop electric heater (stones and remote control included), Narvi NM electric heater (stones included), roofing felt (underlayer): 2 rolls, SBS roofing material: 2 rolls, roofing nails, EPDM, rain gutters.

TREATMENT

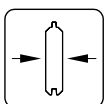
Available painted 

56 mm

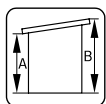
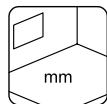
A: 245 cm
B: 250 cmIncluded
28 mm

Aluminium window

Double glass, toughened, 4-16-4 mm



Aluminium door

Double glass, toughened, 4-16-4 mm

PALMAKO SAUNA SARAH 3,8+2,1 m²

under
2,5m

NEW!



MODEL SPECIFICATIONS

Wall measurements: 322x222 cm

Volume: 8,5 m³

Door/window type: Summer

Window glass:

Double toughened, 4-16-4 mm

Door glass:

Double toughened, 4-9-4 mm

Fixed window measurements:

84x199 cm

Door opening measurements:

67x183 cm

Steam room ceiling insulation: 30 mm

Steam room ceiling boards: 16 mm

Door sill: low, covered with stainless steel

Roof boards: 16 mm

Roof area: 6,7 m²

Roof gradient: 1,2°

Capacity: 3 people

Gross ground area: 7,1 m²

Inside measures of heater safety railing:

634x457 mm

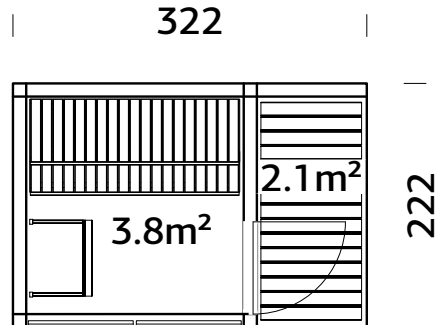

OPTIONAL

HUUM Drop electric heater (stones and remote control included), Narvi NM electric heater (stones included), roofing felt (underlayer): 2 rolls, SBS roofing material: 2 rolls, roofing nails, EPDM, rain gutters.

Aluminium windows.

Smokey glass.

Steam room benches from aspen.

Two-level steam room benches with backrest.

Window in the steam room.

NB! Heater is an optional extra!

Metal roof edge included.



Aluminium window
Double glass, toughened, 4-16-4 mm

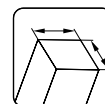

120x120
mm

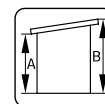

A: 222 cm
B: 237 cm

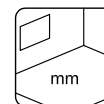

Included
28 mm

A HEATER IS THE HEART OF YOUR SAUNA

A heater is like the heart of a sauna, without the heater there will be undoubtedly no joy of being in a sauna. Although both wood-burning and electric heaters have their advantages and drawbacks, eventually, the choice of the heater is a matter of personal preference. Our saunas are developed for heating with electric heaters, which we offer as optional products. Electric heaters heat up the sauna fast, allow the users to have control over the temperature and change it easily. Please keep in mind to use a licensed electrician to complete the installation of an electric heater.

There are two heaters in our selection – HUUM Drop and Narvi NM, both 6 kW. Please get familiar with the descriptions and specifications so you can make the right decision when choosing the one for your sauna. For further information please contact the salesteam.

Narvi NM electrical heater 6 kW

Black painted, stainless steel

2-year warranty

Measurements: 580 x 430 x 300 mm (height x width x depth)

Safety distance: sides 50 mm, front 80 mm, top 1150 mm, floor 120 mm

The set includes

- electric sauna heater
- heater stones (two boxes, 40 kg)
- installation brackets and connection wiring (different wires inside the heater)

The wire from heater to plug is not included in the set. The heater has the readiness for this cable – the holes in the heater where to put the wire ends from the plug.



Power

Fuse	3 x 10 A
Supply voltage 3-phase	400 V 3N
Cable	5 x 1,5 (N x mm ²)

In the case of a 230 1N connection, an analogous connection is made to the 3-phase. The heating circuits must be done before the circuit breaker.

All of the electrical connections must be done by a certified professional.



HUUM Drop electrical heater 6 kW

Stainless steel

5-year warranty

Measurements: 590 x 390 x 335 mm (height x width x depth)

Safety distance: sides and front 120 mm

The set includes

- electric sauna heater
- heater stones (four boxes, 60 kg)
- built-in electronic control (UKU Local controller)
- wall mount
- 5+5 m cable for temperature and door sensor
- 3 m cable for main module and user interface
- Screws for fastening the user interface and temperature sensor



Power

Fuse	3 x 10 A
Supply voltage 3-phase	400 V 3N
Cable	5 x 1,5 (N x mm ²)

In the case of a 230 1N connection, an analogous connection is made to the 3-phase. The heating circuits must be done before the circuit breaker.

All of the electrical connections must be done by a certified professional.



UKU Local controller

Temperatures: 40-110°C

Supply voltage: 400 V 3N; 230 V 1N

Heating period: 3h, 8h, 12h

Connectable to lights/ventilation and steamer

Temperature sensor and overheating protection

Door sensor

Child safety lock

Timer

The set includes

Control console (105 x 55 x 22 mm)

Control console cable (3 m; 4 x 0,34 mm²)

Main module (142 x 90 x 58 mm)

Temperature sensor

Door sensor

Temperature/door sensor cable (5 + 5m; 2 x 0,22 mm²)

OPTIONAL PRODUCTS

SEE OPTIONAL PRODUCTS, PAGES 344-368

Sauna	Art. No.	Roofing felt, rolls	SBS roofing material, rolls	Roofing material, Roofing nails, 1 kg	EPDM	Rain gutters	HUUM Drop sauna heater	Narvi NIM sauna heater
Anita 0,9 m ²	110343	107210, 1 rolls	107214, 1 rolls	107930				
Anita 1,3+0,7 m ²	110070	107210, 2 rolls	107214, 2 rolls	107930			110119	110115
Anita 1,3+0,7 m ² with glass wall	111005	107210, 2 rolls	107214, 2 rolls	107930			110119	110115
Anita 1,6+0,7 m ²	111003	107210, 2 rolls	107214, 2 rolls	107930			110119	110115
Anita 1,6+0,7 m ² with glass wall	111004	107210, 2 rolls	107214, 2 rolls	107930			110119	110115
Anette 3,0+1,5 m ²	110071	107210, 2 rolls	107214, 2 rolls	107930			110119	110115
Sanna 4,1 m ²	110741	107210, 2 rolls	107214, 2 rolls	107930	111847	106627	110119	110115
Sanna 4,1+5,9 m ²	110526	107210, 4 rolls	107214, 4 rolls	107930	2 x 111847	106628	110119	110115
Sanna 6,8 m ²	111001	107210, 2 rolls	107214, 2 rolls	107930	2x 111847	107375	110119	110115
Sanna 6,8+5,9 m ²	111002	107210, 4 rolls	107214, 4 rolls	107930	2x 111847	106626 + 106627	110119	110115
Sanna 11,5 m ²	119349	107210, 5 rolls	107214, 5 rolls	107930	2 x 111847	106628	110119	110115
Sanna 12,8 m ² Slide	111000	107210, 4 rolls	107214, 4 rolls	107930	2 x 111847	106628	110119	110115
Sanna 12,8 m ² Slide Plus	111239	107210, 4 rolls	107214, 4 rolls	107930	2 x 111847	106628	110119	110115
Grace Sauna 5,3 m ²	119360	107210, 1 roll	107214, 1 roll	107930	111847	106626	110119	110115
Grace Sauna 8,2 m ²	112125	107210, 2 rolls	107214, 2 rolls	107930	111847	106627	110119	110115
Sarah 3,8+2,1 m ²	120033	107210, 2 rolls	107214, 2 rolls	107930	111847	106627	110119	110115



Bianca 16,6 m² Set 108



CONNECT

PALMAKO CONNECT – SPACIOUS BIANCA AND LENNA PAVILIONS

Palmako Connect product series is a brand new concept of different looking spacious pavilion sets. All these sets are an outcome of combining different Palmako Connect components. If you have a specific vision in your head how the building should look like, all Palmako Connect components can be combined with each other to create your dream. In case you do not know which building you wish for and want to see which sets there are in our range to choose from, please get an overview of our sets starting from pages 204 and 230.

Palmako Connect product sets are with a pyramid gable and a pent roof, we call them accordingly **Bianca** and **Lenna**. All the sets are available in both roof types.



Palmako Connect Bianca 24,9 m² Set 211 Slide



Palmako Connect Lenna 24,9 m² Set 411 Slide

Complete your Bianca or Lenna set with our optional products

Bianca 16,6 m² Set 205 basic model

BEFORE

Rain gutters

Shingles

Roofing nails

Floor (outdoor)

Floor (indoor)

Bianca 16,6 m² Set 205 with optional products

AFTER

In addition to the natural, untreated wood Palmako Connect products can be ordered in different dip treatments:



natural, untreated wood



brown dip



grey dip



clear white dip

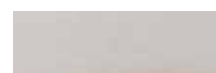

white + white
(RAL9016 + RAL9016)

The overview of Palmako Connect pages

Palmako Connect product series has got a lot of main products, components and product sets, for better understanding of this section let us introduce you the structure of these pages.

Palmako Connect introduction

p. 198-199

A summary of our exciting new product concept which has so many opportunities and possibilities to enrich your garden and improve the quality of your life.

Overview of main products and components

p. 200-203

Product information and visuals of Bianca and Lenna roofs with the internal area of 8,3 m², 16,6 m² and 24,9 m², and components that can be fit and combined with each other (Bianca and Lenna extra roof, full wall, Louvre wall, wall with hatch, half-wall corner, fence, apex, sliding doors, floors).

Bianca Sets

p. 204-229

Gable roof pavilions, many different looking sets to choose from, starting from airy pergolas and finishing up with the functional large buildings with sliding doors.



Lenna Sets

p. 230-255

Pent roof pavilions, lots of designs created in the interest of your garden to find the building that suits you best. Take a look at the smaller pavilions or surprise yourself with our bright and large cabins with elegant sliding doors.



CONNECT



PALMAKO CONNECT
BIANCA 8,3 m²



PALMAKO CONNECT
BIANCA 16,6 m²



PALMAKO CONNECT
BIANCA 24,9 m²



PALMAKO CONNECT
LENNA 8,3 m²



PALMAKO CONNECT
LENNA 16,6 m²



PALMAKO CONNECT
LENNA 24,9 m²



PALMAKO CONNECT BIANCA
EXTRA ROOF WITH TWO
POSTS 8,3 m²



PALMAKO CONNECT LENNA
EXTRA ROOF WITH TWO
POSTS 8,3 m²



PALMAKO CONNECT
FULL WALL



PALMAKO CONNECT
LOUVRE WALL



PALMAKO CONNECT
WALL WITH HATCH



PALMAKO CONNECT
HALF-WALL CORNER



PALMAKO CONNECT
FENCE



PALMAKO CONNECT
BIANCA APEX



PALMAKO CONNECT
FLOOR (INDOOR)



PALMAKO CONNECT
FLOOR (OUTDOOR)

PALMAKO BIANCA EXTRA ROOF WITH TWO POSTS 8,3 m²

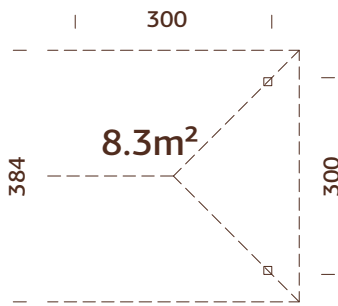

Strong posts from laminated wood.

TREATMENT

- Available dipped
- Available painted

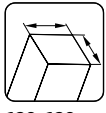

120x120 mm

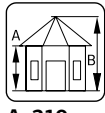

A: 210 cm
B: 319 cm

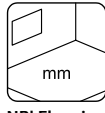

NB! Floor is an optional extra! 28 mm

MODEL SPECIFICATIONS

Measurements: 300x300 cm
Gross ground area: 8,6 m²
Roof boards: 19 mm

Roof area: 26,5 m²
Roof gradient: 30,0°

OPTIONAL

Floor (outdoor/as terrace), floor (indoor), roofing felt (underlayer): 3 rolls, shingles: 6 packs, roofing nails, rain gutters.

PALMAKO LENNA EXTRA ROOF WITH TWO POSTS 8,3 m²

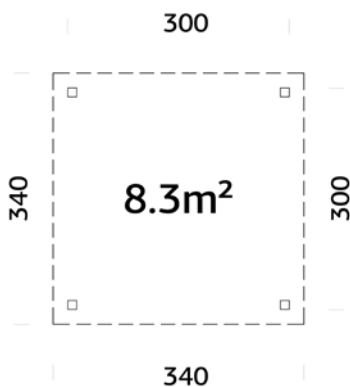

Strong posts from laminated wood.

TREATMENT

- Available dipped
- Available painted

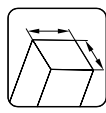

120x120 mm

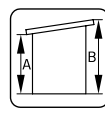

A: 210 cm
B: 245 cm

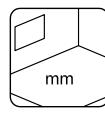

NB! Floor is an optional extra! 28 mm

MODEL SPECIFICATIONS

Measurements: 300x300 cm
Gross ground area: 8,6 m²
Roof boards: 19 mm

Roof area: 10,9 m²
Roof gradient: 3,0°

OPTIONAL

Floor (outdoor/as terrace), floor (indoor), roofing felt (underlayer): 2 rolls, SBS roofing material: 2 rolls, roofing nails, EPDM, rain gutters.

PALMAKO CONNECT FULL WALL

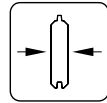

MODEL SPECIFICATIONS

Measurements, width x height: 276x210 cm
Depth: 7 cm

28 mm

TREATMENT

- Available dipped
- Available painted

PALMAKO CONNECT LOUVRE WALL

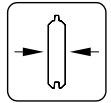

MODEL SPECIFICATIONS

Measurements, width x height: 276x210 cm
Depth: 6 cm

28 mm

TREATMENT

- Available dipped
- Available painted

PALMAKO CONNECT WALL WITH HATCH

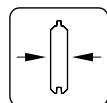

MODEL SPECIFICATIONS

Measurements, width x height: 276x210 cm
Depth: 7 cm

28 mm

TREATMENT

- Available dipped
- Available painted

PALMAKO CONNECT HALF-WALL CORNER

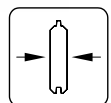

MODEL SPECIFICATIONS

Measurements, width x height: 300x111 cm
Depth: 166 cm

28 mm

TREATMENT

- Available dipped
- Available painted

**PALMAKO CONNECT
FENCE**



MODEL SPECIFICATIONS

Measurements, width x height: 276x80 cm
Depth: 9 cm

TREATMENT

- Available dipped
- Available painted

**PALMAKO BIANCA
APEX**



MODEL SPECIFICATIONS

Measurements, width x height: 278x94 cm
Depth: 6 cm

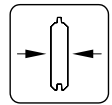

28 mm

TREATMENT

- Available dipped
- Available painted

**PALMAKO CONNECT
FLOOR (INDOOR) 8,3 m²**



TREATMENT

- Available dipped
- Available painted

**PALMAKO CONNECT
FLOOR (OUTDOOR) 8,3 m²**



TREATMENT

-  brown pressure-treated

PALMAKO CONNECT
196-255



PALMAKO CONNECT
BIANCA SET 101 8,3 m²



PALMAKO CONNECT
BIANCA SET 107 16,6 m²



PALMAKO CONNECT
BIANCA SET 108 16,6 m²



PALMAKO CONNECT
BIANCA SET 102 8,3 m²



PALMAKO CONNECT
BIANCA SET 109 16,6 m²



PALMAKO CONNECT
BIANCA SET 103 8,3 m²



PALMAKO CONNECT
BIANCA SET 110 16,6 m²



PALMAKO CONNECT
BIANCA 8,3 m²
SET 201 SLIDE / SET 501 SLIDE PLUS



PALMAKO CONNECT
BIANCA 16,6 m²
SET 202 SLIDE / SET 502 SLIDE PLUS



PALMAKO CONNECT
BIANCA 16,6 m²
SET 203 SLIDE / SET 503 SLIDE PLUS



PALMAKO CONNECT
BIANCA 16,6 m²
SET 204 SLIDE / SET 504 SLIDE PLUS



PALMAKO CONNECT
BIANCA 16,6 m²
SET 205 SLIDE / SET 505 SLIDE PLUS



PALMAKO CONNECT
BIANCA 16,6 m²
SET 206 SLIDE / SET 506 SLIDE PLUS



PALMAKO CONNECT
BIANCA 16,6 m²
SET 207 SLIDE / SET 507 SLIDE PLUS



PALMAKO CONNECT
BIANCA 16,6 m²
SET 208 SLIDE / SET 508 SLIDE PLUS



PALMAKO CONNECT
BIANCA 24,9 m²
SET 211 SLIDE / SET 511 SLIDE PLUS



PALMAKO CONNECT
BIANCA 24,9 m²
SET 212 SLIDE / SET 512 SLIDE PLUS



PALMAKO CONNECT
BIANCA 24,9 m²
SET 209 SLIDE / SET 509 SLIDE PLUS



PALMAKO CONNECT
BIANCA 24,9 m²
SET 210 SLIDE / SET 510 SLIDE PLUS



PALMAKO CONNECT
BIANCA 24,9 m²
SET 222 SLIDE / SET 522 SLIDE PLUS



PALMAKO CONNECT
BIANCA 24,9 m²
SET 223 SLIDE / SET 523 SLIDE PLUS



PALMAKO CONNECT
BIANCA 24,9 m²
SET 213 SLIDE / SET 513 SLIDE PLUS



PALMAKO CONNECT
BIANCA 24,9 m²
SET 214 SLIDE / SET 514 SLIDE PLUS



PALMAKO CONNECT
BIANCA 24,9 m²
SET 215 SLIDE / SET 515 SLIDE PLUS



PALMAKO CONNECT
BIANCA 24,9 m²
SET 216 SLIDE / SET 516 SLIDE PLUS



PALMAKO CONNECT
BIANCA 24,9 m²
SET 219 SLIDE / SET 519 SLIDE PLUS



PALMAKO CONNECT
BIANCA 24,9 m²
SET 217 SLIDE / SET 517 SLIDE PLUS



PALMAKO CONNECT
BIANCA 24,9 m²
SET 218 SLIDE / SET 518 SLIDE PLUS



PALMAKO CONNECT
BIANCA 33,2 m²
SET 220 SLIDE / SET 520 SLIDE PLUS



PALMAKO CONNECT
BIANCA 33,2 m²
SET 221 SLIDE / SET 521 SLIDE PLUS



PALMAKO CONNECT
BIANCA KIOSK SET 104 8,3 m²



PALMAKO CONNECT
BIANCA KIOSK SET 105 8,3 m²



PALMAKO CONNECT
BIANCA KIOSK SET 106 8,3 m²



PALMAKO CONNECT
BIANCA KIOSK SET 111 16,6 m²



PALMAKO CONNECT
BIANCA KIOSK SET 112 16,6 m²

PALMAKO CONNECT
196-255

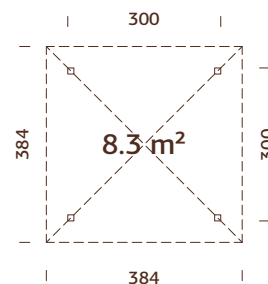
PALMAKO BIANCA 8,3 m²

Strong posts from laminated wood.

MODEL SPECIFICATIONS

Measurements: 300x300 cm

Volume: 22,5 m³

Gross ground area: 9,0 m²

Roof boards: 19 mm

Roof area: 18,4 m²

Roof gradient: 30,0°

TREATMENT

Available dipped

Available painted

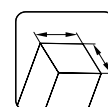

120x120 mm

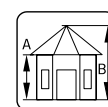

A: 210 cm
B: 319 cm

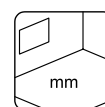

NB! Floor is an optional extra! 28 mm

OPTIONAL

Floor (outdoor/as terrace), Bianca extra roof with two posts, full wall, Louvre wall, wall with hatch, half wall corner, fence, apex, sliding door Slide, sliding door Slide Plus, roofing felt (underlayer): 6 rolls, shingles: 9 packs, roofing nails, rain gutters.

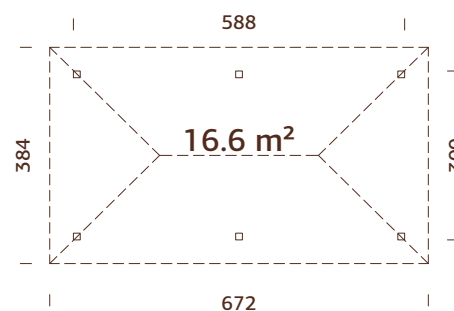
PALMAKO BIANCA 16,6 m²

Strong posts from laminated wood.

MODEL SPECIFICATIONS

Measurements: 588x300 cm

Volume: 43,9 m³

Gross ground area: 17,6 m²

Roof boards: 19 mm

Roof area: 31,5 m²

Roof gradient: 30,0°

TREATMENT

Available dipped

Available painted

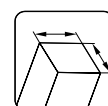

120x120 mm

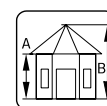

A: 210 cm
B: 319 cm

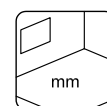

NB! Floor is an optional extra! 28 mm

OPTIONAL

Floor (outdoor/as terrace), Bianca extra roof with two posts, full wall, Louvre wall, wall with hatch, half wall corner, fence, apex, sliding door Slide, sliding door Slide Plus, roofing felt (underlayer): 9 rolls, shingles: 14 packs, roofing nails, rain gutters.

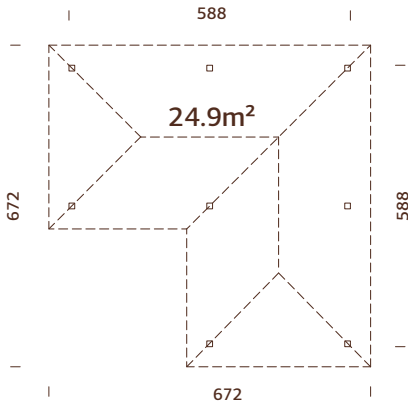
PALMAKO BIANCA 24,9 m²

Strong posts from laminated wood.

TREATMENT

Available dipped

Available painted

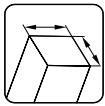

120x120 mm

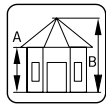

A: 210 cm
B: 319 cm

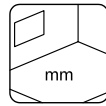

NB! Floor is an optional extra! 28 mm

MODEL SPECIFICATIONS

Measurements: 588x588 cm

Volume: 66,0 m³

Gross ground area: 26,3 m²

Roof boards: 19 mm

Roof area: 48,0 m²

Roof gradient: 30,0°

OPTIONAL

Floor (outdoor/as terrace), Bianca extra roof with two posts, full wall, Louvre wall, wall with hatch, half wall corner, fence, apex, sliding door Slide, sliding door Slide Plus, roofing felt (underlayer): 11 rolls, shingles: 18 packs, roofing nails, rain gutters.



Bianca 24,9 m²

PALMAKO CONNECT BIANCA SET 101 8,3 m²



Strong posts from laminated wood.

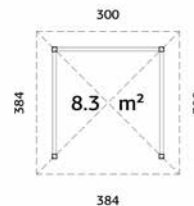

TREATMENT

- Available dipped
- Available painted

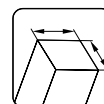

120x120 mm

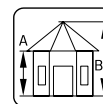

A: 210 cm
B: 319 cm

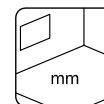

NB! Floor is an optional extra! 28 mm

MODEL SPECIFICATIONS

See page 206.

OPTIONAL

Floor (outdoor/as terrace), roofing felt (underlayer): 6 rolls, shingles: 9 packs, roofing nails, rain gutters.

PALMAKO CONNECT BIANCA SET 107 16,6 m²



Strong posts from laminated wood.

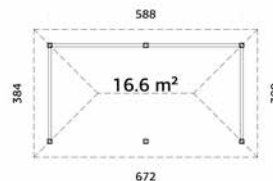

TREATMENT

- Available dipped
- Available painted

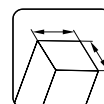

120x120 mm

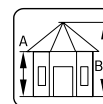

A: 210 cm
B: 319 cm

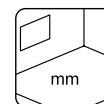

NB! Floor is an optional extra! 28 mm

MODEL SPECIFICATIONS

See page 206.

OPTIONAL

Floor (outdoor/as terrace), roofing felt (underlayer): 9 rolls, shingles: 14 packs, roofing nails, rain gutters.

PALMAKO CONNECT BIANCA SET 108 16,6 m²



Strong posts from laminated wood.
Wall components are interchangeable.

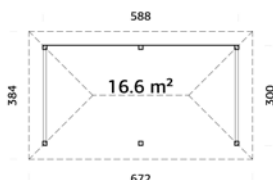

TREATMENT

- Available dipped
- Available painted

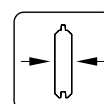

28 mm

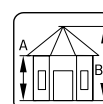

A: 210 cm
B: 319 cm

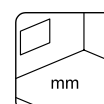

NB! Floor is an optional extra! 28 mm

MODEL SPECIFICATIONS

See page 206.

OPTIONAL

Floor (outdoor/as terrace), roofing felt (underlayer): 9 rolls, shingles: 14 packs, roofing nails, rain gutters.

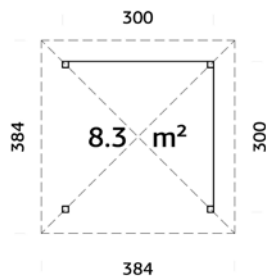
PALMAKO CONNECT BIANCA SET 102 8,3 m²

Strong posts from laminated wood.

TREATMENT

Available dipped

Available painted

MODEL SPECIFICATIONS

See page 206.

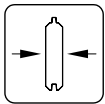

28 mm

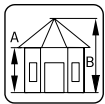

A: 210 cm
B: 319 cm

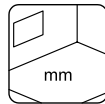

NB! Floor is an optional extra! 28 mm

OPTIONAL

Floor (outdoor/as terrace), roofing felt (underlayer): 6 rolls, shingles: 9 packs, roofing nails, rain gutters.

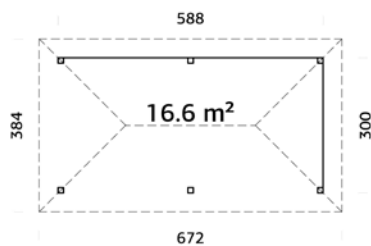
PALMAKO CONNECT BIANCA SET 109 16,6 m²

Strong posts from laminated wood.

TREATMENT

Available dipped

Available painted

MODEL SPECIFICATIONS

See page 206.



Can be built in reverse!

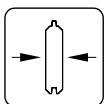

28 mm

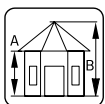

A: 210 cm
B: 319 cm

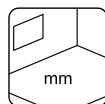

NB! Floor is an optional extra! 28 mm

OPTIONAL

Floor (outdoor/as terrace), roofing felt (underlayer): 9 rolls, shingles: 14 packs, roofing nails, rain gutters.

PALMAKO CONNECT BIANCA SET 103 8,3 m²

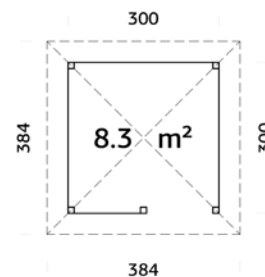

Strong posts from laminated wood.
Wall components are interchangeable.
Open wall solution.

MODEL SPECIFICATIONS

See page 206.

Can be built in reverse!

TREATMENT

- Available dipped
- Available painted

OPTIONAL

Floor (outdoor/as terrace), roofing felt (underlayer): 6 rolls, shingles: 9 packs, roofing nails, rain gutters.

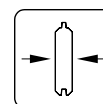

28 mm

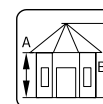

A: 210 cm
B: 319 cm

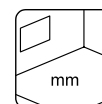

NB! Floor is an optional extra! 28 mm

PALMAKO CONNECT BIANCA SET 110 16,6 m²

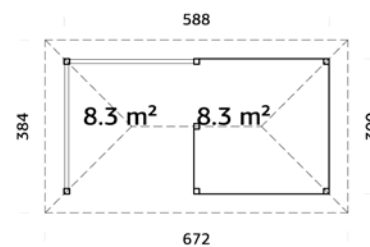

Strong posts from laminated wood.
Wall components are interchangeable.
Open wall solution.

MODEL SPECIFICATIONS

See page 206.

Can be built in reverse!

TREATMENT

- Available dipped
- Available painted

OPTIONAL

Floor (outdoor/as terrace), roofing felt (underlayer): 9 rolls, shingles: 14 packs, roofing nails, rain gutters.

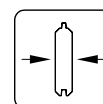

28 mm

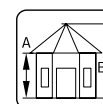

A: 210 cm
B: 319 cm

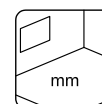

NB! Floor is an optional extra! 28 mm



Bianca 8,3 m² Set 102



Bianca 16,6 m² Set 110



Bianca 16,6 m² Set 203 Slide



Bianca 16,6 m² Set 203 Slide interior view



PALMAKO CONNECT BIANCA 8,3 m²

SET 201 SLIDE / SET 501 SLIDE PLUS

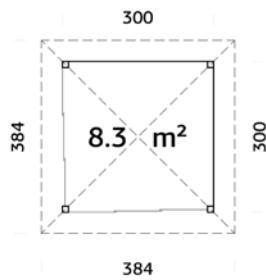

PALMAKO CONNECT
196-255

Sliding doors included.
Strong posts from laminated wood.
Wall components are interchangeable.

TREATMENT

Available dipped
Available painted

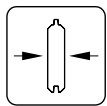

28 mm

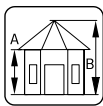

A: 210 cm
B: 319 cm

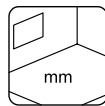

NB! Floor is an optional extra! 28 mm

MODEL SPECIFICATIONS

See page 206.



Slide

Single glass, toughened, 4 mm



Slide Plus

Double glass, toughened, 4-16-4 mm

OPTIONAL

Floor (indoor), roofing felt (underlayer): 6 rolls, shingles: 9 packs, roofing nails, rain gutters.

PALMAKO CONNECT BIANCA 16,6 m²

SET 202 SLIDE / SET 502 SLIDE PLUS

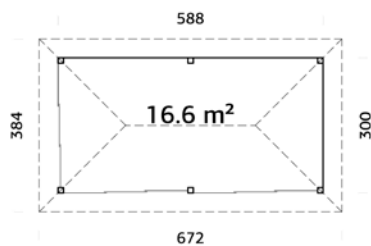

Can be built in reverse!

Sliding doors included.
Strong posts from laminated wood.
Wall components are interchangeable.

TREATMENT

Available dipped
Available painted

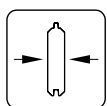

28 mm

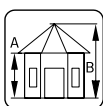

A: 210 cm
B: 319 cm

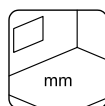

NB! Floor is an optional extra! 28 mm

MODEL SPECIFICATIONS

See page 206.



Slide

Single glass, toughened, 4 mm



Slide Plus

Double glass, toughened, 4-16-4 mm

OPTIONAL

Floor (indoor), roofing felt (underlayer): 9 rolls, shingles: 14 packs, roofing nails, rain gutters.

PALMAKO CONNECT BIANCA 16,6 m²

SET 203 SLIDE / SET 503 SLIDE PLUS

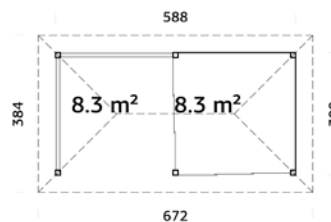

Sliding doors included.
Strong posts from laminated wood.
Wall components are interchangeable.

MODEL SPECIFICATIONS

See page 206.



Can be built in reverse!



Slide

Single glass, toughened, 4 mm



Slide Plus

Double glass, toughened, 4-16-4 mm

OPTIONAL

Floor (outdoor/as terrace), floor (indoor), roofing felt (underlayer): 9 rolls, shingles: 14 packs, roofing nails, rain gutters.

TREATMENT

- Available dipped
- Available painted

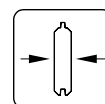

28 mm

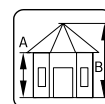

A: 210 cm
B: 319 cm

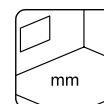

NB! Floor is an optional extra! 28 mm

PALMAKO CONNECT BIANCA 16,6 m²

SET 204 SLIDE / SET 504 SLIDE PLUS

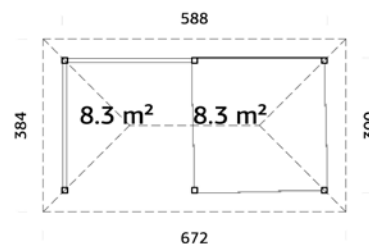

Sliding doors included.
Strong posts from laminated wood.
Wall components are interchangeable.

MODEL SPECIFICATIONS

See page 206.



Can be built in reverse!



Slide

Single glass, toughened, 4 mm



Slide Plus

Double glass, toughened, 4-16-4 mm

OPTIONAL

Floor (outdoor/as terrace), floor (indoor), roofing felt (underlayer): 9 rolls, shingles: 14 packs, roofing nails, rain gutters.

TREATMENT

- Available dipped
- Available painted

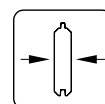

28 mm

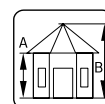

A: 210 cm
B: 319 cm

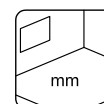

NB! Floor is an optional extra! 28 mm



PALMAKO CONNECT BIANCA 16,6 m²

SET 205 SLIDE / SET 505 SLIDE PLUS

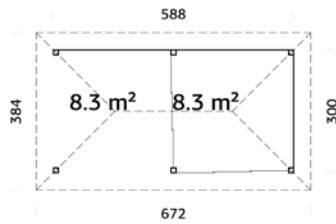

Sliding doors included.
Strong posts from laminated wood.
Wall components are interchangeable.

MODEL SPECIFICATIONS

See page 206.



Can be built in reverse!

TREATMENT

Available dipped
Available painted

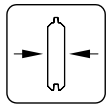

28 mm

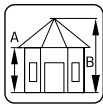

A: 210 cm
B: 319 cm

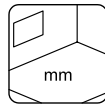

NB! Floor is an optional extra! 28 mm



Slide

Single glass, toughened, 4 mm



Slide Plus

Double glass, toughened, 4-16-4 mm

OPTIONAL

Floor (outdoor/as terrace), floor (indoor), roofing felt (underlayer): 9 rolls, shingles: 14 packs, roofing nails, rain gutters.

PALMAKO CONNECT BIANCA 16,6 m²

SET 206 SLIDE / SET 506 SLIDE PLUS

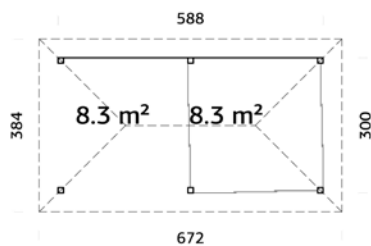

Sliding doors included.
Strong posts from laminated wood.
Wall components are interchangeable.

MODEL SPECIFICATIONS

See page 206.



Can be built in reverse!

TREATMENT

Available dipped
Available painted

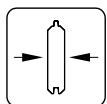

28 mm

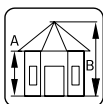

A: 210 cm
B: 319 cm

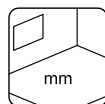

NB! Floor is an optional extra! 28 mm



Slide

Single glass, toughened, 4 mm



Slide Plus

Double glass, toughened, 4-16-4 mm

OPTIONAL

Floor (outdoor/as terrace), floor (indoor), roofing felt (underlayer): 9 rolls, shingles: 14 packs, roofing nails, rain gutters.

PALMAKO CONNECT BIANCA 16,6 m²

SET 207 SLIDE / SET 507 SLIDE PLUS

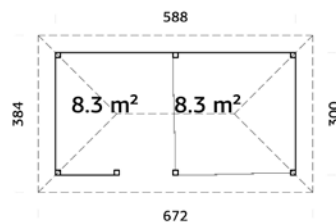

Sliding doors included.
Strong posts from laminated wood.
Wall components are interchangeable.
Open wall solution.

MODEL SPECIFICATIONS

See page 206.



Slide

Single glass, toughened, 4 mm



Slide Plus

Double glass, toughened, 4-16-4 mm



Can be built in reverse!

TREATMENT

- Available dipped
- Available painted

OPTIONAL

Floor (outdoor/as terrace), floor (indoor), roofing felt (underlayer): 9 rolls, shingles: 14 packs, roofing nails, rain gutters.

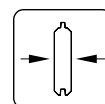

28 mm

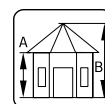

A: 210 cm
B: 319 cm

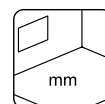

NB! Floor is an optional extra! 28 mm

PALMAKO CONNECT BIANCA 16,6 m²

SET 208 SLIDE / SET 508 SLIDE PLUS

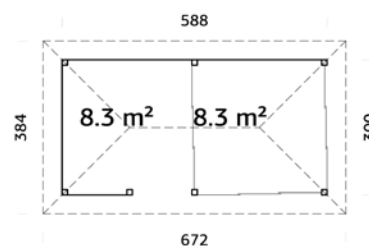

Sliding doors included.
Strong posts from laminated wood.
Wall components are interchangeable.
Open wall solution.

MODEL SPECIFICATIONS

See page 206.



Slide

Single glass, toughened, 4 mm



Slide Plus

Double glass, toughened, 4-16-4 mm



Can be built in reverse!

TREATMENT

- Available dipped
- Available painted

OPTIONAL

Floor (outdoor/as terrace), floor (indoor), roofing felt (underlayer): 9 rolls, shingles: 14 packs, roofing nails, rain gutters.

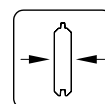

28 mm

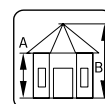

A: 210 cm
B: 319 cm

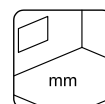

NB! Floor is an optional extra! 28 mm



PALMAKO CONNECT BIANCA 24,9 m²

SET 211 SLIDE / SET 511 SLIDE PLUS

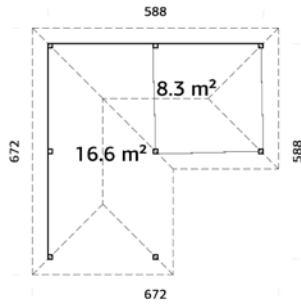

Sliding doors included.
Strong posts from laminated wood.
Wall components are interchangeable.

MODEL SPECIFICATIONS

See page 207.



Can be built in reverse!

TREATMENT

Available dipped

Available painted



Slide

Single glass, toughened, 4 mm



Slide Plus

Double glass, toughened, 4-16-4 mm

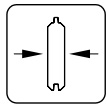

28 mm

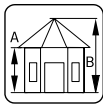

A: 210 cm
B: 319 cm

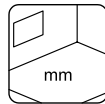

NB! Floor is an optional extra! 28 mm

OPTIONAL

Floor (outdoor/as terrace), floor (indoor), roofing felt (underlayer): 11 rolls, shingles: 18 packs, roofing nails, rain gutters.

PALMAKO CONNECT BIANCA 24,9 m²

SET 212 SLIDE / SET 512 SLIDE PLUS

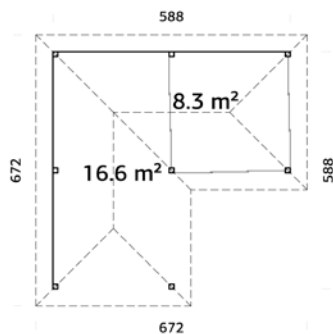

Sliding doors included.
Strong posts from laminated wood.
Wall components are interchangeable.

MODEL SPECIFICATIONS

See page 207.



Can be built in reverse!

TREATMENT

Available dipped

Available painted



Slide

Single glass, toughened, 4 mm



Slide Plus

Double glass, toughened, 4-16-4 mm

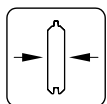

28 mm

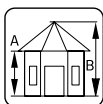

A: 210 cm
B: 319 cm

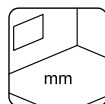

NB! Floor is an optional extra! 28 mm

OPTIONAL

Floor (outdoor/as terrace), floor (indoor), roofing felt (underlayer): 11 rolls, shingles: 18 packs, roofing nails, rain gutters.

PALMAKO CONNECT BIANCA 24,9 m²

SET 209 SLIDE / SET 509 SLIDE PLUS



PALMAKO CONNECT

196-255

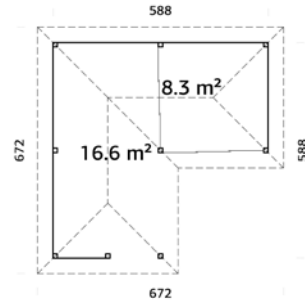

MODEL SPECIFICATIONS

See page 207.



Can be built in reverse!



Slide

Single glass, toughened, 4 mm



Slide Plus

Double glass, toughened, 4-16-4 mm

OPTIONAL

Floor (outdoor/as terrace), floor (indoor), roofing felt (underlayer): 11 rolls, shingles: 18 packs, roofing nails, rain gutters.

Sliding doors included.
Strong posts from laminated wood.
Wall components are interchangeable.
Open wall solution.

TREATMENT

Available dipped

Available painted

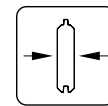

28 mm

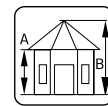

A: 210 cm
B: 319 cm

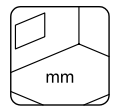

NB! Floor is an optional extra! 28 mm

PALMAKO CONNECT BIANCA 24,9 m²

SET 210 SLIDE / SET 510 SLIDE PLUS

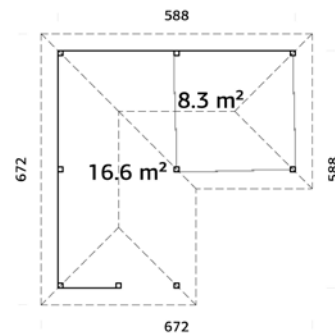

MODEL SPECIFICATIONS

See page 207.



Can be built in reverse!



Slide

Single glass, toughened, 4 mm



Slide Plus

Double glass, toughened, 4-16-4 mm

OPTIONAL

Floor (outdoor/as terrace), floor (indoor), roofing felt (underlayer): 11 rolls, shingles: 18 packs, roofing nails, rain gutters.

Sliding doors included.
Strong posts from laminated wood.
Wall components are interchangeable.
Open wall solution.

TREATMENT

Available dipped

Available painted

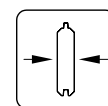

28 mm

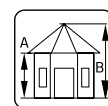

A: 210 cm
B: 319 cm

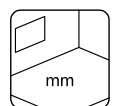

NB! Floor is an optional extra! 28 mm



PALMAKO CONNECT BIANCA 24,9 m²

SET 222 SLIDE / SET 522 SLIDE PLUS

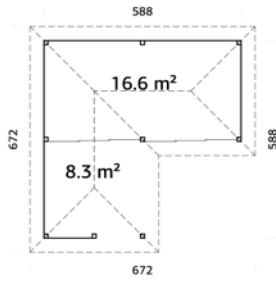

PALMAKO CONNECT
196-255

Sliding doors included.
Strong posts from laminated wood.
Wall components are interchangeable.
Open wall solution.

MODEL SPECIFICATIONS

See page 207.



Can be built in reverse!

TREATMENT

- Available dipped
- Available painted

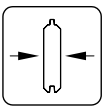

28 mm

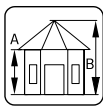

A: 210 cm
B: 319 cm

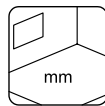

NB! Floor is an optional extra! 28 mm



Slide

Single glass, toughened, 4 mm



Slide Plus

Double glass, toughened, 4-16-4 mm

OPTIONAL

Floor (outdoor/as terrace), floor (indoor), roofing felt (underlayer): 11 rolls, shingles: 18 packs, roofing nails, rain gutters.

PALMAKO CONNECT BIANCA SET 24,9 m²

SET 223 SLIDE / SET 523 SLIDE PLUS

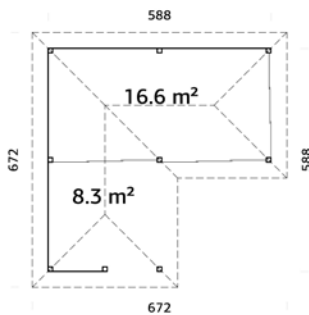

Sliding doors included.
Strong posts from laminated wood.
Wall components are interchangeable.
Open wall solution.

MODEL SPECIFICATIONS

See page 207.



Can be built in reverse!

TREATMENT

- Available dipped
- Available painted

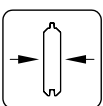

28 mm

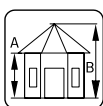

A: 210 cm
B: 319 cm

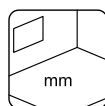

NB! Floor is an optional extra! 28 mm



Slide

Single glass, toughened, 4 mm



Slide Plus

Double glass, toughened, 4-16-4 mm

OPTIONAL

Floor (outdoor/as terrace), floor (indoor), roofing felt (underlayer): 11 rolls, shingles: 18 packs, roofing nails, rain gutters.

PALMAKO CONNECT BIANCA 24,9 m²

SET 213 SLIDE / SET 513 SLIDE PLUS

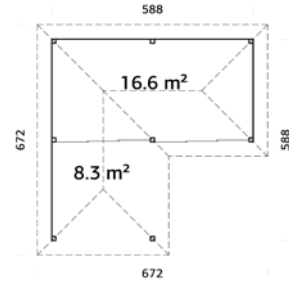

Sliding doors included.
Strong posts from laminated wood.
Wall components are interchangeable.

MODEL SPECIFICATIONS

See page 207.



Can be built in reverse!



Slide



Slide Plus

Single glass, toughened, 4 mm

Double glass, toughened, 4-16-4 mm

OPTIONAL

Floor (outdoor/as terrace), floor (indoor), roofing felt (underlayer): 11 rolls, shingles: 18 packs, roofing nails, rain gutters.

TREATMENT

Available dipped

Available painted

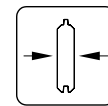

28 mm

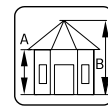

A: 210 cm
B: 319 cm

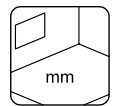

NB! Floor is an optional extra! 28 mm

PALMAKO CONNECT BIANCA 24,9 m²

SET 214 SLIDE / SET 514 SLIDE PLUS

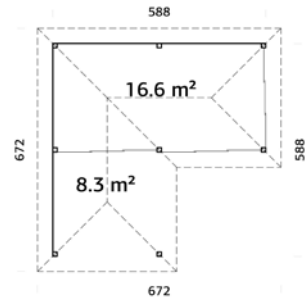

Sliding doors included.
Strong posts from laminated wood.
Wall components are interchangeable.

MODEL SPECIFICATIONS

See page 207.



Can be built in reverse!



Slide



Slide Plus

Single glass, toughened, 4 mm

Double glass, toughened, 4-16-4 mm

OPTIONAL

Floor (outdoor/as terrace), floor (indoor), roofing felt (underlayer): 11 rolls, shingles: 18 packs, roofing nails, rain gutters.

TREATMENT

Available dipped

Available painted

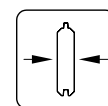

28 mm

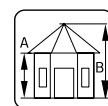

A: 210 cm
B: 319 cm

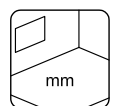

NB! Floor is an optional extra! 28 mm



Bianca 24,9 m² Set 214 Slide



Bianca 24,9 m² Set 214 Slide interior view



Bianca 24,9 m² Set 519 Slide Plus

PALMAKO CONNECT BIANCA 24,9 m²

SET 215 SLIDE / SET 515 SLIDE PLUS



MODEL SPECIFICATIONS

See page 207.



Can be built in reverse!



Slide

Single glass, toughened, 4 mm



Slide Plus

Double glass, toughened,
4-16-4 mm

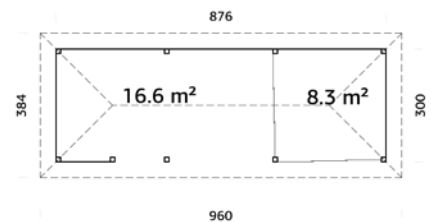

Sliding doors included.

Strong posts from laminated wood.

Wall components are interchangeable.

Open wall solution.

TREATMENT

Available dipped

Available painted

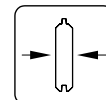

28 mm

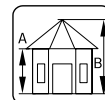

A: 210 cm

B: 319 cm

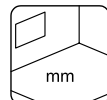

NB! Floor is an optional extra! 28 mm

OPTIONAL

Floor (outdoor/as terrace), floor (indoor), roofing felt (underlayer): 9 rolls, shingles: 18 packs, roofing nails, rain gutters.



PALMAKO CONNECT BIANCA 24,9 m²

SET 216 SLIDE / SET 516 SLIDE PLUS

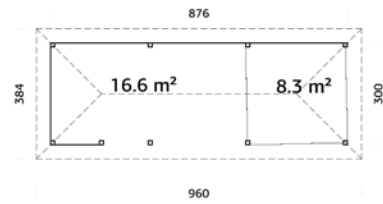

Sliding doors included.
Strong posts from laminated wood.
Wall components are interchangeable.
Open wall solution.

MODEL SPECIFICATIONS

See page 207.

TREATMENT

- Available dipped
Available painted



Slide

Single glass, toughened, 4 mm



Slide Plus

Double glass, toughened, 4-16-4 mm



Can be built in reverse!

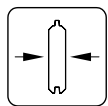

28 mm

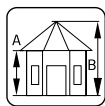

A: 210 cm
B: 319 cm

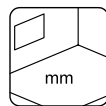

NB! Floor is an optional extra! 28 mm

OPTIONAL

Floor (outdoor/as terrace), floor (indoor), roofing felt (underlayer): 9 rolls, shingles: 18 packs, roofing nails, rain gutters.

PALMAKO CONNECT BIANCA 24,9 m²

SET 219 SLIDE / SET 519 SLIDE PLUS

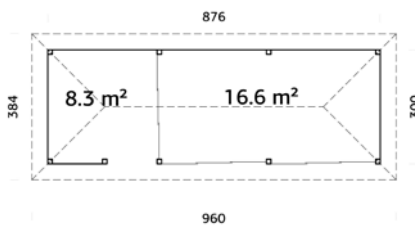

Sliding doors included.
Strong posts from laminated wood.
Wall components are interchangeable.
Open wall solution.

MODEL SPECIFICATIONS

See page 207.

TREATMENT

- Available dipped
Available painted



Slide

Single glass, toughened, 4 mm



Slide Plus

Double glass, toughened, 4-16-4 mm



Can be built in reverse!

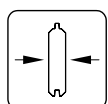

28 mm

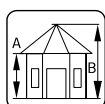

A: 210 cm
B: 319 cm

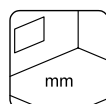

NB! Floor is an optional extra! 28 mm

OPTIONAL

Floor (outdoor/as terrace), floor (indoor), roofing felt (underlayer): 9 rolls, shingles: 18 packs, roofing nails, rain gutters.

PALMAKO CONNECT BIANCA 24,9 m²

SET 217 SLIDE / SET 517 SLIDE PLUS

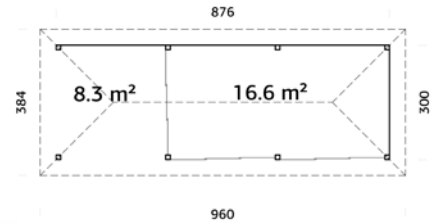

Sliding doors included.
Strong posts from laminated wood.
Wall components are interchangeable.



Can be built in reverse!

MODEL SPECIFICATIONS

See page 207.



Slide

Single glass, toughened, 4 mm



Slide Plus

Double glass, toughened, 4-16-4 mm

OPTIONAL

Floor (outdoor/as terrace), floor (indoor), roofing felt (underlayer): 9 rolls, shingles: 18 packs, roofing nails, rain gutters.

TREATMENT

Available dipped

Available painted

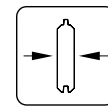

28 mm

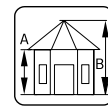

A: 210 cm
B: 319 cm

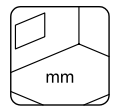

NB! Floor is an optional extra! 28 mm

PALMAKO CONNECT BIANCA 24,9 m²

SET 218 SLIDE / SET 518 SLIDE PLUS

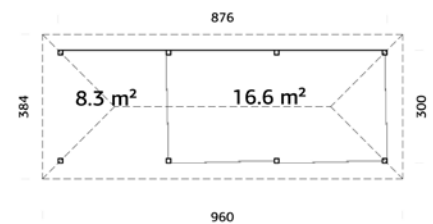

Sliding doors included.
Strong posts from laminated wood.
Wall components are interchangeable.



Can be built in reverse!

MODEL SPECIFICATIONS

See page 207.



Slide

Single glass, toughened, 4 mm



Slide Plus

Double glass, toughened, 4-16-4 mm

OPTIONAL

Floor (outdoor/as terrace), floor (indoor), roofing felt (underlayer): 9 rolls, shingles: 18 packs, roofing nails, rain gutters.

TREATMENT

Available dipped

Available painted

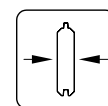

28 mm

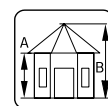

A: 210 cm
B: 319 cm

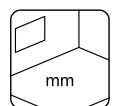

NB! Floor is an optional extra! 28 mm



PALMAKO CONNECT BIANCA 33,2 m²

SET 220 SLIDE / SET 520 SLIDE PLUS

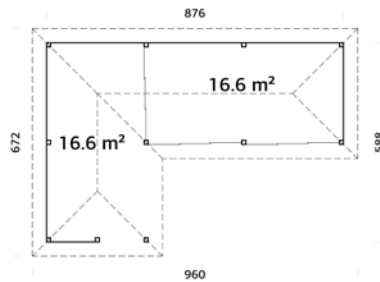

Sliding doors included.
Strong posts from laminated wood.
Wall components are interchangeable.
Open wall solution.

MODEL SPECIFICATIONS

See page 207.



Can be built in reverse!

TREATMENT

Available dipped
Available painted

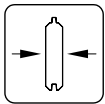

28 mm

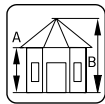

A: 210 cm
B: 319 cm

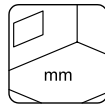

NB! Floor is an optional extra! 28 mm



Slide

Single glass, toughened, 4 mm



Slide Plus

Double glass, toughened, 4-16-4 mm

OPTIONAL

Floor (outdoor/as terrace), floor (indoor), roofing felt (underlayer): 14 rolls, shingles: 25 packs, roofing nails.

PALMAKO CONNECT BIANCA 33,2 m²

SET 221 SLIDE / SET 521 SLIDE PLUS

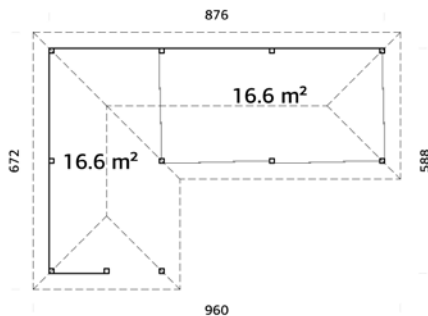

Sliding doors included.
Strong posts from laminated wood.
Wall components are interchangeable.
Open wall solution.

MODEL SPECIFICATIONS

See page 207.



Can be built in reverse!

TREATMENT

Available dipped
Available painted

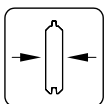

28 mm

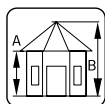

A: 210 cm
B: 319 cm

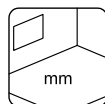

NB! Floor is an optional extra! 28 mm



Slide

Single glass, toughened, 4 mm



Slide Plus

Double glass, toughened, 4-16-4 mm

OPTIONAL

Floor (outdoor/as terrace), floor (indoor), roofing felt (underlayer): 14 rolls, shingles: 25 packs, roofing nails.

PALMAKO CONNECT BIANCA KIOSK SET 104 8,3 m²



Strong posts from laminated wood.
Wall components are interchangeable.

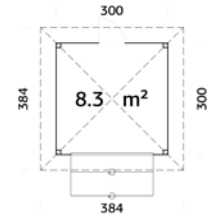

TREATMENT

- Available dipped
- Available painted

MODEL SPECIFICATIONS

See page 206.

OPTIONAL

Floor (indoor), roofing felt (underlayer): 6 rolls, shingles: 9 packs, roofing nails, rain gutters.

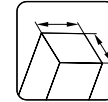

120x120 mm

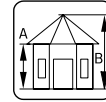

A: 210 cm
B: 319 cm

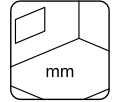

NB! Floor is an optional extra! 28 mm

PALMAKO CONNECT BIANCA KIOSK SET 105 8,3 m²



Strong posts from laminated wood.
Wall components are interchangeable.

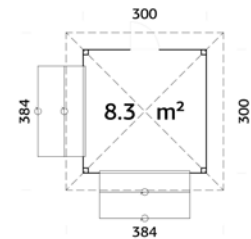

TREATMENT

- Available dipped
- Available painted

MODEL SPECIFICATIONS

See page 206.

OPTIONAL

Floor (indoor), roofing felt (underlayer): 6 rolls, shingles: 9 packs, roofing nails, rain gutters.

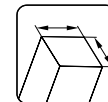

120x120 mm

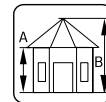

A: 210 cm
B: 319 cm

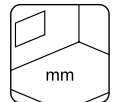

NB! Floor is an optional extra! 28 mm

PALMAKO CONNECT BIANCA KIOSK SET 106 8,3 m²



Strong posts from laminated wood.
Wall components are interchangeable.

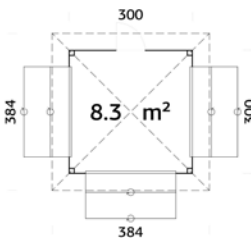

TREATMENT

- Available dipped
- Available painted

MODEL SPECIFICATIONS

See page 206.

OPTIONAL

Floor (indoor), roofing felt (underlayer): 6 rolls, shingles: 9 packs, roofing nails, rain gutters.

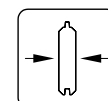

28 mm

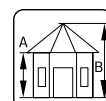

A: 210 cm
B: 319 cm

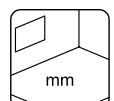

NB! Floor is an optional extra! 28 mm

PALMAKO CONNECT BIANCA KIOSK SET 111 16,6 m²

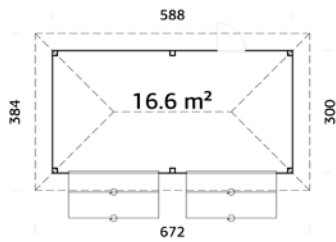

Strong posts from laminated wood.
Wall components are interchangeable.

TREATMENT

- Available dipped
- Available painted

MODEL SPECIFICATIONS

See page 206.

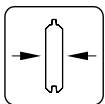

28 mm

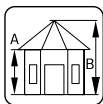

A: 210 cm
B: 319 cm

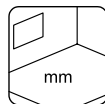

NB! Floor is an optional extra! 28 mm

OPTIONAL

Floor (indoor), roofing felt (underlayer): 9 rolls, shingles: 14 packs, roofing nails, rain gutters.

PALMAKO CONNECT BIANCA KIOSK SET 112 16,6 m²

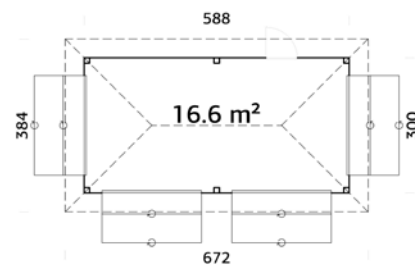

Strong posts from laminated wood.
Wall components are interchangeable.

TREATMENT

- Available dipped
- Available painted

MODEL SPECIFICATIONS

See page 206.

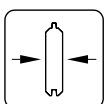

28 mm

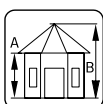

A: 210 cm
B: 319 cm

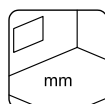

NB! Floor is an optional extra! 28 mm

OPTIONAL

Floor (indoor), roofing felt (underlayer): 9 rolls, shingles: 14 packs, roofing nails, rain gutters.

OPTIONAL PRODUCTS

SEE OPTIONAL PRODUCTS, PAGES 344-368

House	Art. No.	Bianca extra roof	Full wall	Wall with hatch	Wall with hatch	Half-wall corner	Apex	Fence	Floor ¹ (indoor)	Floor ² (outdoor/ as terrace)	Roofing felt (underlayer), rolls	Shingles ³ , packs	Roofing nails, 1 kg	Rain gutters
Bianca extra roof 8.3 m ²	109574								109811	105090	3 rolls	6 packs	107930	2 x 106630
Bianca 8.3 m ²	109592	109574	109575	110536	110786	109805	109410	109378	109811	105090	6 rolls	9 packs	107930	2x 106630
Bianca 16.6 m ²	110184	109574	109575	110536	110786	109805	109410	109378	109811	105090	9 rolls	14 packs	2x 107930	106629+2x 106630
Bianca 24.9 m ²	109581	109574	109575	110536	110786	109805	109410	109378	109811	105090	11 rolls	18 packs	3x 107930	2x 106629, 2x 106630
Bianca Set 101 8.3 m ²	110144								103090	103090	6 rolls	9 packs	107930	2x 106630
Bianca Set 107 16.6 m ²	111449								103090	103090	9 rolls	14 packs	2x 107930	106629+2x 106630
Bianca Set 108 16.6 m ²	110200								103090	103090	9 rolls	14 packs	2x 107930	106629+2x 106630
Bianca Set 102 8.3 m ²	111433								103090	103090	6 rolls	9 packs	107930	2x 106630
Bianca Set 109 16.6 m ²	111453								103090	103090	9 rolls	14 packs	2x 107930	106629+2x 106630
Bianca Set 103 8.3 m ²	110132								103090	103090	6 rolls	9 packs	107930	2x 106630
Bianca Set 110 16.6 m ²	110196								103090	103090	9 rolls	14 packs	2x 107930	106629+2x 106630
Bianca 8.3 m ² Set 201 Slide / Set 501 Slide Plus	111437 / 111907								109811		6 rolls	9 packs	107930	2x 106630
Bianca 16.6 m ² Set 202 Slide / Set 502 Slide Plus	111457 / 111911								109811		9 rolls	14 packs	2x 107930	106629+2 x 106630
Bianca 16.6 m ² Set 203 Slide / Set 503 Slide Plus	111461 / 111915								109811	103090	9 rolls	14 packs	2x 107930	106629+2x 106630
Bianca 16.6 m ² Set 204 Slide / Set 504 Slide Plus	111465 / 111919								109811	103090	9 rolls	14 packs	2x 107930	106629+2x 106630
Bianca 16.6 m ² Set 205 Slide / Set 505 Slide Plus	111469 / 111923								109811	103090	9 rolls	14 packs	2x 107930	106629+2x 106630
Bianca 16.6 m ² Set 206 Slide / Set 506 Slide Plus	111473 / 111927								109811	103090	9 rolls	14 packs	2x 107930	106629+2x 106630
Bianca 16.6 m ² Set 207 Slide / Set 507 Slide Plus	111477 / 111931								109811	103090	9 rolls	14 packs	2x 107930	106629+2x 106630
Bianca 16.6 m ² Set 208 Slide / Set 508 Slide Plus	111481 / 111935								109811	103090	9 rolls	14 packs	2x 107930	106629+2x 106630
Bianca Set 211 Slide 24.9 m ² / Set 511 Slide Plus	111493 / 111949								109811	103090	11 rolls	18 packs	2x 107930	2x 106629, 2x 106630

¹ Includes treated joists. ² Floor boards are pressure-treated and floor joists are treated. One floor set is suitable for 8.3 m².

³ Shingles are available in different colours - 107180 = Black, 107182 = Red, 107183 = Green, 107181 = Brown. The article number is indicated to untreated items, for treated items ask our sales team.

OPTIONAL PRODUCTS

SEE OPTIONAL PRODUCTS, PAGES 344-368

House	Art. No.	Bianca extra roof	Full wall	Wall with hatch	Wall with hatch	Half-wall corner	Apex	Fence	Floor ¹ (indoor)	Floor ² (outdoor/ as terrace)	Roofing felt (underlayer), rolls	Shingles ³ , packs	Roofing nails, 1 kg	Rain gutters
Bianca 24,9 m ² Set 212 Slide / Set 512 Slide Plus	111497 / 111953													
Bianca 24,9 m ² Set 209 Slide / Set 509 Slide Plus	111485 / 111941								109811	105090	11 rolls	18 packs	3x 107930	2x 106629, 2x 106630
Bianca 24,9 m ² Set 210 Slide / Set 510 Slide Plus	111489 / 111945								109811	105090	11 rolls	18 packs	3x 107930	2x 106629, 2x 106630
Bianca 24,9 m ² Set 222 Slide / Set 522 Slide Plus	111530 / 111993								109811	105090	11 rolls	18 packs	3x 107930	2x 106629, 2x 106630
Bianca 24,9 m ² Set 223 Slide / Set 523 Slide Plus	111534 / 111997								109811	105090	11 rolls	18 packs	3x 107930	2x 106629, 2x 106630
Bianca 24,9 m ² Set 213 Slide / Set 513 Slide Plus	111501 / 111957								109811	105090	11 rolls	18 packs	3x 107930	2x 106629, 2x 106630
Bianca 24,9 m ² Set 214 Slide / Set 514 Slide Plus	111505 / 111961								109811	105090	11 rolls	18 packs	3x 107930	2x 106629, 2x 106630
Bianca 24,9 m ² Set 215 Slide / Set 515 Slide Plus	111510 / 111965								109811	105090	9 rolls	18 packs	3x 107930	2x 106630+106632
Bianca 24,9 m ² Set 216 Slide / Set 516 Slide Plus	111514 / 111969								109811	105090	9 rolls	18 packs	3x 107930	2x 106630+106632
Bianca 24,9 m ² Set 219 Slide / Set 519 Slide Plus	111526 / 111981								109811	105090	9 rolls	18 packs	3x 107930	2x 106630+106632
Bianca 24,9 m ² Set 217 Slide / Set 517 Slide Plus	111518 / 111973								109811	105090	9 rolls	18 packs	3x 107930	2x 106630+106632
Bianca 24,9 m ² Set 218 Slide / Set 518 Slide Plus	111522 / 111977								109811	105090	9 rolls	18 packs	3x 107930	2x 106630+106632
Bianca 33,2 m ² Set 220 Slide / Set 520 Slide Plus	111538 / 111985								109811	105090	14 rolls	25 packs	3x 107930	106629+2x 106630+106632
Bianca 33,2 m ² Set 221 Slide / Set 521 Slide Plus	111542 / 111989								109811	105090	14 rolls	25 packs	3x 107930	106629+2x 106630+106632
Bianca Kiosk Set 104 8,3 m ²	111421								109811		6 rolls	9 packs	107930	2x 106630
Bianca Kiosk Set 105 8,3 m ²	111425								109811		6 rolls	9 packs	107930	2x 106630
Bianca Kiosk Set 106 8,3 m ²	111429								109811		6 rolls	9 packs	107930	2x 106630
Bianca Kiosk Set 111 16,6 m ²	111441								109811		9 rolls	14 packs	2x 107930	106629+ 2x 106630
Bianca Kiosk Set 112 16,6 m ²	111445								109811		9 rolls	14 packs	2x 107930	106629+ 2x 106630

¹ Includes treated joists. ² Floor boards are pressure-treated and floor joists are treated. One floor set is suitable for 8,3 m².

³ Shingles are available in different colours - 107180 = Black, 107182 = Red, 107183 = Green, 107181 = Brown. The article number is indicated to untreated items, for treated items ask our sales team.



PALMAKO CONNECT
LENNA SET 301 8,3 m²



PALMAKO CONNECT
LENNA SET 307 16,6 m²



PALMAKO CONNECT
LENNA SET 308 16,6 m²



PALMAKO CONNECT
LENNA SET 302 8,3 m²



PALMAKO CONNECT
LENNA SET 309 16,6 m²



PALMAKO CONNECT
LENNA SET 303 8,3 m²



PALMAKO CONNECT
LENNA SET 310 16,6 m²



PALMAKO CONNECT
LENNA 8,3 m²
SET 401 SLIDE / SET 701 SLIDE PLUS



PALMAKO CONNECT
LENNA 16,6 m²
SET 402 SLIDE / SET 702 SLIDE PLUS



PALMAKO CONNECT
LENNA 16,6 m²
SET 403 SLIDE / SET 703 SLIDE PLUS



PALMAKO CONNECT
LENNA 16,6 m²
SET 404 SLIDE / SET 704 SLIDE PLUS



PALMAKO CONNECT
LENNA 16,6 m²
SET 405 SLIDE / SET 705 SLIDE PLUS



PALMAKO CONNECT
LENNA 16,6 m²
SET 406 SLIDE / SET 706 SLIDE PLUS



PALMAKO CONNECT
LENNA 16,6 m²
SET 407 SLIDE / SET 707 SLIDE PLUS



PALMAKO CONNECT
LENNA 16,6 m²
SET 408 SLIDE / SET 708 SLIDE PLUS



PALMAKO CONNECT
LENNA 24,9 m²
SET 411 SLIDE / SET 711 SLIDE PLUS



PALMAKO CONNECT
LENNA 24,9 m²
SET 412 SLIDE / SET 712 SLIDE PLUS



PALMAKO CONNECT
LENNA 24,9 m²
SET 409 SLIDE / SET 709 SLIDE PLUS



PALMAKO CONNECT
LENNA 24,9 m²
SET 410 SLIDE / SET 710 SLIDE PLUS



PALMAKO CONNECT
LENNA 24,9 m²
SET 422 SLIDE / SET 722 SLIDE PLUS



PALMAKO CONNECT
LENNA 24,9 m²
SET 423 SLIDE / SET 723 SLIDE PLUS



PALMAKO CONNECT
LENNA 24,9 m²
SET 413 SLIDE / SET 713 SLIDE PLUS



PALMAKO CONNECT
LENNA 24,9 m²
SET 414 SLIDE / SET 714 SLIDE PLUS



PALMAKO CONNECT
LENNÄ 24,9 m²
SET 415 SLIDE / SET 715 SLIDE PLUS



PALMAKO CONNECT
LENNÄ 24,9 m²
SET 416 SLIDE / SET 716 SLIDE PLUS



PALMAKO CONNECT
LENNÄ 24,9 m²
SET 419 SLIDE / SET 719 SLIDE PLUS



PALMAKO CONNECT
LENNÄ 24,9 m²
SET 417 SLIDE / SET 717 SLIDE PLUS



PALMAKO CONNECT
LENNÄ 24,9 m²
SET 418 SLIDE / SET 718 SLIDE PLUS



PALMAKO CONNECT
LENNÄ 33,2 m²
SET 420 SLIDE / SET 720 SLIDE PLUS



PALMAKO CONNECT
LENNÄ 33,2 m²
SET 421 SLIDE / SET 721 SLIDE PLUS



PALMAKO CONNECT
LENNÄ KIOSK SET 304 8,3 m²



PALMAKO CONNECT
LENNÄ KIOSK SET 305 8,3 m²



PALMAKO CONNECT
LENNÄ KIOSK SET 306 8,3 m²



PALMAKO CONNECT
LENNÄ KIOSK SET 311 16,6 m²

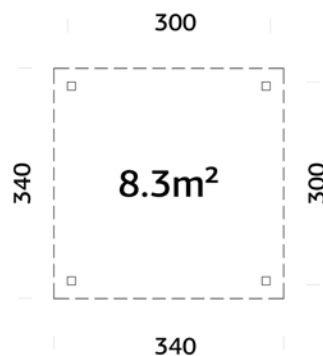

PALMAKO CONNECT
LENNÄ KIOSK SET 312 16,6 m²

PALMAKO LENNA 8,3 m²

Strong posts from laminated wood.

MODEL SPECIFICATIONS

Measurements: 300x300 cm

Volume: 22,5 m³

Gross ground area: 9,0 m²

Roof boards: 19 mm

Roof area: 11,6 m²

Roof gradient: 3,0°

TREATMENT

Available dipped

Available painted

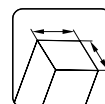

120x120 mm

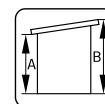

A: 210 cm
B: 245 cm

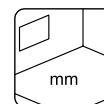

NB! Floor is an optional extra! 28 mm

OPTIONAL

Floor (outdoor/as terrace), Lenna extra roof with two posts, full wall, Louvre wall, wall with hatch, half wall corner, fence, sliding door Slide, sliding door Slide Plus, roofing felt (underlayer): 2 rolls, SBS roofing material: 2 rolls, roofing nails, EPDM, rain gutters.

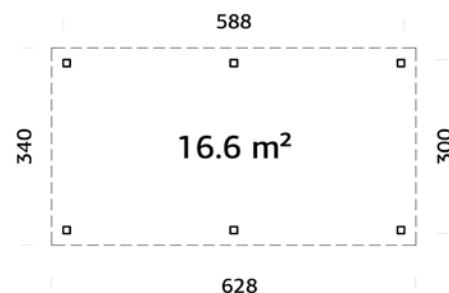
PALMAKO LENNA 16,6 m²

Strong posts from laminated wood.

MODEL SPECIFICATIONS

Measurements: 588x300 cm

Volume: 36,3 m³

Gross ground area: 17,6 m²

Roof boards: 19 mm

Roof area: 21,4 m²

Roof gradient: 3,0°

TREATMENT

Available dipped

Available painted

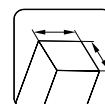

120x120 mm

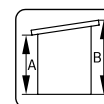

A: 210 cm
B: 245 cm

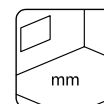

NB! Floor is an optional extra! 28 mm

OPTIONAL

Floor (outdoor/as terrace), Lenna extra roof with two posts, full wall, Louvre wall, wall with hatch, half wall corner, fence, sliding door Slide, sliding door Slide Plus, roofing felt (underlayer): 4 rolls, SBS roofing material: 4 rolls, roofing nails, EPDM, rain gutters.

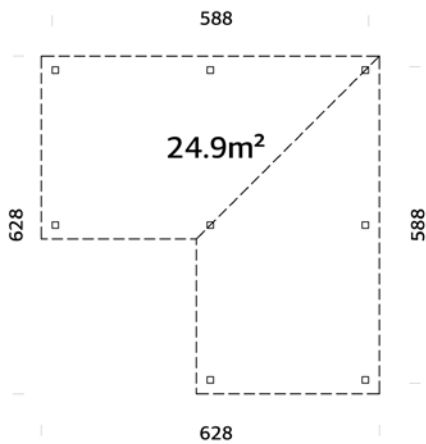
PALMAKO LENNA 24,9 m²

Strong posts from laminated wood.

TREATMENT

- Available dipped
 Available painted

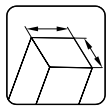

120x120 mm

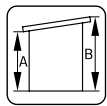

A: 210 cm
 B: 245 cm

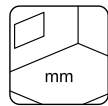

NB! Floor is an optional extra! 28 mm

MODEL SPECIFICATIONS

Measurements: 588x588 cm
 Volume: 57,9 m³
 Gross ground area: 26,3 m²

Roof boards: 19 mm
 Roof area: 31,5 m²
 Roof gradient: 3,0°

OPTIONAL

Floor (outdoor/as terrace), Lenna extra roof with two posts, full wall, Louvre wall, wall with hatch, half wall corner, fence, sliding door Slide, sliding door Slide Plus, roofing felt (underlayer): 9 rolls, SBS roofing material: 9 rolls, roofing nails, EPDM, rain gutters.



Lenna 33,2 m² Set 721 Slide Plus

PALMAKO CONNECT LENNA SET 301 8,3 m²

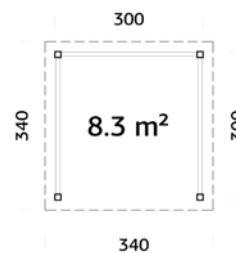

Strong posts from laminated wood.

MODEL SPECIFICATIONS

See page 232.

TREATMENT

- Available dipped
- Available painted

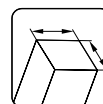

120x120 mm

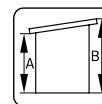

A: 210 cm
B: 245 cm

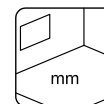

NB! Floor is an optional extra! 28 mm

OPTIONAL

Floor (outdoor/as terrace), floor (indoor), roofing felt (underlayer): 2 rolls, SBS roofing material: 2 rolls, roofing nails, EPDM, rain gutters.

PALMAKO CONNECT LENNA SET 307 16,6 m²

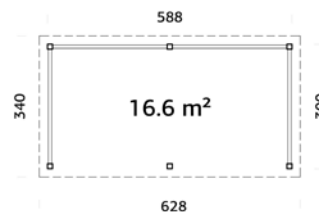

Strong posts from laminated wood.

MODEL SPECIFICATIONS

See page 232.

TREATMENT

- Available dipped
- Available painted

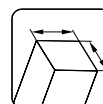

120x120 mm

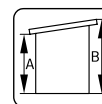

A: 210 cm
B: 245 cm

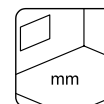

NB! Floor is an optional extra! 28 mm

OPTIONAL

Floor (outdoor/as terrace), floor (indoor), roofing felt (underlayer): 4 rolls, SBS roofing material: 4 rolls, roofing nails, EPDM, rain gutters.

PALMAKO CONNECT LENNA SET 308 16,6 m²

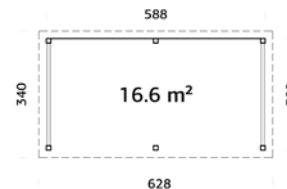

Strong posts from laminated wood.
Wall components are interchangeable.

MODEL SPECIFICATIONS

See page 232.

TREATMENT

- Available dipped
- Available painted

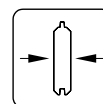

28 mm

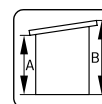

A: 210 cm
B: 245 cm

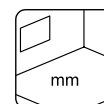

NB! Floor is an optional extra! 28 mm

OPTIONAL

Floor (outdoor/as terrace), floor (indoor), roofing felt (underlayer): 4 rolls, SBS roofing material: 4 rolls, roofing nails, EPDM, rain gutters.

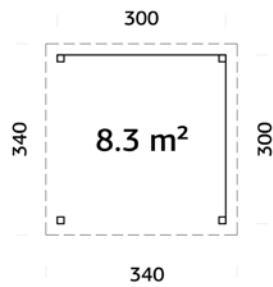
PALMAKO CONNECT LENNA SET 302 8,3 m²**MODEL SPECIFICATIONS**

See page 232.

Strong posts from laminated wood.

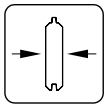
TREATMENTAvailable dipped Available painted 

28 mm

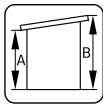
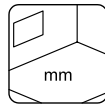
A: 210 cm
B: 245 cm

NB! Floor is an optional extra! 28 mm

OPTIONAL

Floor (outdoor/as terrace), floor (indoor), roofing felt (underlayer): 2 rolls, SBS roofing material: 2 rolls, roofing nails, EPDM, rain gutters.

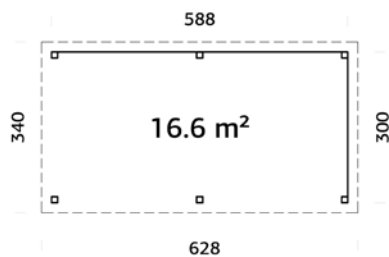
PALMAKO CONNECT LENNA SET 309 16,6 m²**MODEL SPECIFICATIONS**

See page 232.

Strong posts from laminated wood.

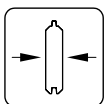
TREATMENTAvailable dipped Available painted 

28 mm

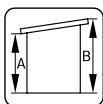
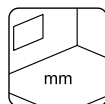
A: 210 cm
B: 245 cm

NB! Floor is an optional extra! 28 mm

OPTIONAL

Floor (outdoor/as terrace), floor (indoor), roofing felt (underlayer): 4 rolls, SBS roofing material: 4 rolls, roofing nails, EPDM, rain gutters.



Can be built in reverse!

PALMAKO CONNECT LENNA SET 303 8,3 m²

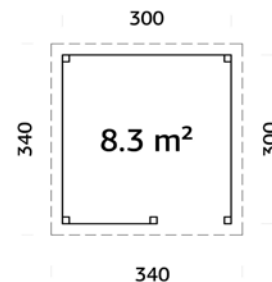

Strong posts from laminated wood.
Wall components are interchangeable.
Open wall solution.

MODEL SPECIFICATIONS

See page 232.



Can be built in reverse!

TREATMENT

Available dipped

Available painted

OPTIONAL

Floor (outdoor/as terrace), floor (indoor), roofing felt (underlayer): 2 rolls, SBS roofing material: 2 rolls, roofing nails, EPDM, rain gutters.

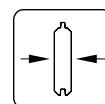

28 mm

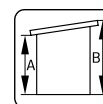

A: 210 cm
B: 245 cm

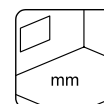

NB! Floor is an optional extra! 28 mm

PALMAKO CONNECT LENNA SET 310 16,6 m²

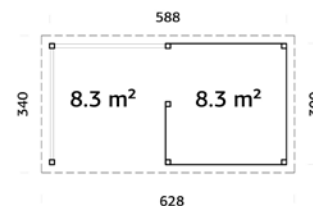

Strong posts from laminated wood.
Wall components are interchangeable.
Open wall solution.

MODEL SPECIFICATIONS

See page 232.



Can be built in reverse!

TREATMENT

Available dipped

Available painted

OPTIONAL

Floor (outdoor/as terrace), floor (indoor), roofing felt (underlayer): 4 rolls, SBS roofing material: 4 rolls, roofing nails, EPDM, rain gutters.

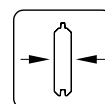

28 mm

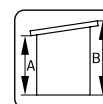

A: 210 cm
B: 245 cm

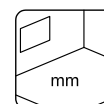

NB! Floor is an optional extra! 28 mm



Lenna 8,3 m² Set 303



Lenna 16,6 m² Set 309



Lenna 16,6 m² Set 404 Slide



Lenna 16,6 m² Set 404 Slide interior view



PALMAKO CONNECT LENNA 8,3 m²

SET 401 SLIDE / SET 701 SLIDE PLUS

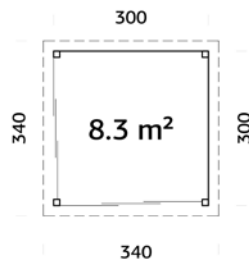

Sliding doors included.
Strong posts from laminated wood.
Wall components are interchangeable.

MODEL SPECIFICATIONS

See page 232.

TREATMENT

Available dipped

Available painted

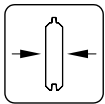

28 mm

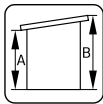

A: 210 cm
B: 245 cm

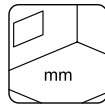

NB! Floor is an optional extra! 28 mm



Slide

Single glass, toughened, 4 mm



Slide Plus

Double glass, toughened, 4-16-4 mm

OPTIONAL

Floor (outdoor/as terrace), floor (indoor), roofing felt (underlayer): 2 rolls, SBS roofing material: 2 rolls, roofing nails, EPDM, rain gutters.

PALMAKO CONNECT LENNA 16,6 m²

SET 402 SLIDE / SET 702 SLIDE PLUS

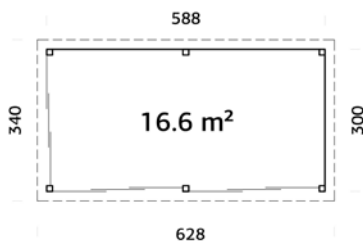

Sliding doors included.
Strong posts from laminated wood.
Wall components are interchangeable.

MODEL SPECIFICATIONS

See page 232.



Can be built in reverse!

TREATMENT

Available dipped

Available painted

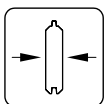

28 mm

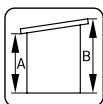

A: 210 cm
B: 245 cm

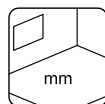

NB! Floor is an optional extra! 28 mm



Slide

Single glass, toughened, 4 mm



Slide Plus

Double glass, toughened, 4-16-4 mm

OPTIONAL

Floor (outdoor/as terrace), floor (indoor), roofing felt (underlayer): 4 rolls, SBS roofing material: 4 rolls, roofing nails, EPDM, rain gutters.

PALMAKO CONNECT LENNA 16,6 m² SET 403 SLIDE / SET 703 SLIDE PLUS

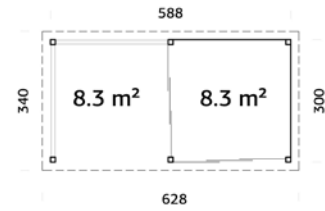

Sliding doors included.
Strong posts from laminated wood.
Wall components are interchangeable.

MODEL SPECIFICATIONS

See page 232.



Can be built in reverse!



Slide

Single glass, toughened, 4 mm



Slide Plus

Double glass, toughened, 4-16-4 mm

OPTIONAL

Floor (outdoor/as terrace), floor (indoor), roofing felt (underlayer): 4 rolls, SBS roofing material: 4 rolls, roofing nails, EPDM, rain gutters.

TREATMENT

Available dipped

Available painted

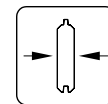

28 mm

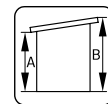

A: 210 cm
B: 245 cm

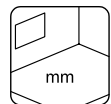

NB! Floor is an optional extra! 28 mm

PALMAKO CONNECT LENNA 16,6 m² SET 404 SLIDE / SET 704 SLIDE PLUS

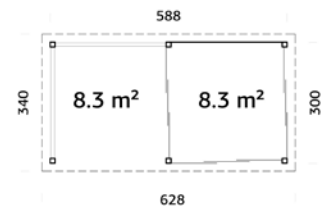

Sliding doors included.
Strong posts from laminated wood.
Wall components are interchangeable.

MODEL SPECIFICATIONS

See page 232.



Can be built in reverse!



Slide

Single glass, toughened, 4 mm



Slide Plus

Double glass, toughened, 4-16-4 mm

OPTIONAL

Floor (outdoor/as terrace), floor (indoor), roofing felt (underlayer): 4 rolls, SBS roofing material: 4 rolls, roofing nails, EPDM, rain gutters.

TREATMENT

Available dipped

Available painted

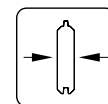

28 mm

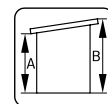

A: 210 cm
B: 245 cm

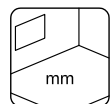

NB! Floor is an optional extra! 28 mm



PALMAKO CONNECT LENNA 16,6 m²

SET 405 SLIDE / SET 705 SLIDE PLUS

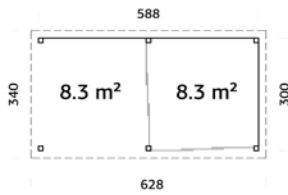

Sliding doors included.
Strong posts from laminated wood.
Wall components are interchangeable.

MODEL SPECIFICATIONS

See page 232.



Can be built in reverse!

TREATMENT

Available dipped

Available painted

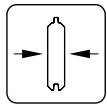

28 mm

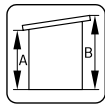

A: 210 cm
B: 245 cm

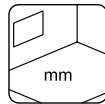

NB! Floor is an optional extra! 28 mm



Slide

Single glass, toughened, 4 mm



Slide Plus

Double glass, toughened, 4-16-4 mm

OPTIONAL

Floor (outdoor/as terrace), floor (indoor), roofing felt (underlayer): 4 rolls, SBS roofing material: 4 rolls, roofing nails, EPDM, rain gutters.

PALMAKO CONNECT LENNA 16,6 m²

SET 406 SLIDE / SET 706 SLIDE PLUS

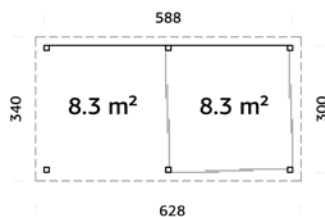

Sliding doors included.
Strong posts from laminated wood.
Wall components are interchangeable.

MODEL SPECIFICATIONS

See page 232.



Can be built in reverse!

TREATMENT

Available dipped

Available painted

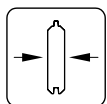

28 mm

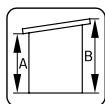

A: 210 cm
B: 245 cm

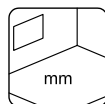

NB! Floor is an optional extra! 28 mm



Slide

Single glass, toughened, 4 mm



Slide Plus

Double glass, toughened, 4-16-4 mm

OPTIONAL

Floor (outdoor/as terrace), floor (indoor), roofing felt (underlayer): 4 rolls, SBS roofing material: 4 rolls, roofing nails, EPDM, rain gutters.

PALMAKO CONNECT LENNA 16,6 m²

SET 407 SLIDE / SET 707 SLIDE PLUS

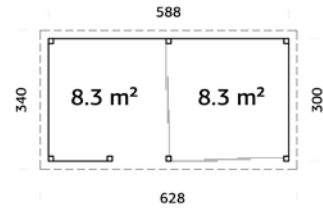

MODEL SPECIFICATIONS

See page 232.



Can be built in reverse!

Sliding doors included.
Strong posts from laminated wood.
Wall components are interchangeable.
Open wall solution.



Slide

Single glass, toughened, 4 mm



Slide Plus

Double glass, toughened, 4-16-4 mm

TREATMENT

Available dipped

Available painted

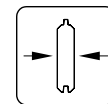

28 mm

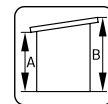

A: 210 cm
B: 245 cm

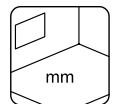

NB! Floor is an optional extra! 28 mm

OPTIONAL

Floor (outdoor/as terrace), floor (indoor), roofing felt (underlayer): 4 rolls, SBS roofing material: 4 rolls, roofing nails, EPDM, rain gutters.

PALMAKO CONNECT LENNA 16,6 m²

SET 408 SLIDE / SET 708 SLIDE PLUS

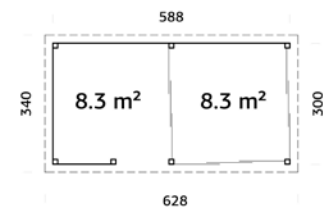

MODEL SPECIFICATIONS

See page 232.



Can be built in reverse!

Sliding doors included.
Strong posts from laminated wood.
Wall components are interchangeable.
Open wall solution.



Slide

Single glass, toughened, 4 mm



Slide Plus

Double glass, toughened, 4-16-4 mm

TREATMENT

Available dipped

Available painted

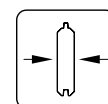

28 mm

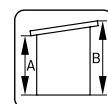

A: 210 cm
B: 245 cm

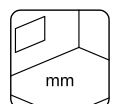

NB! Floor is an optional extra! 28 mm

OPTIONAL

Floor (outdoor/as terrace), floor (indoor), roofing felt (underlayer): 4 rolls, SBS roofing material: 4 rolls, roofing nails, EPDM, rain gutters.



PALMAKO CONNECT LENNA 24,9 m²

SET 411 SLIDE / SET 711 SLIDE PLUS

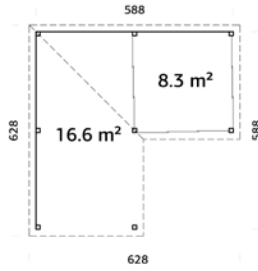

Sliding doors included.
Strong posts from laminated wood.
Wall components are interchangeable.

MODEL SPECIFICATIONS

See page 233.



Can be built in reverse!

TREATMENT

Available dipped
Available painted

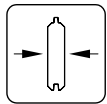

28 mm

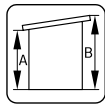

A: 210 cm
B: 245 cm

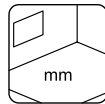

NB! Floor is an optional extra! 28 mm



Slide

Single glass, toughened, 4 mm



Slide Plus

Double glass, toughened, 4-16-4 mm

OPTIONAL

Floor (outdoor/as terrace), floor (indoor), roofing felt (underlayer): 9 rolls, SBS roofing material: 9 rolls, roofing nails, EPDM, rain gutters.

PALMAKO CONNECT LENNA 24,9 m²

SET 412 SLIDE / SET 712 SLIDE PLUS

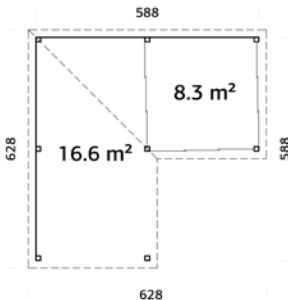

Sliding doors included.
Strong posts from laminated wood.
Wall components are interchangeable.

MODEL SPECIFICATIONS

See page 233.



Can be built in reverse!

TREATMENT

Available dipped
Available painted

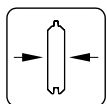

28 mm

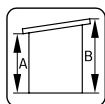

A: 210 cm
B: 245 cm

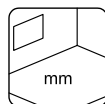

NB! Floor is an optional extra! 28 mm



Slide

Single glass, toughened, 4 mm



Slide Plus

Double glass, toughened, 4-16-4 mm

OPTIONAL

Floor (outdoor/as terrace), floor (indoor), roofing felt (underlayer): 9 rolls, SBS roofing material: 9 rolls, roofing nails, EPDM, rain gutters.

PALMAKO CONNECT LENNA 24,9 m² SET 409 SLIDE / SET 709 SLIDE PLUS

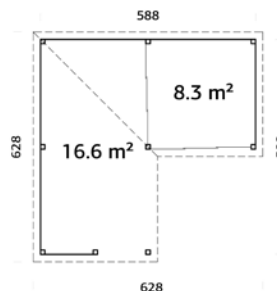

MODEL SPECIFICATIONS

See page 233.



Can be built in reverse!



Slide

Single glass, toughened, 4 mm



Slide Plus

Double glass, toughened, 4-16-4 mm

OPTIONAL

Floor (outdoor/as terrace), floor (indoor), roofing felt (underlayer): 9 rolls, SBS roofing material: 9 rolls, roofing nails, EPDM, rain gutters.

Sliding doors included.
Strong posts from laminated wood.
Wall components are interchangeable.
Open wall solution.

TREATMENT

- Available dipped
- Available painted

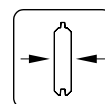

28 mm

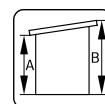

A: 210 cm
B: 245 cm

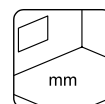

NB! Floor is an optional extra! 28 mm

PALMAKO CONNECT LENNA 24,9 m² SET 410 SLIDE / SET 710 SLIDE PLUS

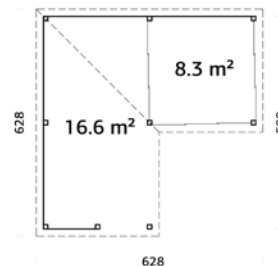

MODEL SPECIFICATIONS

See page 233.



Can be built in reverse!



Slide

Single glass, toughened, 4 mm



Slide Plus

Double glass, toughened, 4-16-4 mm

OPTIONAL

Floor (outdoor/as terrace), floor (indoor), roofing felt (underlayer): 9 rolls, SBS roofing material: 9 rolls, roofing nails, EPDM, rain gutters.

Sliding doors included.
Strong posts from laminated wood.
Wall components are interchangeable.
Open wall solution.

TREATMENT

- Available dipped
- Available painted

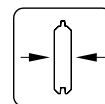

28 mm

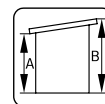

A: 210 cm
B: 245 cm

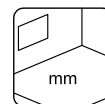

NB! Floor is an optional extra! 28 mm

PALMAKO CONNECT LENNA 24,9 m²

SET 422 SLIDE / SET 722 SLIDE PLUS

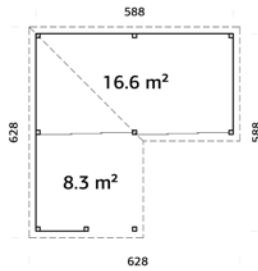

Sliding doors included.
Strong posts from laminated wood.
Wall components are interchangeable.
Open wall solution.

MODEL SPECIFICATIONS

See page 233.

TREATMENT

Available dipped
Available painted

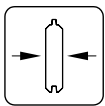

28 mm

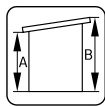

A: 210 cm
B: 245 cm

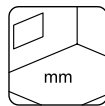

NB! Floor is an optional extra! 28 mm



Slide

Single glass, toughened, 4 mm



Slide Plus

Double glass, toughened, 4-16-4 mm



Can be built in reverse!

OPTIONAL

Floor (outdoor/as terrace), floor (indoor), roofing felt (underlayer): 9 rolls, SBS roofing material: 9 rolls, roofing nails, EPDM, rain gutters.

PALMAKO CONNECT LENNA 24,9 m²

SET 423 SLIDE / SET 723 SLIDE PLUS

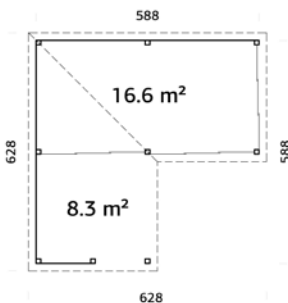

Sliding doors included.
Strong posts from laminated wood.
Wall components are interchangeable.
Open wall solution.

MODEL SPECIFICATIONS

See page 233.

TREATMENT

Available dipped
Available painted

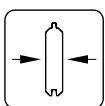

28 mm

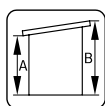

A: 210 cm
B: 245 cm

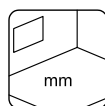

NB! Floor is an optional extra! 28 mm



Slide

Single glass, toughened, 4 mm



Slide Plus

Double glass, toughened, 4-16-4 mm



Can be built in reverse!

OPTIONAL

Floor (outdoor/as terrace), floor (indoor), roofing felt (underlayer): 9 rolls, SBS roofing material: 9 rolls, roofing nails, EPDM, rain gutters.

PALMAKO CONNECT LENNA 24,9 m² SET 413 SLIDE / SET 713 SLIDE PLUS

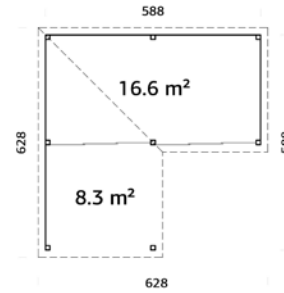

Sliding doors included.
Strong posts from laminated wood.
Wall components are interchangeable.

MODEL SPECIFICATIONS

See page 233.



Can be built in reverse!



Slide

Single glass, toughened, 4 mm



Slide Plus

Double glass, toughened, 4-16-4 mm

OPTIONAL

Floor (outdoor/as terrace), floor (indoor), roofing felt (underlayer): 9 rolls, SBS roofing material: 9 rolls, roofing nails, EPDM, rain gutters.

TREATMENT

Available dipped

Available painted

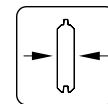

28 mm

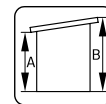

A: 210 cm
B: 245 cm

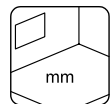

NB! Floor is an optional extra! 28 mm

PALMAKO CONNECT LENNA 24,9 m² SET 414 SLIDE / SET 714 SLIDE PLUS

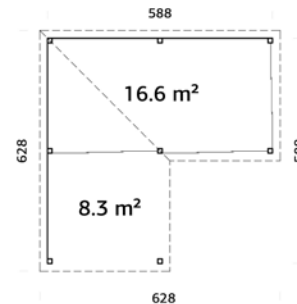

Sliding doors included.
Strong posts from laminated wood.
Wall components are interchangeable.

MODEL SPECIFICATIONS

See page 233.



Can be built in reverse!



Slide

Single glass, toughened, 4 mm



Slide Plus

Double glass, toughened, 4-16-4 mm

OPTIONAL

Floor (outdoor/as terrace), floor (indoor), roofing felt (underlayer): 9 rolls, SBS roofing material: 9 rolls, roofing nails, EPDM, rain gutters.

TREATMENT

Available dipped

Available painted

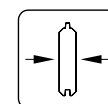

28 mm

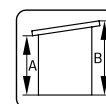

A: 210 cm
B: 245 cm

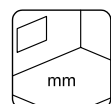

NB! Floor is an optional extra! 28 mm



Lenna 24,9 m² Set 422 Slide



Lenna 24,9 m² Set 422 Slide interior view

Lenna 24,9 m² Set 716 Slide Plus

PALMAKO CONNECT LENNA 24,9 m²

SET 415 SLIDE / SET 715 SLIDE PLUS

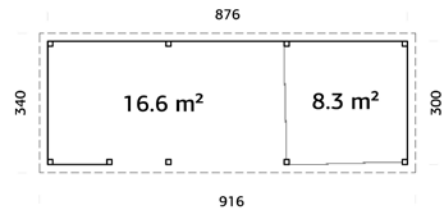

Sliding doors included.
Strong posts from laminated wood.
Wall components are interchangeable.
Open wall solution.

MODEL SPECIFICATIONS

See page 233.



Slide

Single glass, toughened, 4 mm



Slide Plus

Double glass, toughened, 4-16-4 mm



Can be built in reverse!

OPTIONAL

Floor (outdoor/as terrace), floor (indoor), roofing felt (underlayer): 4 rolls, SBS roofing material: 4 rolls, roofing nails, EPDM, rain gutters.

TREATMENT

Available dipped
Available painted

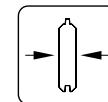

28 mm

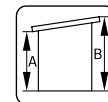

A: 210 cm
B: 245 cm

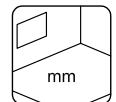

NB! Floor is an optional extra! 28 mm



PALMAKO CONNECT LENNA 24,9 m²

SET 416 SLIDE / SET 716 SLIDE PLUS

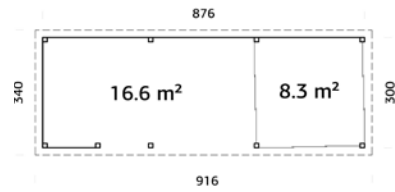

MODEL SPECIFICATIONS

See page 233.

Sliding doors included.
Strong posts from laminated wood.
Wall components are interchangeable.
Open wall solution.

TREATMENT

Available dipped
Available painted

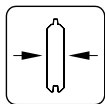

28 mm

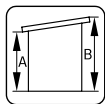

A: 210 cm
B: 245 cm

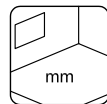

NB! Floor is an optional extra! 28 mm



Slide

Single glass, toughened, 4 mm



Slide Plus

Double glass, toughened, 4-16-4 mm



Can be built in reverse!

OPTIONAL

Floor (outdoor/as terrace), floor (indoor), roofing felt (underlayer): 4 rolls, SBS roofing material: 4 rolls, roofing nails, EPDM, rain gutters.

PALMAKO CONNECT LENNA 24,9 m²

SET 419 SLIDE / SET 719 SLIDE PLUS

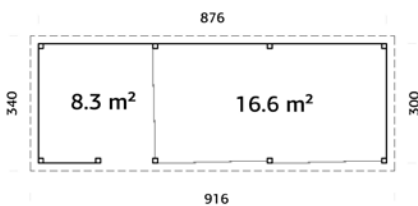

MODEL SPECIFICATIONS

See page 233.

Sliding doors included.
Strong posts from laminated wood.
Wall components are interchangeable.
Open wall solution.

TREATMENT

Available dipped
Available painted

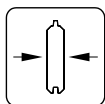

28 mm

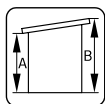

A: 210 cm
B: 245 cm

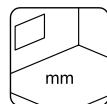

NB! Floor is an optional extra! 28 mm



Slide

Single glass, toughened, 4 mm



Slide Plus

Double glass, toughened, 4-16-4 mm



Can be built in reverse!

OPTIONAL

Floor (outdoor/as terrace), floor (indoor), roofing felt (underlayer): 4 rolls, SBS roofing material: 4 rolls, roofing nails, EPDM, rain gutters.

PALMAKO CONNECT LENNA 24,9 m²

SET 417 SLIDE / SET 717 SLIDE PLUS



PALMAKO CONNECT

196-255

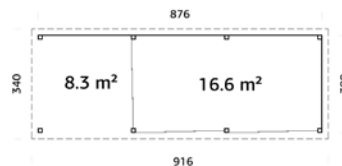

MODEL SPECIFICATIONS

See page 233.



Can be built in reverse!



Slide

Single glass, toughened, 4 mm



Slide Plus

Double glass, toughened, 4-16-4 mm

OPTIONAL

Floor (outdoor/as terrace), floor (indoor), roofing felt (underlayer): 4 rolls, SBS roofing material: 4 rolls, roofing nails, EPDM, rain gutters.

Sliding doors included.
Strong posts from laminated wood.
Wall components are interchangeable.

TREATMENT

- Available dipped
- Available painted

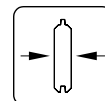

28 mm

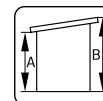

A: 210 cm
B: 245 cm

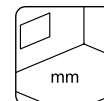

NB! Floor is an optional extra! 28 mm

PALMAKO CONNECT LENNA 24,9 m²

SET 418 SLIDE / SET 718 SLIDE PLUS

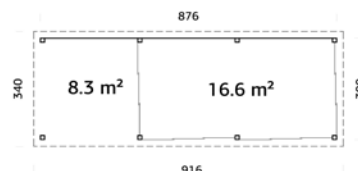

MODEL SPECIFICATIONS

See page 233.



Can be built in reverse!



Slide

Single glass, toughened, 4 mm



Slide Plus

Double glass, toughened, 4-16-4 mm

OPTIONAL

Floor (outdoor/as terrace), floor (indoor), roofing felt (underlayer): 4 rolls, SBS roofing material: 4 rolls, roofing nails, EPDM, rain gutters.

Sliding doors included.
Strong posts from laminated wood.
Wall components are interchangeable.

TREATMENT

- Available dipped
- Available painted

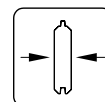

28 mm

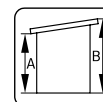

A: 210 cm
B: 245 cm

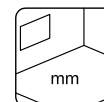

NB! Floor is an optional extra! 28 mm



PALMAKO CONNECT LENNA 33,2 m²

SET 420 SLIDE / SET 720 SLIDE PLUS

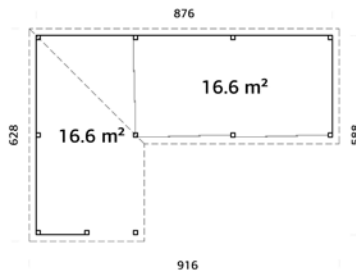

Sliding doors included.
Strong posts from laminated wood.
Wall components are interchangeable.
Open wall solution.

MODEL SPECIFICATIONS

See page 233.



Can be built in reverse!

TREATMENT

Available dipped
Available painted

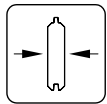

28 mm

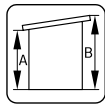

A: 210 cm
B: 245 cm

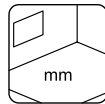

NB! Floor is an optional extra! 28 mm



Slide

Single glass, toughened, 4 mm



Slide Plus

Double glass, toughened, 4-16-4 mm

OPTIONAL

Floor (outdoor/as terrace), floor (indoor), roofing felt (underlayer): 14 rolls, SBS roofing material: 14 rolls, roofing nails, EPDM, rain gutters.

PALMAKO CONNECT LENNA 33,2 m²

SET 421 SLIDE / SET 721 SLIDE PLUS

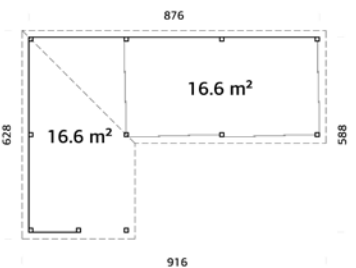

Sliding doors included.
Strong posts from laminated wood.
Wall components are interchangeable.
Open wall solution.

MODEL SPECIFICATIONS

See page 233.



Can be built in reverse!

TREATMENT

Available dipped
Available painted

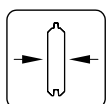

28 mm

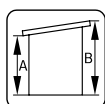

A: 210 cm
B: 245 cm

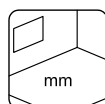

NB! Floor is an optional extra! 28 mm



Slide

Single glass, toughened, 4 mm



Slide Plus

Double glass, toughened, 4-16-4 mm

OPTIONAL

Floor (outdoor/as terrace), floor (indoor), roofing felt (underlayer): 14 rolls, SBS roofing material: 14 rolls, roofing nails, EPDM, rain gutters.

PALMAKO CONNECT LENNA KIOSK SET 304 8,3 m²



Strong posts from laminated wood.
Wall components are interchangeable.

MODEL SPECIFICATIONS

See page 232.

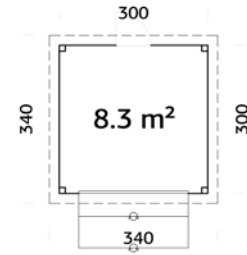

TREATMENT

- Available dipped
- Available painted

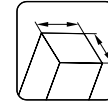

120x120 mm

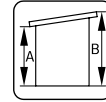

A: 210 cm
B: 245 cm

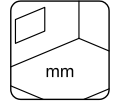

NB! Floor is an optional extra! 28 mm

OPTIONAL

Floor (outdoor/as terrace), floor (indoor), roofing felt (underlayer): 2 rolls, SBS roofing material: 2 rolls, roofing nails, EPDM, rain gutters.

PALMAKO CONNECT LENNA KIOSK SET 305 8,3 m²



Strong posts from laminated wood.
Wall components are interchangeable.

MODEL SPECIFICATIONS

See page 232.

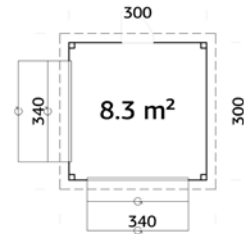

TREATMENT

- Available dipped
- Available painted

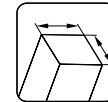

120x120 mm

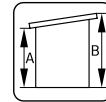

A: 210 cm
B: 245 cm

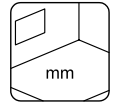

NB! Floor is an optional extra! 28 mm

OPTIONAL

Floor (outdoor/as terrace), floor (indoor), roofing felt (underlayer): 2 rolls, SBS roofing material: 2 rolls, roofing nails, EPDM, rain gutters.

PALMAKO CONNECT LENNA KIOSK SET 306 8,3 m²



Strong posts from laminated wood.
Wall components are interchangeable.

MODEL SPECIFICATIONS

See page 232.

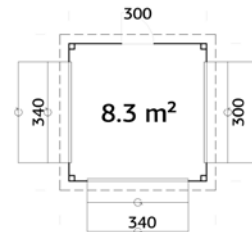

TREATMENT

- Available dipped
- Available painted

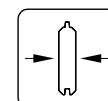

28 mm

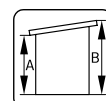

A: 210 cm
B: 245 cm

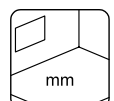

NB! Floor is an optional extra! 28 mm

OPTIONAL

Floor (outdoor/as terrace), floor (indoor), roofing felt (underlayer): 2 rolls, SBS roofing material: 2 rolls, roofing nails, EPDM, rain gutters.

PALMAKO CONNECT LENNA KIOSK SET 311 16,6 m²

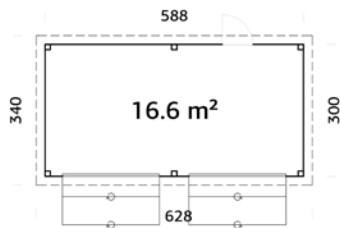

Strong posts from laminated wood.
Wall components are interchangeable.

TREATMENT

- Available dipped
- Available painted

MODEL SPECIFICATIONS

See page 232.

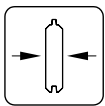

28 mm

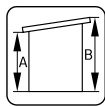

A: 210 cm
B: 245 cm

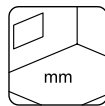

NB! Floor is an optional extra! 28 mm

OPTIONAL

Floor (outdoor/as terrace), floor (indoor), roofing felt (underlayer): 4 rolls, SBS roofing material: 4 rolls, roofing nails, EPDM, rain gutters.

PALMAKO CONNECT LENNA KIOSK SET 312 16,6 m²

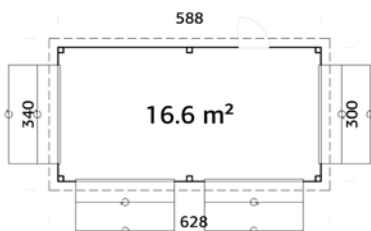

Strong posts from laminated wood.
Wall components are interchangeable.

TREATMENT

- Available dipped
- Available painted

MODEL SPECIFICATIONS

See page 232.

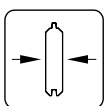

28 mm

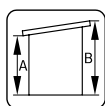

A: 210 cm
B: 245 cm

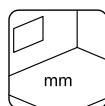

NB! Floor is an optional extra! 28 mm

OPTIONAL

Floor (outdoor/as terrace), floor (indoor), roofing felt (underlayer): 4 rolls, SBS roofing material: 4 rolls, roofing nails, EPDM, rain gutters.

OPTIONAL PRODUCTS

SEE OPTIONAL PRODUCTS, PAGES 344-368

House	Art. No.	Lenma extra roof	Full wall	Louvre wall	Wall with hatch	Half-wall corner	Fence	Floor ¹ (indoor)	Floor ² (outdoor/ as terrace)	Roofing felt (underlayer), rolls	SBS roofing material, rolls	Roofing nails, 1 kg	EPDM	Rain gutters
Lenma extra roof 8,3 m ²	110797							109811	103090	2 rolls	2 rolls	107950	2x 111847	106626
Lenma 8,3 m ²	110544	110797	109375	110536	110786	109805	109378	109811	103090	2 rolls	2 rolls	107950	2x 111847	106627
Lenma 16,6 m ²	110850	110797	109375	110536	110786	109805	109378	109811	103090	4 rolls	4 rolls	107950	2x 111847	106626+106627
Lenma 24,9 m ²	110540	110797	109375	110536	110786	109805	109378	109811	103090	9 rolls	9 rolls	107950	3x 111847	2x 106626, 2x 106627
Lenma Set 301 8,3 m ²	111286							103090	103090	2 rolls	2 rolls	107950	2x 111847	106627
Lenma Set 307 16,6 m ²	111336							103090	103090	4 rolls	4 rolls	107950	2x 111847	106626+106627
Lenma Set 308 16,6 m ²	111340							103090	103090	4 rolls	4 rolls	107950	2x 111847	106626+106627
Lenma Set 302 8,3 m ²	111290							103090	103090	2 rolls	2 rolls	107950	2x 111847	106627
Lenma Set 309 16,6 m ²	111344							103090	103090	4 rolls	4 rolls	107950	2x 111847	106626+106627
Lenma Set 303 8,3 m ²	111294							103090	103090	2 rolls	2 rolls	107950	2x 111847	106627
Lenma Set 310 16,6 m ²	111348							103090	103090	4 rolls	4 rolls	107950	2x 111847	106626+106627
Lenma 8,3 m ² Set 401 Slide / Set 701 Slide Plus	111401 / 112093							109811		2 rolls	2 rolls	107950	2x 111847	106627
Lenma 16,6 m ² Set 402 Slide / Set 702 Slide Plus	111371 / 112089							109811		4 rolls	4 rolls	107950	2x 111847	106626+106627
Lenma 16,6 m ² Set 403 Slide / Set 703 Slide Plus	111375 / 112085							109811	103090	4 rolls	4 rolls	107950	2x 111847	106626+106627
Lenma 16,6 m ² Set 404 Slide / Set 704 Slide Plus	111579 / 112081							109811	103090	4 rolls	4 rolls	107950	2x 111847	106626+106627
Lenma 16,6 m ² Set 405 Slide / Set 705 Slide Plus	111405 / 112077							109811	103090	4 rolls	4 rolls	107950	2x 111847	106626+106627
Lenma 16,6 m ² Set 406 Slide / Set 706 Slide Plus	111409 / 112073							109811	103090	4 rolls	4 rolls	107950	2x 111847	106626+106627
Lenma 16,6 m ² Set 407 Slide / Set 707 Slide Plus	111413 / 112069							109811	103090	4 rolls	4 rolls	107950	2x 111847	106626+106627
Lenma 16,6 m ² Set 408 Slide / Set 708 Slide Plus	111417 / 112065							109811	103090	4 rolls	4 rolls	107950	2x 111847	106626+106627
Lenma 24,9 m ² Set 411 Slide / Set 711 Slide Plus	111554 / 112053							109811	103090	9 rolls	9 rolls	107950	3x 111847	2x 106626, 2x 106627

¹ Includes treated joists. ² Floor boards are pressure-treated and floor joists are treated. One floor set is suitable for 8,3 m². The article number is indicated to untreated items, for treated items ask our sales team.

OPTIONAL PRODUCTS

SEE OPTIONAL PRODUCTS, PAGES 344-368

House	Art. No.	Lenna extra roof	Full wall	Louvre wall	Wall with hatch	Half-wall corner	Fence	Floor ¹ (indoor)	Floor ² (outdoor/ as terrace)	Roofing felt (underlayer), rolls	SBS roofing material, rolls	Roofing nails, EPDM	Rain gutters
Lenna 24.9 m ² Set 412 Slide / Set 712 Slide Plus	111558 / 112049												
Lenna 24.9 m ² Set 409 Slide / Set 709 Slide Plus	111546 / 112061							109811	105090	9 rolls	9 rolls	3x 111847	2x 106626, 2x 106627
Lenna 24.9 m ² Set 410 Slide / Set 710 Slide Plus	111550 / 112057							109811	105090	9 rolls	9 rolls	3x 111847	2x 106626, 2x 106627
Lenna 24.9 m ² Set 422 Slide / Set 722 Slide Plus	111594 / 112009							109811	105090	9 rolls	9 rolls	3x 111847	2x 106626, 2x 106627
Lenna 24.9 m ² Set 423 Slide / Set 723 Slide Plus	111598 / 112005							109811	105090	9 rolls	9 rolls	3x 111847	2x 106626, 2x 106627
Lenna 24.9 m ² Set 413 Slide / Set 713 Slide Plus	111562 / 112045							109811	105090	9 rolls	9 rolls	3x 111847	2x 106626, 2x 106627
Lenna 24.9 m ² Set 414 Slide / Set 714 Slide Plus	111319 / 112041							109811	105090	9 rolls	9 rolls	3x 111847	2x 106626, 2x 106627
Lenna 24.9 m ² Set 415 Slide / Set 715 Slide Plus	111566 / 112037							109811	105090	4 rolls	4 rolls	3x 111847	2x 107375
Lenna 24.9 m ² Set 416 Slide / Set 716 Slide Plus	111570 / 112033							109811	105090	4 rolls	4 rolls	3x 111847	2x 107375
Lenna 24.9 m ² Set 419 Slide / Set 719 Slide Plus	111582 / 112021							109811	105090	4 rolls	4 rolls	3x 111847	2x 107375
Lenna 24.9 m ² Set 417 Slide / Set 717 Slide Plus	111574 / 112029							109811	105090	4 rolls	4 rolls	3x 111847	2x 107375
Lenna 24.9 m ² Set 418 Slide / Set 718 Slide Plus	111578 / 112025							109811	105090	4 rolls	4 rolls	3x 111847	2x 107375
Lenna 33.2 m ² Set 420 Slide / Set 720 Slide Plus	111586 / 112017							109811	103090	14 rolls	14 rolls	4x 111847	106626+106627, 2x 107375
Lenna 33.2 m ² Set 421 Slide / Set 721 Slide Plus	111590 / 112013							109811	103090	14 rolls	14 rolls	4x 111847	106626+106627, 2x 107375
Lenna Kiosk Set 304 8.3 m ²	111298							109811	103090	2 rolls	2 rolls	2x 111847	106627
Lenna Kiosk Set 305 8.3 m ²	111328							109811	103090	2 rolls	2 rolls	2x 111847	106627
Lenna Kiosk Set 306 8.3 m ²	111332							109811	103090	2 rolls	2 rolls	2x 111847	106627
Lenna Kiosk Set 311 16.6 m ²	111352							109811	103090	4 rolls	4 rolls	2x 111847	106626+106627
Lenna Kiosk Set 312 16.6 m ²	111356							109811	103090	4 rolls	4 rolls	2x 111847	106626+106627

¹ Includes treated joists. ² Floor boards are pressure-treated and floor joists are treated. One floor set is suitable for 8.3 m². The article number is indicated to untreated items, for treated items ask our sales team.



Roger 19,0+33,2 m² with sectional door



GARAGES



PALMAKO GARAGE
RASMUS 19,0 m²
KIT WITHOUT DOOR



PALMAKO GARAGE
RASMUS 19,0 m²
WITH WOODEN GATE



PALMAKO GARAGE
RASMUS 19,0 m²
WITH SECTIONAL DOOR



PALMAKO GARAGE
ROGER 19,0 m²
KIT WITHOUT DOOR



PALMAKO GARAGE
ROGER 19,0 m²
WITH WOODEN GATE



PALMAKO GARAGE
ROGER 19,0 m²
WITH SECTIONAL DOOR



PALMAKO GARAGE
ROGER 23,9 m²
KIT WITHOUT DOOR



PALMAKO GARAGE
ROGER 23,9 m²
WITH WOODEN GATE



PALMAKO GARAGE
ROGER 23,9 m²
WITH SECTIONAL DOOR



PALMAKO GARAGE
ROGER 27,7 m²
KIT WITHOUT DOOR



PALMAKO GARAGE
ROGER 27,7 m²
WITH WOODEN GATE



PALMAKO GARAGE
ROGER 27,7 m²
WITH SECTIONAL DOOR



PALMAKO GARAGE
ROGER 21,9+5,2 m²
KIT WITHOUT DOOR



PALMAKO GARAGE
ROGER 21,9+5,2 m²
WITH WOODEN GATE



PALMAKO GARAGE
ROGER 21,9+5,2 m²
WITH SECTIONAL DOOR



PALMAKO GARAGE
ROGER 28,4 m²
KIT WITHOUT DOOR



PALMAKO GARAGE
ROGER 28,4 m²
WITH WOODEN GATE



PALMAKO GARAGE
ROGER 28,4 m²
WITH SECTIONAL DOOR

NEW



PALMAKO GARAGE
ROGER 19,0+16,2 m²
KIT WITHOUT DOOR



PALMAKO GARAGE
ROGER 19,0+16,2 m²
WITH WOODEN GATE



PALMAKO GARAGE
ROGER 19,0+16,2 m²
WITH SECTIONAL DOOR

NEW

NEW

NEW

NEW

NEW



PALMAKO GARAGE
ROGER 19,0+33,2 m²
KIT WITHOUT DOOR



PALMAKO GARAGE
ROGER 19,0+33,2 m²
WITH WOODEN GATE



PALMAKO GARAGE
ROGER 19,0+33,2 m²
WITH SECTIONAL DOOR



PALMAKO NORDIC+ GARAGE
ANDRE 21,5 m²
KIT WITHOUT DOOR



PALMAKO NORDIC+ GARAGE
ANDRE 21,5 m²
WITH SECTIONAL DOOR



PALMAKO NORDIC+ GARAGE
ANDRE 28,5 m²
KIT WITHOUT DOOR



PALMAKO NORDIC+ GARAGE
ANDRE 28,5 m²
WITH SECTIONAL DOOR



PALMAKO NORDIC+ GARAGE
ANDRE 44,7 m²
KIT WITHOUT DOOR



PALMAKO NORDIC+ GARAGE
ANDRE 44,7 m²
WITH SECTIONAL DOOR

ENGINE SET FOR GARAGE SECTIONAL DOOR



MODEL SPECIFICATIONS

Motor measures: 600x250x350 mm

Rail measures: 3000x50x100 mm

Weight: 10+5 kg

GARAGE

Engine Set

Roger 19,0 m ² with sectional door	108561
Roger 23,9 m ² with sectional door	108561
Roger 27,7 m ² with sectional door	108561
Roger 21,9+5,2 m ² with sectional door	108561
Roger 28,4 m ² with sectional door	108561
Roger 19,0+16,2 m ² with sectional door	108561
Roger 19,0+33,2 m ² with sectional door	108561
Andre 21,5 m ² with sectional door	108561
Andre 28,5 m ² with sectional door	108561
Andre 44,7 m ² with sectional door	108561

The set includes two remote controls.
Depending on the model of the garage,
additional accessories may be required
for installation.

Electrical connection required!

PALMAKO GARAGE RASMUS 19,0 m² WITH WOODEN GATE



PALMAKO GARAGES
256-273



Rasmus 19,0 m² kit without door



Rasmus 19,0 m² with sectional door
Sectional door opening measurements:
221x188 cm

MODEL SPECIFICATIONS

Log measurements: 380x570 cm

Volume: 44,5 m³

Door/window type: Garden

Door/window glass:

Real glass, 4 mm

Window opening

measurements: 70x43 cm

Door opening

measurements: 73x183 cm

Wooden gate opening

measurements: 225x194 cm

Art. No. Wooden gate: 103555

Roof boards: 19 mm

Roof area: 24,5 m²

Roof gradient: 1,8°

Gross ground area: 19,8 m²

OPTIONAL

Roofing felt (underlayer): 6 rolls, SBS roofing material: 6 rolls, EPDM, roofing nails, rain gutters, extension, canopy roof, additional door and window.

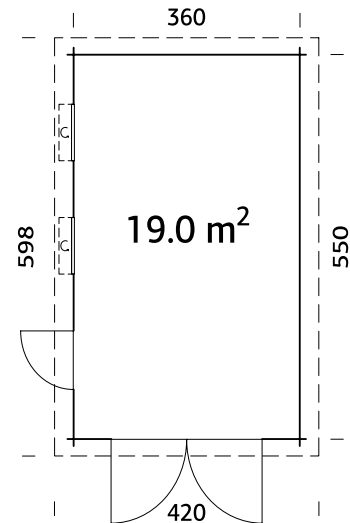

Strong purlins from laminated wood.
Matt door and window glass.

TREATMENT

Available painted

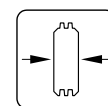

44 mm

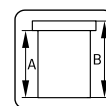

A: 228 cm
B: 253 cm

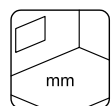

-

PALMAKO GARAGE ROGER 19,0 m² WITH WOODEN GATE



Roger 19,0 m² kit without door



Roger 19,0 m² with sectional door
Sectional door opening
measurements: 221x188 cm



Engine set for
garage sectional
door as an optional
extra

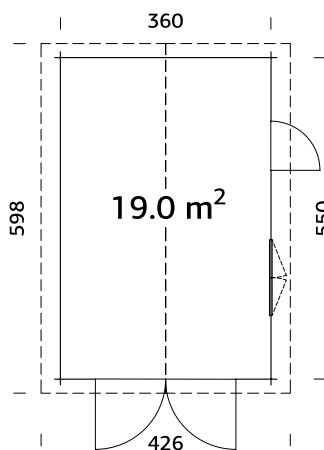

MODEL SPECIFICATIONS

Log measurements: 380x570 cm

Volume: 45,9 m³

Door/window type: Garden+

Door/window glass:
Double glass, 3-6-3 mm

**Window opening
measurements:** 119x89 cm

**Door opening
measurements:** 73x175 cm

Wooden gate opening

measurements: 225x194 cm

Art. No. Wooden gate: 103555

Roof boards: 19 mm

Roof area: 25,4 m²

Roof gradient: 16,3°

Gross ground area: 19,8 m²

OPTIONAL

Roofing felt (underlayer): 6 rolls, SBS roofing material: 6 rolls, shingles: 10 packs, roofing nails, rain gutters, extension, canopy roof, additional door and window, engine set for garage sectional door.

Double glazed.

Strong purlins from laminated wood.

TREATMENT

Available dipped

Available painted

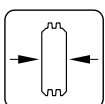

44 mm

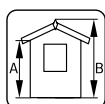

A: 217 cm
B: 276 cm

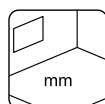

-

PALMAKO GARAGE ROGER 23,9 m² WITH WOODEN GATE



PALMAKO GARAGES
256-273



Roger 23,9 m² kit without door



Roger 23,9 m² with sectional door
Sectional door opening
measurements: 221x188 cm

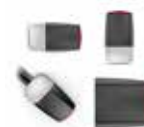

Engine set for
garage sectional
door as an optional
extra

MODEL SPECIFICATIONS

Log measurements: 470x570 cm

Volume: 59,0 m³

Door/window type: Garden+

Door/window glass:

Double glass, 3-6-3 mm

Window opening

measurements: 119x89 cm

Door opening

measurements: 73x175 cm

Wooden gate opening

measurements: 225x194 cm

Art. No. Wooden gate: 103555

Roof boards: 19 mm

Roof area: 31,7 m²

Roof gradient: 15,7°

Gross ground area: 24,8 m²

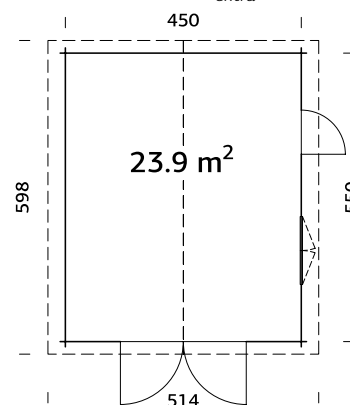

Double glazed.

Strong purlins from laminated wood.

OPTIONAL

Roofing felt (underlayer): 7 rolls, SBS roofing material: 7 rolls, shingles: 12 packs, roofing nails, rain gutters, extension, canopy roof, additional door and window, engine set for garage sectional door.

TREATMENT

Available dipped

Available painted

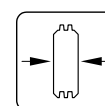

44 mm

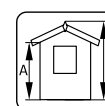

A: 217 cm
B: 287 cm

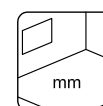

-

PALMAKO GARAGE ROGER 27,7 m² WITH WOODEN GATE



Roger 27,7 m² kit without door



Roger 27,7 m² with sectional door
Sectional door opening
measurements: 221x188 cm



Engine set for
garage sectional
door as an optional
extra

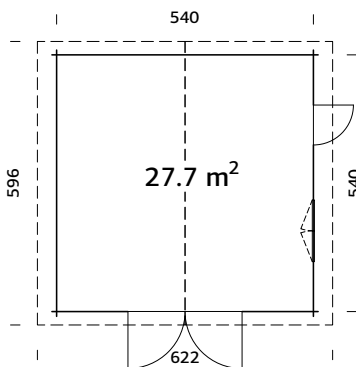

MODEL SPECIFICATIONS

Log measurements: 560x560 cm

Volume: 73,9 m³

Door/window type: Summer

Door/window glass:

Double glass, 3-9-3 mm

**Window opening
measurements:** 117x92 cm

**Door opening
measurements:** 73x183 cm

Wooden gate opening

measurements: 225x194 cm

Art. No. Wooden gate: 103587

Roof boards: 19 mm

Roof area: 37,8 m²

Roof gradient: 15,7°

Gross ground area: 29,2 m²

OPTIONAL

Roofing felt (underlayer): 8 rolls, SBS roofing material: 8 rolls, shingles: 14 packs, roofing nails, rain gutters, extension, canopy roof, additional door and window, engine set for garage sectional door.

Double glazed.

Strong purlins from laminated wood.

TREATMENT

Available dipped

Available painted

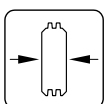

70 mm

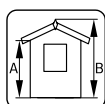

A: 230 cm
B: 312 cm

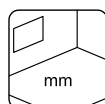

-

PALMAKO GARAGE ROGER 21,9+5,2 m² WITH WOODEN GATE



PALMAKO GARAGES
256-273



Roger 21,9+5,2 m² kit without door



Roger 21,9+5,2 m² with sectional door
Sectional door opening measurements:
221x188 cm



Engine set for garage sectional door as an optional extra

MODEL SPECIFICATIONS

Log measurements: 530x570 cm

Volume: 60,0 m³

Door/window type: Garden+

Door/window glass:

Double glass, 3-6-3 mm

Window opening measurements: 78x89 cm

Door opening

measurements: 73x175 cm

Wooden gate opening

measurements: 225x194 cm

Art. No. Wooden gate: 103555

Roof boards: 19 mm

Roof area: 35,4 m²

Roof gradient: 18,7°

Gross ground area: 28,1 m²

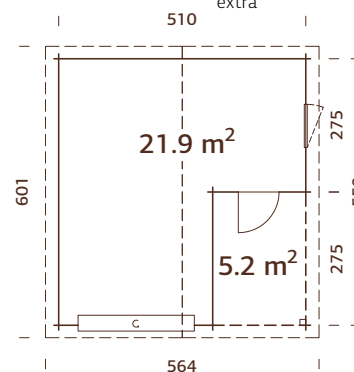

OPTIONAL

Roofing felt (underlayer): 7 rolls, SBS roofing material: 7 rolls, shingles: 14 packs, roofing nails, rain gutters, extension, canopy roof, additional door and window, engine set for garage sectional door.

Double glazed.

Strong purlins

from laminated wood.

Can be built in reverse!



TREATMENT

Available dipped

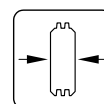

44 mm

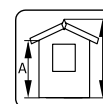

A: 228 cm
B: 321 cm

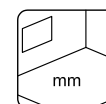

-

PALMAKO GARAGE ROGER 28,4 m² WITH WOODEN GATE



PALMAKO GARAGES
256-273



Roger 28,4 m² kit without door



Roger 28,4 m² with sectional door
Sectional door opening measurements:
221x188 cm



Engine set for garage sectional door as an optional extra

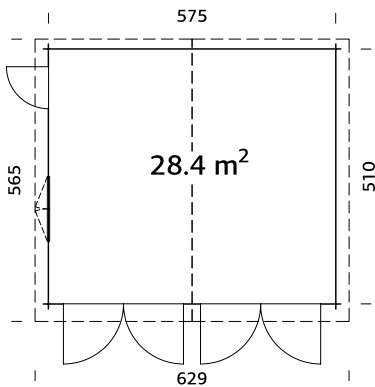

MODEL SPECIFICATIONS

Log measurements: 595x530 cm

Volume: 73,5 m³

Door/window type: Garden+

Door/window glass:

Double glass, 3-6-3 mm

Window opening

measurements: 119x89 cm

Door opening

measurements: 73x175 cm

Wooden gate opening

measurements: 225x194 cm

Art. No. Wooden gate: 103555

Roof boards: 19 mm

Roof area: 36,8 m²

Roof gradient: 16,8°

Gross ground area: 29,3 m²

OPTIONAL

Roofing felt (underlayer): 9 rolls, SBS roofing material: 9 rolls, shingles: 14 packs, roofing nails, rain gutters, extension, canopy roof, additional door and window, engine set for garage sectional door.

Double glazed.

Strong purlins from laminated wood.

TREATMENT

Available dipped

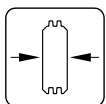

44 mm

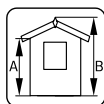

A: 217 cm
B: 310 cm

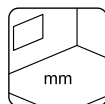

-

PALMAKO GARAGE ROGER 19,0+16,2 m² WITH WOODEN GATE



NEW!



Roger 19,0+16,2 m² kit without door



Roger 19,0+16,2 m² with sectional door
Sectional door opening measurements:
221x188 cm



Engine set for garage sectional door as an optional extra

MODEL SPECIFICATIONS

Log measurements: 673x570 cm

Volume: 46,0+44,0 m³

Door/window type: Garden+

Door/window glass:

Double glass, 3-6-3 mm

Window opening measurements: 119x89 cm

Door opening

measurements: 73x175 cm

Wooden gate opening

measurements: 225x194 cm

Art. No. Wooden gate: 103555

Roof boards: 19 mm

Roof area: 45,0 m²

Roof gradient: 17,4°

Gross ground area: 36,5 m²

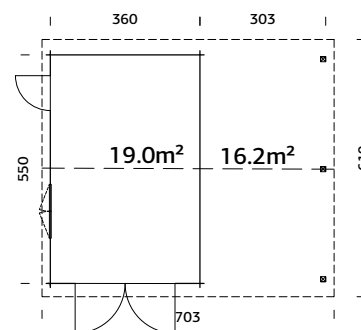

OPTIONAL

Roofing felt (underlayer): 8 rolls, SBS roofing material: 8 rolls, shingles: 18 packs, roofing nails, rain gutters, additional door and window, engine set for garage sectional door.

Double glazed.

Strong purlins

from laminated wood.

Can be built in reverse!



TREATMENT

Available dipped

Available painted

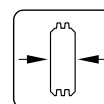

44 mm

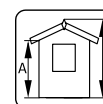

A: 222 cm
B: 316 cm

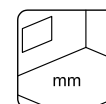

-

PALMAKO GARAGE ROGER 19,0+33,2 m² WITH WOODEN GATE



NEW!



PALMAKO GARAGES
256-273



Roger 19,0+33,2 m² kit without door



Roger 19,0+33,2 m² with sectional door
Sectional door opening measurements:
221x188 cm



Engine set for garage sectional door as an optional extra

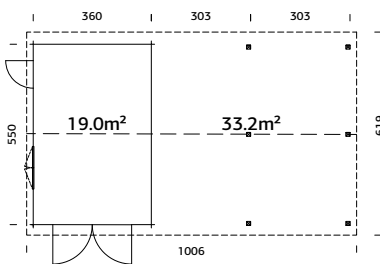

MODEL SPECIFICATIONS

Log measurements: 976x570 cm

Volume: 46,0+88,0 m³

Door/window type: Garden+

Door/window glass:

Double glass, 3-6-3 mm

Window opening

measurements: 119x89 cm

Door opening

measurements: 73x175 cm

Wooden gate opening

measurements: 225x194 cm

Art. No. Wooden gate: 103555

Roof boards: 19 mm

Roof area: 36,8 m²

Roof gradient: 17,4°

Gross ground area: 53,1 m²

OPTIONAL

Roofing felt (underlayer): 10 rolls, SBS roofing material: 10 rolls, shingles: 24 packs, roofing nails, rain gutters, additional door and window, engine set for garage sectional door.



Double glazed.

Can be built in reverse!

Strong purlins from laminated wood

TREATMENT

Available dipped

Available painted

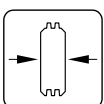

44 mm

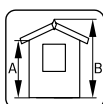

A: 222 cm
B: 316 cm

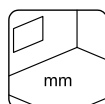

PRE-FABRICATED PALMAKO NORDIC+ GARAGES WITH ELEMENT THICKNESS OF 160 MM

These Scandinavian-style garages are suitable for any garden that lacks strong, weather-resistant buildings where to park your car. Feel free to take your time and delve into the following pages of our best choice of modern, pre-fabricated Nordic+ garages.

Ready-made wall elements are covered with wind-protection plastic inside, making these garages extremely weatherproof, especially rain and wind-resistant. It is comfortable to be in a building when it is warm - we have thought about it and given you an opportunity for 95 mm insulation. You can insulate walls, floors and ceilings. For better ventilation we have added ventilation battens after cladding. All the garages have double thermo glazing and outwards-opening windows. These models have 40 mm EPS (expanded polystyrene) insulated doors.



Total element thickness by Nordic+ garages is 160 mm. Here is a cross section of an element just to get a better understanding of what these elements look like and consist of:

1. 44x95mm frame
2. Wind-protection plastic
3. 19x45mm ventilation battens
4. 28x70mm cladding support battens
5. 18mm fine sawn cladding

One set – many houses!

A model contains set of wall and window-door elements, which can be rearranged in several ways. This results in multiple appearance options for the house.

NORDIC+ GARAGE ANDRE 28.5 m² WITH SECTIONAL DOOR



ANDRE OPTION 1



ANDRE OPTION 2



ANDRE OPTION 3



ANDRE OPTION 4



PALMAKO NORDIC+ GARAGES MODULE DESIGN

PALMAKO NORDIC+ GARAGE ANDRE 21,5 m²

WITH SECTIONAL DOOR



PALMAKO GARAGES
256-273



Andre 21,5 m² kit without door



Engine set for garage sectional door as an optional extra

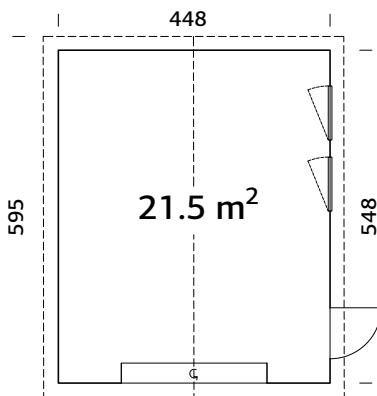

MODEL SPECIFICATIONS

Wall measurements: 448x548 cm

Volume: 55,4 m³

Door/window type: Summer

Door glass:

Double glass, 4-9-4 mm

Window glass:

Double glass, 3-9-3 mm

Window opening

measurements: 69x38 cm

Door opening measurements:

78x191, 221x188 cm

Door sill: hard wood

Roof boards: 19 mm

Roof area: 30,4 m²

Roof gradient: 20,0°

Gross ground area: 24,6 m²

Door and window elements are interchangeable.

Double glazed.

Trendy look! Fine-sawn cladding.

Ready-made wall elements with wind protection plastic!

Sectional door included.

OPTIONAL

Roofing felt (underlayer): 7 rolls, SBS roofing material: 7 rolls, shingles: 13 packs, roofing nails, rain gutters, additional door and window, canopy roof, engine set for garage sectional door.

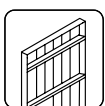

160 mm

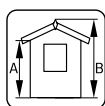

A: 216 cm
B: 316 cm

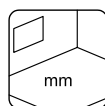

-

PALMAKO NORDIC+ GARAGE ANDRE 28,5 m²

WITH SECTIONAL DOOR



Andre 28,5 m² kit without door



Engine set for garage sectional door as an optional extra

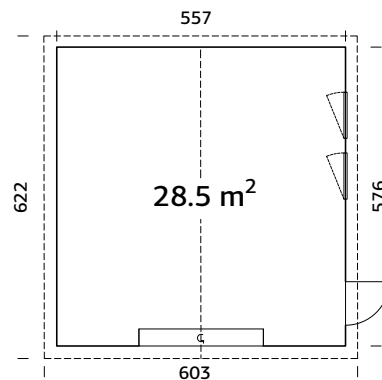

MODEL SPECIFICATIONS

Wall measurements: 557x576 cm

Volume: 78,3 m³

Door/window type: Summer

Door glass:

Double glass, 4-9-4 mm

Window glass:

Double glass, 3-9-3 mm

Window opening

measurements: 69x38 cm

Door opening

measurements: 78x191, 221x188 cm

Door sill: hard wood

Roof boards: 19 mm

Roof area: 39,8 m²

Roof gradient: 20,0°

Gross ground area: 32,1 m²

Door and window elements are interchangeable.

Double glazed.

Trendy look! Fine-sawn cladding.

Ready-made wall elements with wind protection plastic!

Sectional door included.

OPTIONAL

Roofing felt (underlayer): 7 rolls, SBS roofing material: 7 rolls, shingles: 15 packs, roofing nails, rain gutters, additional door and window, canopy roof, engine set for garage sectional door.

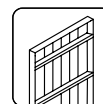

160 mm

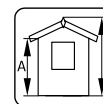

A: 216 cm
B: 337 cm

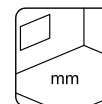

-

PALMAKO NORDIC+ GARAGE ANDRE 44,7 m²

WITH SECTIONAL DOOR



PALMAKO GARAGES
256-273

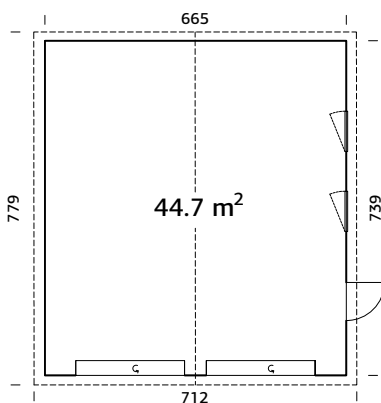

Andre 44,7 m2 kit without door



Engine set for garage sectional door as an optional extra

MODEL SPECIFICATIONS

Wall measurements: 665x739 cm

Volume: 142,0 m³

Door/window type: Summer

Door glass:

Double glass, 4-9-4 mm

Window glass:

Double glass, 3-9-3 mm

Window opening

measurements: 68x37 cm

Door opening

measurements: 78x191, 221x188 cm

Door sill: hard wood

Roof boards: 19 mm

Roof area: 60,0 m²

Roof gradient: 20,0°

Gross ground area: 49,1 m²

Door and window element are interchangeable.
Double glazed.
Trendy look! Fine-sawn cladding.
Ready-made wall elements with wind protection plastic!
Sectional door included.

OPTIONAL

Roofing felt (underlayer): 11 rolls, SBS roofing material: 11 rolls, shingles: 23 packs, roofing nails, rain gutters, additional door and window, canopy roof, engine set for garage sectional door.

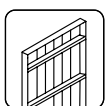

160 mm

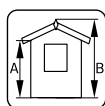

A: 216 cm
B: 357 cm

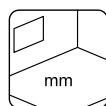

-



Scan this barcode to see the assembly of Andre 44,7 m²!

OPTIONAL PRODUCTS

SEE OPTIONAL PRODUCTS, PAGES 344-368

House	Art. No.	Roofing felt, rolls	SBS roofing material, rolls	Shingles ¹ , packs	Roofing nails, 1 kg	EPDM	Rain gutters	Extension	Canopy roof	Garage wooden door	Garage sectional door	Engine set for garage sectional door
Rasmus 19,0 m ² kit without door	101894	107210, 6 rolls	107214, 6 rolls	10 packs	107930	2 x 111847	106628	102801	103168	103555	103516	
Rasmus 19,0 m ² with wooden gate	102415	107210, 6 rolls	107214, 6 rolls	10 packs	107930	2 x 111847	106628	102801	103168	103555		
Rasmus 19,0 m ² with sectional door	102419	107210, 6 rolls	107214, 6 rolls	10 packs	107930	2 x 111847	106628	102801	103168	103555	103516	
Roger 19,0 m ² kit without door	101899	107210, 6 rolls	107214, 6 rolls	10 packs	2 x 107930		106632	102801	103168	103555	103516	
Roger 19,0 m ² with wooden gate	102347	107210, 6 rolls	107214, 6 rolls	10 packs	2 x 107930		106632	102801	103168	103555	103516	
Roger 19,0 m ² with sectional door	102355	107210, 6 rolls	107214, 6 rolls	10 packs	2 x 107930		106632	102801	103168	103555	103516	108561
Roger 23,9 m ² kit without door	101903	107210, 7 rolls	107214, 7 rolls	12 packs	2 x 107930		106632	102801	103168	103555	103516	
Roger 23,9 m ² with wooden gate	102498	107210, 7 rolls	107214, 7 rolls	12 packs	2 x 107930		106632	102801	103168	103555	103516	
Roger 23,9 m ² with sectional door	102502	107210, 7 rolls	107214, 7 rolls	12 packs	2 x 107930		106632	102801	103168	103587	103516	108561
Roger 27,7 m ² kit without door	101911	107210, 8 rolls	107214, 8 rolls	14 packs	2 x 107930		106632	102801	103168	103587	103516	
Roger 27,7 m ² with wooden gate	102379	107210, 8 rolls	107214, 8 rolls	14 packs	2 x 107930		106632	102801	103168	103587	103516	
Roger 27,7 m ² with sectional door	102383	107210, 8 rolls	107214, 8 rolls	14 packs	2 x 107930		106632	102801	103168	103555	103516	108561
Roger 21,9+5,2 m ² kit without door	101872	107210, 7 rolls	107214, 7 rolls	14 packs	2 x 107930		106632	102801	103168	103555	103516	
Roger 21,9+5,2 m ² with wooden gate	102482	107210, 7 rolls	107214, 7 rolls	14 packs	2 x 107930		106632	102801	103168	103555	103516	
Roger 21,9+5,2 m ² with sectional door	102486	107210, 7 rolls	107214, 7 rolls	14 packs	2 x 107930		106632	102801	103168	103555	103516	108561
Roger 28,4 m ² kit without door	101907	107210, 9 rolls	107214, 9 rolls	14 packs	2 x 107930		106632	102801	103168	103555	103516	
Roger 28,4 m ² with wooden gate	102399	107210, 9 rolls	107214, 9 rolls	14 packs	2 x 107930		106632	102801	103168	103555	103516	
Roger 28,4 m ² with sectional door	102403	107210, 9 rolls	107214, 9 rolls	14 packs	2 x 107930		106632	102801	103168	103555	103516	108561

¹ Shingles are available in different colours - 107180 = Black, 107182 = Red, 107183 = Green, 107181 = Brown. The article number is indicated for untreated items, for treated items ask our sales team.

OPTIONAL PRODUCTS

SEE OPTIONAL PRODUCTS, PAGES 344-368

House	Art. No.	Roofing felt, rolls	SBS roofing material, rolls	Shingles ¹ , packs	Roofing nails, 1 kg	Rain gutters	Garage wooden door	Garage sectional door	Engine set for garage sectional door
Roger 19,0+16,2 m ² kit without door	120074	107210, 8 rolls	107214, 8 rolls	18 packs	2 x 107930	2 x 106630	103555	103516	
Roger 19,0+16,2 m ² with wooden gate	120078	107210, 8 rolls	107214, 8 rolls	18 packs	2 x 107930	2 x 106630	103555		
Roger 19,0+16,2 m ² with sectional door	120082	107210, 8 rolls	107214, 8 rolls	18 packs	2 x 107930	2 x 106630	103516	103516	108561
Roger 19,0+33,2 m ² kit without door	120086	107210, 10 rolls	107214, 10 rolls	24 packs	3 x 107930	106631 + 106632	103555	103516	
Roger 19,0+33,2 m ² with wooden gate	120090	107210, 10 rolls	107214, 10 rolls	24 packs	3 x 107930	106631 + 106632	103555		
Roger 19,0+33,2 m ² with sectional door	120094	107210, 10 rolls	107214, 10 rolls	24 packs	3 x 107930	106631 + 106632		103516	108561
Andre 21,5 m ² kit without door	108613	107210, 7 rolls	107214, 7 rolls	13 packs	2 x 107930	106632		103516	
Andre 21,5 m ² with sectional door	101159	107210, 7 rolls	107214, 7 rolls	13 packs	2 x 107930	106632		103516	108561
Andre 28,5 m ² kit without door	108614	107210, 7 rolls	107214, 7 rolls	15 packs	2 x 107930	106629 + 106630		103516	
Andre 28,5 m ² with sectional door	101167	107210, 7 rolls	107214, 7 rolls	15 packs	2 x 107930	106629 + 106630		103516	108561
Andre 44,7 m ² kit without door	108615	107210, 11 rolls	107214, 11 rolls	23 packs	3 x 107930	2 x 106630		103516	
Andre 44,7 m ² with sectional door	108616	107210, 11 rolls	107214, 11 rolls	23 packs	3 x 107930	2 x 106630		103516	108561

¹ Shingles are available in different colours - 107180 = Black, 107182 = Red, 107183 = Green, 107181 = Brown.



Karl 40,6 m² with shed



CARPORTS

CARPORTS



PALMAKO CARPORT
ROBERT 11,7 m²



PALMAKO CARPORT
ROBERT 23,1 m²



PALMAKO CARPORT
ROBERT 20,6 m²



PALMAKO CARPORT
ROBERT 40,6 m²



PALMAKO CARPORT
ROBERT 23,1 m² WITH SHED



PALMAKO CARPORT
ROBERT 40,6 m² WITH SHED



PALMAKO CARPORT
KARL 11,7 m²



PALMAKO CARPORT
KARL 23,1 m²



PALMAKO CARPORT
KARL 20,6 m²



PALMAKO CARPORT
KARL 40,6 m²



PALMAKO CARPORT
KARL 23,1 m² WITH SHED



PALMAKO CARPORT
KARL 40,6 m² WITH SHED

PALMAKO CARPORT ROBERT 11,7 m²

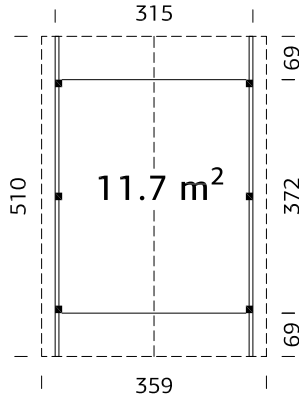

Strong posts from laminated wood.

TREATMENT

- Available dipped
Available painted

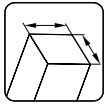

120x120 mm

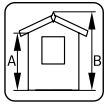

A: 199 cm
B: 299 cm

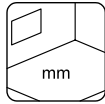

MODEL SPECIFICATIONS

Measurements:
315x372 cm

Volume: 30,8 m³

Roof boards: 19 mm

Roof area: 20,1 m²

Roof gradient: 25,0°

Gross ground area: 11,7 m²

OPTIONAL

Roofing felt (underlayer): 5 rolls, SBS roofing material: 5 rolls, shingles: 8 packs, roofing nails, rain gutters, anchors.

PALMAKO CARPORT ROBERT 20,6 m²

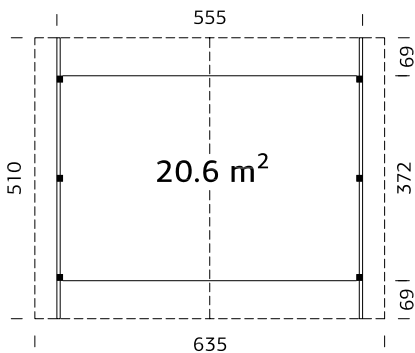

Strong posts and purlins from laminated wood.

TREATMENT

- Available dipped
Available painted

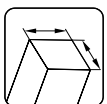

120x120 mm

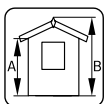

A: 199 cm
B: 363 cm

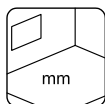

MODEL SPECIFICATIONS

Measurements:
555x372 cm

Volume: 61,5 m³

Roof boards: 19 mm

Roof area: 35,8 m²

Roof gradient: 25,0°

Gross ground area: 20,6 m²

OPTIONAL

Roofing felt (underlayer): 9 rolls, SBS roofing material: 9 rolls, shingles: 14 packs, roofing nails, rain gutters, anchors.

PALMAKO CARPORT ROBERT 23,1 m²



NEW!

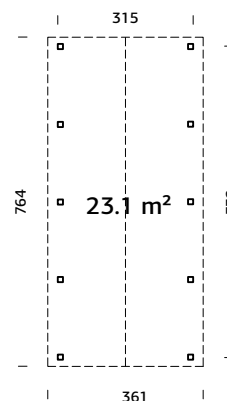

Strong posts from laminated wood.

TREATMENT

- Available dipped
- Available painted

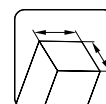

120x120 mm

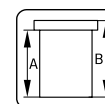

A: 210 cm
B: 299 cm

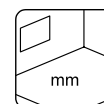

-

MODEL SPECIFICATIONS

Measurements: 315x732 cm
Volume: 57,1 m³
Roof boards: 19 mm

Roof area: 29,8 m²
Roof gradient: 25,0°
Gross ground area: 23,1 m²

OPTIONAL

Roofing felt (underlayer): 5 rolls, SBS roofing material: 5 rolls, shingles: 12 packs, roofing nails, rain gutters, anchors.

PALMAKO CARPORT ROBERT 23,1 m² WITH SHED

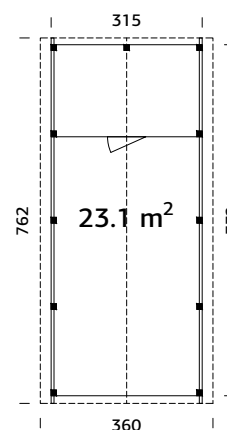

NEW!



Strong posts from laminated wood.

TREATMENT

- Available dipped
- Available painted

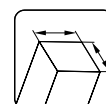

120x120 mm

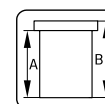

A: 210 cm
B: 299 cm

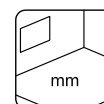

-

MODEL SPECIFICATIONS

Measurements: 315x732 cm
Volume: 57,1 m³
Roof boards: 19 mm

Roof area: 29,8 m²
Roof gradient: 25,0°
Gross ground area: 23,1 m²

OPTIONAL

Roofing felt (underlayer): 5 rolls, SBS roofing material: 5 rolls, shingles: 12 packs, roofing nails, rain gutters, anchors.

PALMAKO CARPORT ROBERT 40,6 m²

NEW!

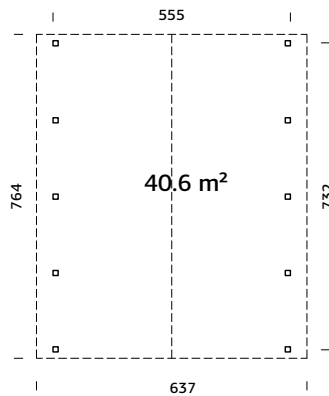

Strong posts from laminated wood.

TREATMENT

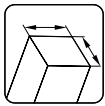
Available dipped Available painted 

120x120 mm

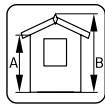
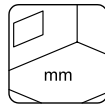
A: 210 cm
B: 363 cm

-

MODEL SPECIFICATIONS

Measurements:

555x732 cm

Volume: 120,0 m³

Roof boards: 19 mm

Roof area: 53,2 m²

Roof gradient: 25,0°

Gross ground area: 40,6 m²

OPTIONAL

Roofing felt (underlayer): 8 rolls, SBS roofing material: 8 rolls, shingles: 20 packs, roofing nails, rain gutters, anchors.

PALMAKO
CARPORTS

274-283

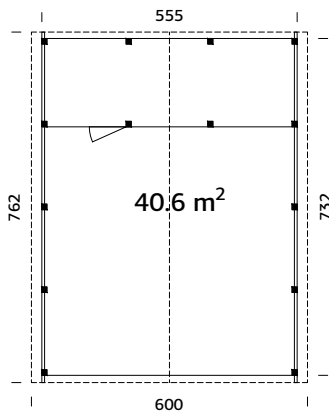
PALMAKO CARPORT ROBERT 40,6 m² WITH SHED

Strong posts and purlins from laminated wood.



NEW!

TREATMENT

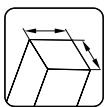
Available dipped Available painted 

120x120 mm

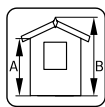
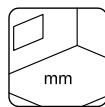
A: 210 cm
B: 363 cm

-

MODEL SPECIFICATIONS

Measurements:

555x732 cm

Volume: 120,0 m³

Roof boards: 19 mm

Roof area: 53,2 m²

Roof gradient: 25,0°

Gross ground area: 40,6 m²

OPTIONAL

Roofing felt (underlayer): 8 rolls, SBS roofing material: 8 rolls, shingles: 20 packs, roofing nails, rain gutters, anchors.

PALMAKO CARPORT KARL 11,7 m²



under 2,5m

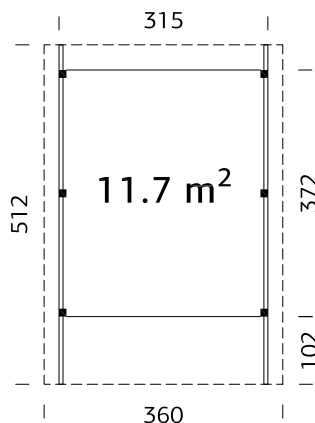

Strong posts from laminated wood.



Arch from laminated wood

MODEL SPECIFICATIONS

Measurements: 315x372 cm
Volume: 39,6 m³
Roof boards: 19 mm

Roof area: 18,0 m²
Roof gradient: 1,1°
Gross ground area: 11,7 m²

OPTIONAL

Roofing felt (underlayer): 6 rolls, SBS roofing material: 6 rolls, roofing nails, EPDM, rain gutters, anchors, arch from laminated wood.

TREATMENT

- Available dipped
- Available painted

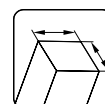

120x120 mm

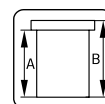

A: 215 cm
B: 232 cm

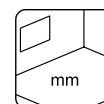

-

PALMAKO CARPORTS

274-283

PALMAKO CARPORT KARL 20,6 m²



under 2,5m

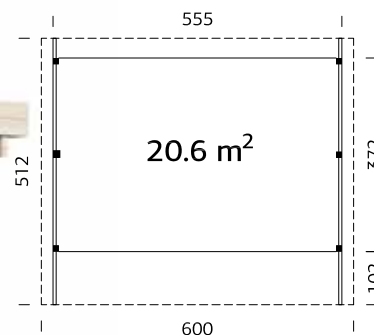

Strong posts from laminated wood.



Arch from laminated wood

MODEL SPECIFICATIONS

Measurements: 555x372 cm
Volume: 67,8 m³
Roof boards: 19 mm

Roof area: 30,7 m²
Roof gradient: 1,1°
Gross ground area: 20,6 m²

OPTIONAL

Roofing felt (underlayer): 7 rolls, SBS roofing material: 7 rolls, roofing nails, EPDM, rain gutters, anchors, arch from laminated wood.

TREATMENT

- Available dipped
- Available painted

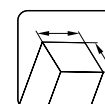

120x120 mm

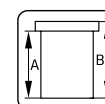

A: 221 cm
B: 244 cm

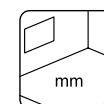

-

PALMAKO CARPORT KARL 23,1 m²



under 2,5m

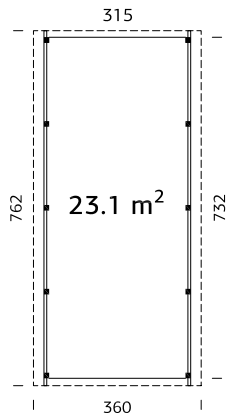

Strong posts from laminated wood.

TREATMENT

- Available dipped
- Available painted



Arch from laminated wood

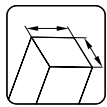

120x120 mm

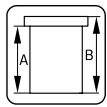

A: 215 cm
B: 232 cm

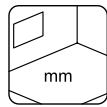

-

MODEL SPECIFICATIONS

Measurements:

315x732 cm

Volume: 60,0 m³

Roof boards: 19 mm

Roof area: 27,4 m²

Roof gradient: 1,1°

Gross ground area: 23,1 m²

OPTIONAL

Roofing felt (underlayer): 6 rolls, SBS roofing material: 6 rolls, roofing nails, EPDM, rain gutters, anchors, arch from laminated wood.

PALMAKO
CARPORTS

274-283

PALMAKO CARPORT KARL 23,1 m² WITH SHED

NEW!

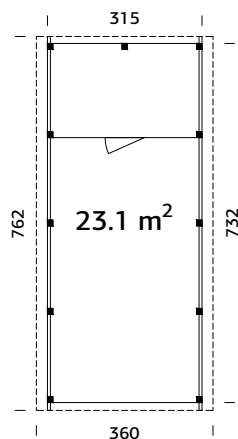

Strong posts from laminated wood.

TREATMENT

- Available dipped
- Available painted



Arch from laminated wood

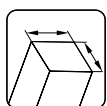

120x120 mm

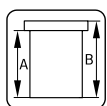

A: 215 cm
B: 232 cm

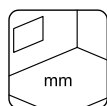

-

MODEL SPECIFICATIONS

Measurements:

315x732 cm

Volume: 60,0 m³

Roof boards: 19 mm

Roof area: 27,4 m²

Roof gradient: 1,1°

Gross ground area: 23,1 m²

OPTIONAL

Roofing felt (underlayer): 6 rolls, SBS roofing material: 6 rolls, roofing nails, EPDM, rain gutters, anchors, arch from laminated wood.

PALMAKO CARPORT KARL 40,6 m²



under 2,5m



Arch from laminated wood



Scan this barcode to see the assembly of Karl 40,6 m²!

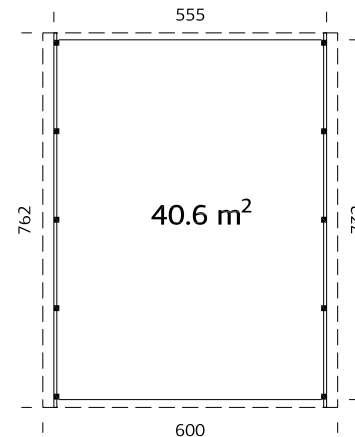

Strong posts from laminated wood.

MODEL SPECIFICATIONS

Measurements:
555x732 cm
Volume: 103,0 m³
Roof boards: 19 mm

Roof area: 46,6 m²
Roof gradient: 1,1°
Gross ground area: 45,7 m²

OPTIONAL

Roofing felt (underlayer): 8 rolls, SBS roofing material: 8 rolls, roofing nails, EPDM, rain gutters, anchors, arch from laminated wood.

TREATMENT

Available dipped
Available painted

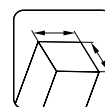

120x120 mm

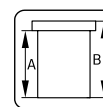

A: 221 cm
B: 244 cm

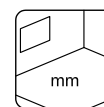

mm

PALMAKO CARPORTS

274-283

PALMAKO CARPORT KARL 40,6 m² WITH SHED



under 2,5m

NEW!



Arch from laminated wood

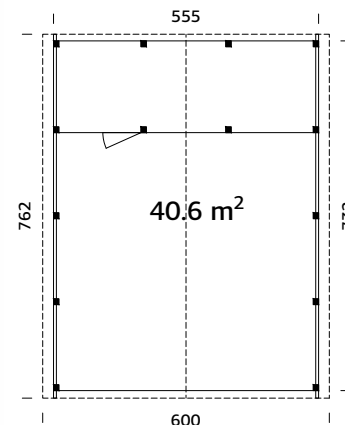

Strong posts from laminated wood.

MODEL SPECIFICATIONS

Measurements:
555x732 cm
Volume: 103,0 m³
Roof boards: 19 mm

Roof area: 46,6 m²
Roof gradient: 1,1°
Gross ground area: 45,7 m²

OPTIONAL

Roofing felt (underlayer): 8 rolls, SBS roofing material: 8 rolls, roofing nails, EPDM, rain gutters, anchors, arch from laminated wood.

TREATMENT

Available dipped
Available painted

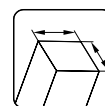

120x120 mm

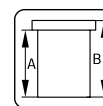

A: 221 cm
B: 244 cm

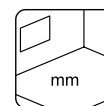

mm

OPTIONAL PRODUCTS

SEE OPTIONAL PRODUCTS, PAGES 344-368

House	Art. No.	Roofing felt, rolls	SBS roofing material, rolls	Shingles ¹ , packs	Roofing nails, 1 kg	EPDM	Rain gutters	Anchor, adjustable post leg	Carport arch, laminated wood
Robert 11,7 m ²	101013	107210 5 rolls	107214 5 rolls	8 packs	107930		106632	106608	
Robert 23,1 m ²	119273	107210 5 rolls	107214 5 rolls	12 packs	2 x 107930		2 x 106630	106608	
Robert 20,6 m ²	101029	107210 9 rolls	107214 5 rolls	14 packs	2 x 107930		106632	106608	
Robert 40,6 m ²	119333	107210 8 rolls	107214 8 rolls	20 packs	3 x 107930		2 x 106630	106608	
Robert 23,1 m ² with shed	120112	107210 5 rolls	107214 5 rolls	12 packs	2 x 107930		2 x 106630	106608	
Robert 40,6 m ² with shed	120117	107210 8 rolls	107214 8 rolls	20 packs	3 x 107930		2 x 106630	106608	
Karl 11,7 m ²	101021	107210 6 rolls	107214 6 rolls		107930	2 x 111847	106627	106608	102765
Karl 23,1 m ²	101025	107210 6 rolls	107214 6 rolls		107930	3 x 111847	106627	106608	102765
Karl 20,6 m ²	101033	107210 7 rolls	107214 7 rolls		2 x 107930	3 x 111847	106628	106608	102765
Karl 40,6 m ²	101037	107210 8 rolls	107214 8 rolls		2 x 107930	4 x 111847	106628	106608	102765
Karl 23,1 m ² with shed	120107	107210 6 rolls	107214 6 rolls		107930	3 x 111847	106627	106608	102765
Karl 40,6 m ² with shed	120122	107210 8 rolls	107214 8 rolls		107930	4 x 111847	106628	106608	102765

¹ Shingles are available in different colours - 107180 = Black, 107182 = Red, 107183 = Green, 107181 = Brown. The article number is indicated to untreated items, for treated items ask our sales team.



Kalle 16,9 m²



SHEDS

SHEDS



PALMAKO CHICKEN COOP
CHICK 6,7 m²



PALMAKO SHED
MIA 3,6 m²



PALMAKO SHED
MIA 5,4 m²



PALMAKO SHED
LEIF 2,2 m²



PALMAKO SHED
LEIF 3,0 m²



PALMAKO SHED
LEIF 4,5 m²



PALMAKO SHED
LEIF 3,0+2,9 m²



PALMAKO SHED
LEIF 4,5+2,9 m²



PALMAKO SHED
DAN 4,5 m²



PALMAKO SHED
DAN 7,5 m²



PALMAKO SHED
DAN 9,9 m²



PALMAKO SHED
DAN 14,7 m²



PALMAKO SHED
NILS 5,4 m²



PALMAKO SHED
NILS 8,2 m²



PALMAKO SHED
LUCAS 5,4 m²



PALMAKO SHED
LUCAS 12,1 m²



PALMAKO SHED
MARCUS 6,5 m²



PALMAKO SHED
STIG 8,2 m²



PALMAKO SHED
JARI 8,9 m²



PALMAKO SHED
JARI 14,5 m²



PALMAKO SHED
MARTIN 8,4 m²



PALMAKO SHED
MARTIN 13,6 m²



PALMAKO SHED
OLAF 6,6 m²



PALMAKO SHED
OLAF 13,5 m²



PALMAKO SHED
OLAF 16,9 m²



PALMAKO SHED
KALLE 6,6 m²



PALMAKO SHED
KALLE 13,5 m²



PALMAKO SHED
KALLE 16,9 m²



PALMAKO KIOSK
KIRA 7,7 m²



PALMAKO KIOSK
STELLA 5,0 m²



PALMAKO KIOSK
STELLA 8,2 m²



NEW

PALMAKO FOLDING KIOSK
MARIAN 6,2 m²

PALMAKO CHICKEN COOP CHICK 6,7 m²

**NEW!
METAL ROOF!**

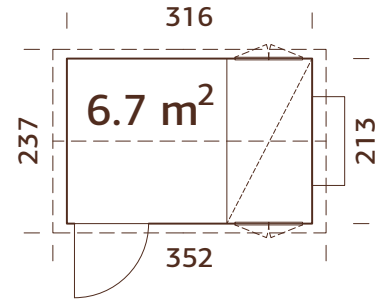

Metal roof included.

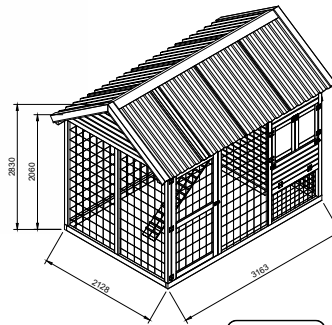

MODEL SPECIFICATIONS

Wall measurements:

213x316 cm

Volume: 17,0 m³

Window glass:

Acrylglass

Window opening

measurements: 96x59 cm

Door opening

measurements: 95x187 cm

Roof area: 10,0 m²

Roof gradient: 34,0°

Gross ground area: 6,7 m²

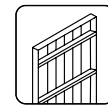

16+32 mm

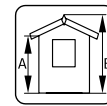

A: 206 cm

B: 283 cm

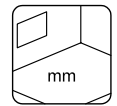

mm

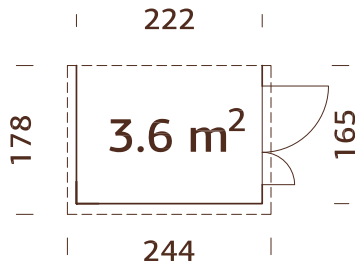

Chick 6,7 m²

PALMAKO SHED MIA 3,6 m²under
2,5m

Door can be placed on opposite side.
Ready-made wall elements.
One side wall is not included in the product set.

TREATMENT

Available dipped
Available painted



16+32 mm

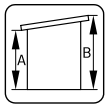

A: 173 cm
B: 210 cm

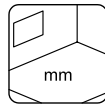

Included
16 mm

MODEL SPECIFICATIONS**Wall measurements:**

222x165 cm

Volume: 6,4 m³**Door opening****measurements:** 103x166 cm**Roof boards:** 16 mm**Roof area:** 4,4 m²**Roof gradient:** 12,0°**Gross ground area:** 3,7 m²**OPTIONAL**

Roofing felt (underlayer): 1 roll, SBS roofing material: 1 roll, roofing nails, EPDM.

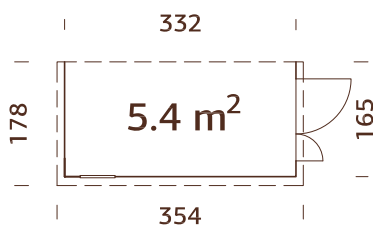
PALMAKO SHED MIA 5,4 m²under
2,5m

Door can be placed on opposite side.
Ready-made wall elements.
One side wall is not included in the product set.

TREATMENT

Available dipped
Available painted

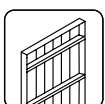

16+32 mm

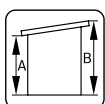

A: 173 cm
B: 210 cm

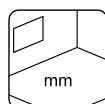

Included
16 mm

MODEL SPECIFICATIONS**Wall measurements:**

333x165 cm

Volume: 9,6 m³**Door/window glass:**

Acrylglas

Fixed window,**measurements:** 41x46 cm**Door opening****measurements:** 103x166 cm**Roof boards:** 16 mm**Roof area:** 6,3 m²**Roof gradient:** 12,0°**Gross ground area:** 5,5 m²**OPTIONAL**

Roofing felt (underlayer): 1 roll, SBS roofing material: 1 roll, roofing nails, EPDM.

PALMAKO SHED LEIF 2,2 m²

under 2,5m



MODEL SPECIFICATIONS

- Wall measurements:** 234x95 cm
- Volume:** 3,7 m³
- Door opening measurements:** 104x160 cm
- Roof boards:** 16 mm
- Roof area:** 2,8 m²
- Roof gradient:** 10,0°
- Gross ground area:** 2,3 m²

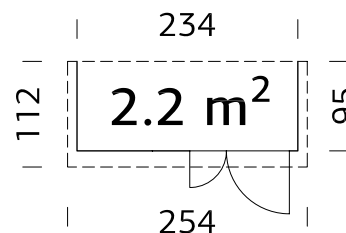

Ready-made wall elements.
Back wall is not included in the product set.

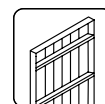

16+32 mm

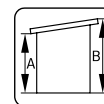

A: 173 cm
B: 189 cm

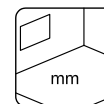

Included 16 mm

TREATMENT

- Available dipped
- Available painted

OPTIONAL

Roofing felt (underlayer): 1 roll, SBS roofing material: 1 roll, roofing nails, EPDM.

PALMAKO SHED LEIF 3,0 m²

under 2,5m



MODEL SPECIFICATIONS

- Wall measurements:** 183x170 cm
- Volume:** 6,2 m³
- Door opening measurements:** 102x182 cm
- Roof boards:** 16 mm
- Roof area:** 3,5 m²
- Roof gradient:** 12,0°
- Gross ground area:** 3,1 m²

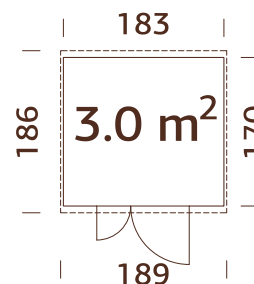

Ready-made wall elements.

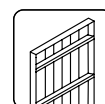

16+32 mm

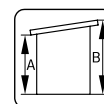

A: 190 cm
B: 230 cm

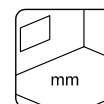

Included 16 mm

TREATMENT

- Available dipped
- Available painted

OPTIONAL

Roofing felt (underlayer): 1 roll, SBS roofing material: 1 roll, roofing nails, EPDM.

PALMAKO SHED LEIF 4,5 m²

under 2,5m



MODEL SPECIFICATIONS

- Wall measurements:** 273x170 cm
- Volume:** 8,8 m³
- Door opening measurements:** 102x182 cm
- Roof boards:** 16 mm
- Roof area:** 5,2 m²
- Roof gradient:** 12,0°
- Gross ground area:** 4,6 m²

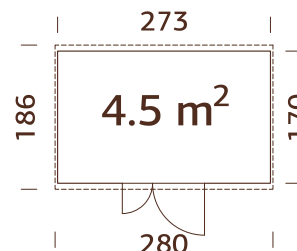

Ready-made wall elements.

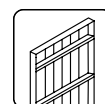

16+32 mm

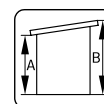

A: 190 cm
B: 230 cm

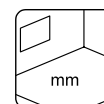

Included 16 mm

TREATMENT

- Available dipped
- Available painted

OPTIONAL

Roofing felt (underlayer): 1 roll, SBS roofing material: 1 roll, roofing nails, EPDM.

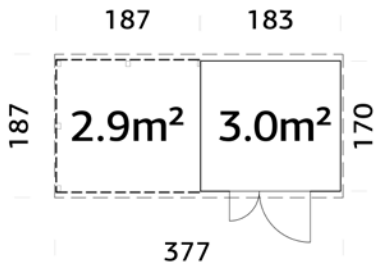
PALMAKO SHED LEIF 3,0+2,9 m²under
2,5m

Ready made wall elements.

TREATMENT

- Available dipped
Available painted

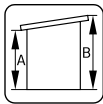
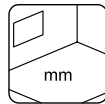

16+32 mm

A: 188 cm
B: 228 cmIncluded
16 mm

MODEL SPECIFICATIONS

Wall measurements:

370x170 cm

Volume: 6,2+6,2 m³

Door opening

measurements: 102x182 cm

Roof boards: 16 mm

Roof area: 7,0 m²

Roof gradient: 12,0°

Gross ground area: 6,3 m²

OPTIONAL

Roofing felt (underlayer): 2 rolls, SBS roofing material: 2 rolls, roofing nails, EPDM.

Can be built in reverse!

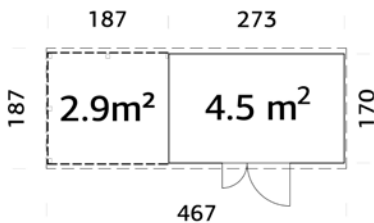
PALMAKO SHED LEIF 4,5+2,9 m²under
2,5m

Ready made wall elements.

TREATMENT

- Available dipped
Available painted

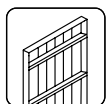

16+32 mm

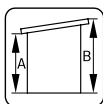
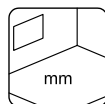
A: 188 cm
B: 228 cmIncluded
16 mm

MODEL SPECIFICATIONS

Wall measurements:

460x170 cm

Volume: 8,8+6,2 m³

Door opening

measurements: 102x182 cm

Roof boards: 16 mm

Roof area: 8,7 m²

Roof gradient: 12,0°

Gross ground area: 7,8 m²

OPTIONAL

Roofing felt (underlayer): 2 rolls, SBS roofing material: 2 rolls, roofing nails, EPDM.

Can be built in reverse!

PALMAKO SHED DAN 4,5 m²

under 2,5m

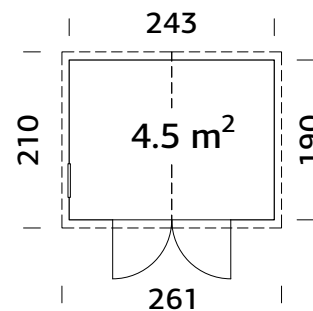

Ready-made wall elements.

MODEL SPECIFICATIONS

Wall measurements:

243x190 cm

Volume: 9,3 m³

Door/window glass:

Acrylglas

Fixed window, measurements:

44x44 cm

Door opening measurements:

138x182 cm

Roof boards: 16 mm

Roof area: 5,5 m²

Roof gradient: 16,0°

Gross ground area: 4,6 m²

TREATMENT

Available dipped

Available painted

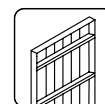

16+32 mm

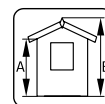

A: 190 cm
B: 220 cm

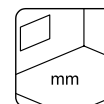

Included 16 mm

OPTIONAL

Roofing felt (underlayer): 1 roll, SBS roofing material: 1 roll, shingles: 3 packs, roofing nails.

PALMAKO SHED DAN 7,5 m²

under 2,5m

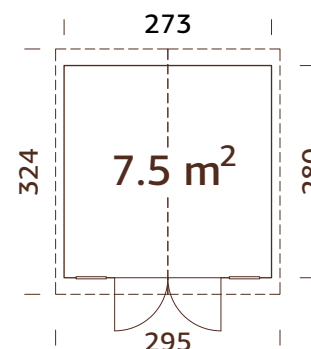

Ready-made wall elements.

MODEL SPECIFICATIONS

Wall measurements:

273x280 cm

Volume: 15,5 m³

Door/window glass:

Acrylglas

Fixed window, measurements:

44x44 cm

Door opening measurements:

138x182 cm

Roof boards: 16 mm

Roof area: 9,8 m²

Roof gradient: 14,0°

Gross ground area: 7,6 m²

TREATMENT

Available dipped

Available painted

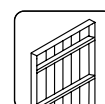

16+32 mm

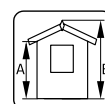

A: 190 cm
B: 220 cm

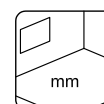

Included 16 mm

OPTIONAL

Roofing felt (underlayer): 2 rolls, SBS roofing material: 2 rolls, shingles: 4 packs, roofing nails.

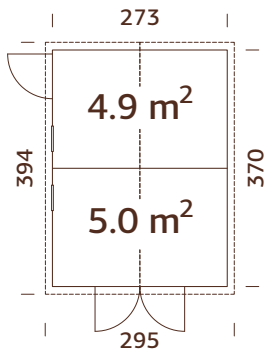
PALMAKO SHED DAN 9,9 m²under
2,5m

Ready-made wall elements.

TREATMENT

- Available dipped
Available painted

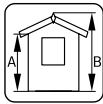
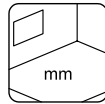

16+32 mm

A: 190 cm
B: 220 cmIncluded
16 mm**MODEL SPECIFICATIONS****Wall measurements:**

273x370 cm

Volume: 19,4 m³**Door/window glass:**

Acrylglas

Fixed window, measurements:

44x44 cm

Door opening measurements:

75x169 cm, 138x182 cm

Roof boards: 16 mm**Roof area:** 12,0 m²**Roof gradient:** 15,0°**Gross ground area:** 10,1 m²**OPTIONAL**

Roofing felt (underlayer): 2 rolls, SBS roofing material: 2 rolls, shingles: 5 packs, roofing nails.

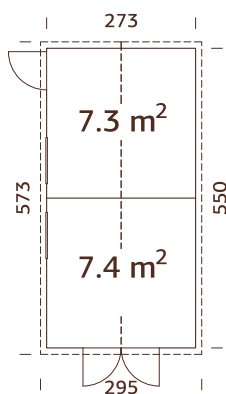
PALMAKO SHED DAN 14,7 m²under
2,5m

Ready-made wall elements.

TREATMENT

- Available dipped
Available painted

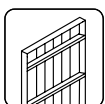

16+32 mm

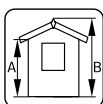
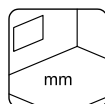
A: 190 cm
B: 230 cmIncluded
16 mm**MODEL SPECIFICATIONS****Wall measurements:**

273x550 cm

Volume: 29,3 m³**Door/window glass:**

Acrylglas

Fixed window, measurements:

44x44 cm

Door opening measurements:

75x169 cm, 138x182 cm

75x169 cm, 138x182 cm

Roof boards: 16 mm**Roof area:** 17,3 m²**Roof gradient:** 15,5°**Gross ground area:** 15,0 m²**OPTIONAL**

Roofing felt (underlayer): 3 rolls, SBS roofing material: 3 rolls, shingles: 7 packs, roofing nails.

PALMAKO SHED NILS 5,4 m²

under
2,5m

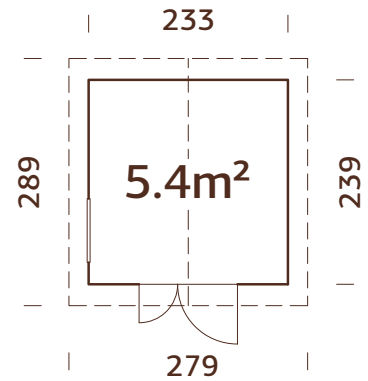

Ready-made wall elements.

MODEL SPECIFICATIONS

Wall measurements:

233x239 cm

Volume: 11,5 m³

Window type: Shed

Window glass: Acrylglass

Fixed window

measurements:

70x46 cm

Door opening

measurements:

112x183 cm

Roof boards: 16 mm

Roof area: 8,4 m²

Roof gradient: 21,0°

Gross ground area: 5,6 m²

TREATMENT

Available dipped

Available painted

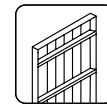

16+32 mm

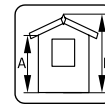

A: 188 cm
B: 238 cm

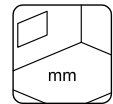

Included
16 mm

OPTIONAL

Roofing felt (underlayer): 2 rolls, SBS roofing material: 2 rolls, shingles: 4 packs, roofing nails, rain gutters.

PALMAKO SHED NILS 8,2 m²

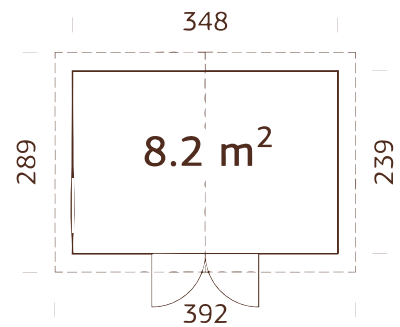

Ready-made wall elements.

MODEL SPECIFICATIONS

Wall measurements:

348x239 cm

Volume: 18,0 m³

Window type: Shed

Window glass:

Acrylglass

OPTIONAL

Roofing felt (underlayer): 2 rolls, SBS roofing material: 2 rolls, shingles: 5 packs, roofing nails, rain gutters.

Fixed window

measurements:

70x46 cm

Door opening

measurements:

135x182 cm

135x182 cm

Roof boards: 16 mm

Roof area: 11,9 m²

Roof gradient: 21,0°

Gross ground area: 8,3 m²

TREATMENT

Available dipped

Available painted

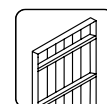

16+32 mm

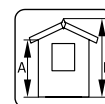

A: 188 cm
B: 259 cm

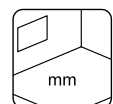

Included
16 mm

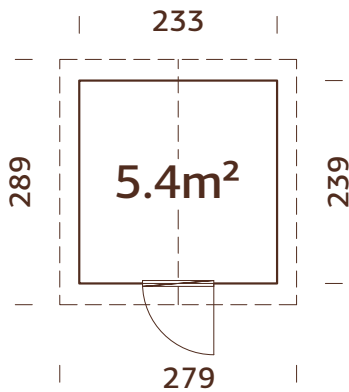
under
2,5mPALMAKO SHED LUCAS 5,4 m²

Ready-made wall elements.



MODEL SPECIFICATIONS

Wall measurements:

233x239 cm

Volume: 11,5 m³

Door type: Summer

Door/window glass:

Real glass, 4 mm

Door opening

measurements: 78x181 cm

Roof boards: 16 mm

Roof area: 11,9 m²

Roof gradient: 21,0°

Gross ground area: 5,6 m²

TREATMENT

Available painted 

16+32 mm

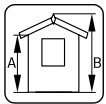
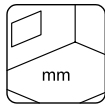
A: 188 cm
B: 238 cmIncluded
16 mm

OPTIONAL

Roofing felt (underlayer): 2 rolls, SBS roofing material: 2 rolls, shingles: 5 packs, roofing nails, rain gutters, additional door.

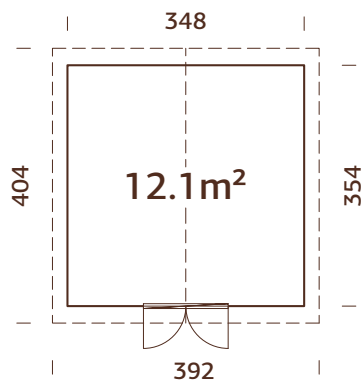
PALMAKO SHED LUCAS 12,1 m²

Ready-made wall elements.



MODEL SPECIFICATIONS

Wall measurements:

348x354 cm

Volume: 26,7 m³

Door type: Summer

Door/window glass:

Real glass, 4 mm

Door opening

measurements: 117x191 cm

Roof boards: 16 mm

Roof area: 16,7 m²

Roof gradient: 21,0°

Gross ground area: 12,3 m²

TREATMENT

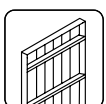
Available painted 

16+32 mm

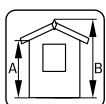
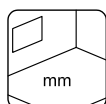
A: 188 cm
B: 259 cmIncluded
16 mm

OPTIONAL

Roofing felt (underlayer): 3 rolls, SBS roofing material: 3 rolls, shingles: 7 packs, roofing nails, rain gutters, additional door.

PALMAKO SHED MARCUS 6,5 m²

under 2,5m

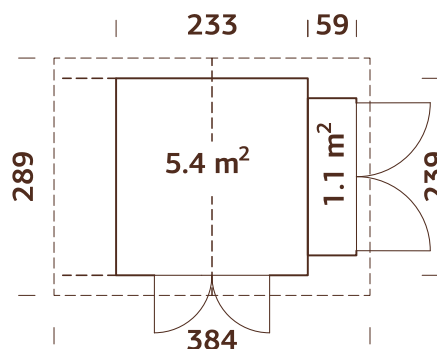

Ready-made wall elements.

MODEL SPECIFICATIONS

Wall measurements:

233x239 cm

Volume: 13,5 m³

Door/window glass:

Acrylglass

Door opening

measurements:

135x183, 181x152 cm

Roof boards: 16 mm

Roof area: 11,2 m²

Roof gradient: 21,0°

Gross ground area: 7,0 m²

TREATMENT

Available dipped

Available painted

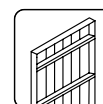

16+32 mm

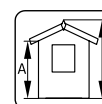

A: 188 cm
B: 240 cm

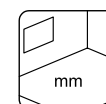

Included
16 mm

OPTIONAL

Roofing felt (underlayer): 2 rolls, SBS roofing material: 2 rolls, shingles: 5 packs, roofing nails.

PALMAKO SHED STIG 8,2 m²

under 2,5m

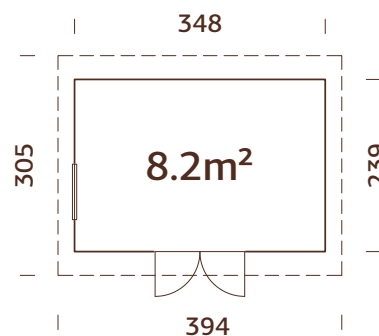

Ready-made wall elements.

MODEL SPECIFICATIONS

Wall measurements:

348x239 cm

Volume: 18,8 m³

Door type: Summer

Door/window glass:

Acrylglass

Fixed window

measurements: 71x54 cm

Door opening

measurements: 138x181 cm

Roof boards: 16 mm

Roof area: 11,6 m²

Roof gradient: 5,0°

Gross ground area: 8,4 m²

TREATMENT

Available painted

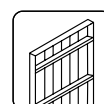

16+32 mm

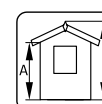

A: 205 cm
B: 250 cm

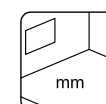

Included
16 mm

OPTIONAL

Roofing felt (underlayer): 2 rolls, SBS roofing material: 2 rolls, roofing nails, EPDM, rain gutters, additional door.

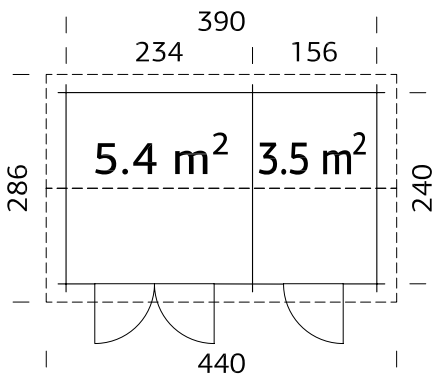
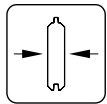
PALMAKO SHED JARI 8,9 m²under
2,5m**TREATMENT**Available dipped 

28 mm

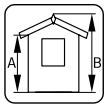
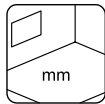
A: 211 cm
B: 249 cmIncluded
19 mm**MODEL SPECIFICATIONS****Log measurements:**

410x260 cm

Volume: 20,8 m³**Door opening****measurements:**

156x180 cm, 78x180 cm

Roof boards: 19 mm**Roof area:** 13,1 m²**Roof gradient:** 15,2°**Gross ground area:** 9,4 m²**OPTIONAL**

Roofing felt (underlayer): 2 rolls, SBS roofing material: 2 rolls, shingles: 6 packs, roofing nails, rain gutters.

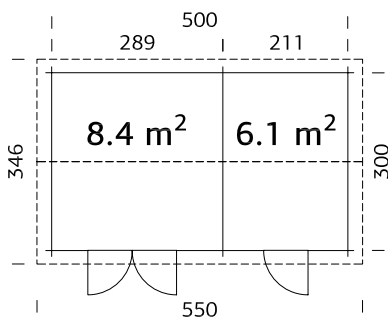
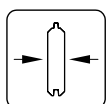
PALMAKO SHED JARI 14,5 m²under
2,5m**TREATMENT**Available dipped 

28 mm

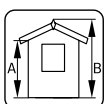
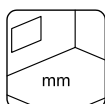
A: 211 cm
B: 249 cmIncluded
19 mm**MODEL SPECIFICATIONS****Log measurements:**

520x320 cm

Volume: 33,7 m³**Door opening****measurements:**

156x180 cm, 78x180 cm

Roof boards: 19 mm**Roof area:** 19,6 m²**Roof gradient:** 14,9°**Gross ground area:** 15,0 m²**OPTIONAL**

Roofing felt (underlayer): 5 rolls, SBS roofing material: 5 rolls, shingles: 8 packs, roofing nails, rain gutters.

THE DOOR QUALITY OF MARTIN, OLAF AND KALLE SHEDS

Contemporary-style buildings including Martin, Olaf and Kalle sheds have ready-made wall elements that are covered inside with wind and moisture protection plastic, making these houses extremely weatherproof. A model contains a set of wall and window-door elements which can be rearranged in several ways. Simple construction allows for fast and easy assembly.

These models also have 32 mm EPS (expanded polystyrene) insulated doors, which make them especially rain and wind resistant. Please study the drawing.

1. HDF 3mm
2. EPS 50 32mm insulation
3. Wooden cladding 12x114mm
4. Wooden skeleton 32x40mm
5. Wooden laminated frame 44x90mm
6. Hardwood 28x78mm threshold
7. Metal kick plate 0,5mm covered with black pural matt coating
8. Hinge 115x84x3mm (3x)
9. 2018 lock and lock box

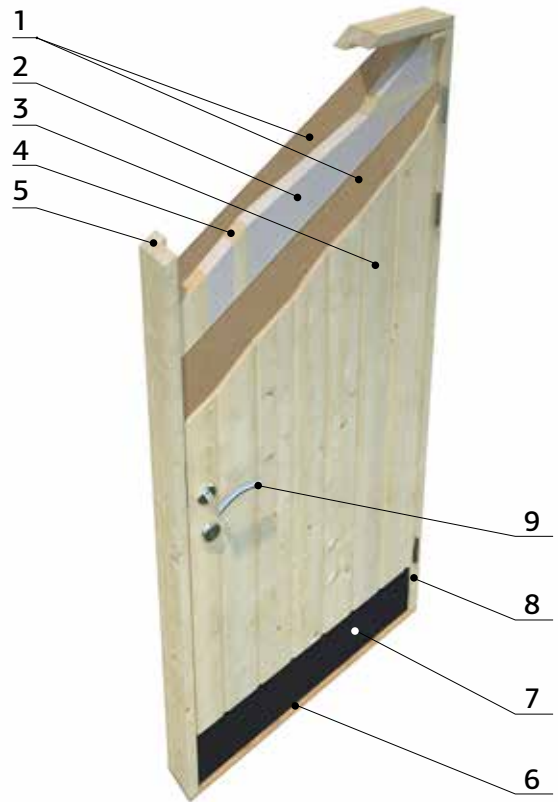

PALMAKO SHED MARTIN 8,4 m²

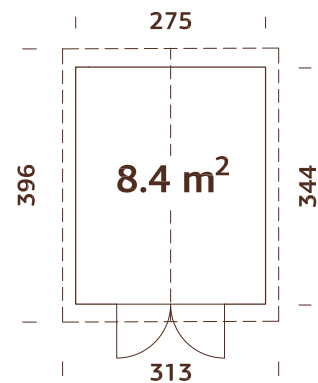

MODEL SPECIFICATIONS

Wall measurements:

275x344 cm

Volume: 21,0 m³

Door type:

Summer

Door opening measurements:

138x181 cm

Door sill: hard wood

Roof boards: 19 mm

Roof area: 13,0 m²

Roof gradient: 20,0°

Gross ground area: 9,5 m²

Ready-made wall elements with wind protection plastic!
Trendy look! Fine-sawn cladding.

OPTIONAL

Roofing felt (underlayer): 2 rolls, SBS roofing material: 2 rolls, shingles: 6 packs, roofing nails, rain gutters, additional door.

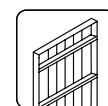

18+70 mm

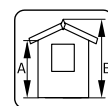

A: 209 cm
B: 267 cm

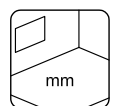

Included
19 mm

PALMAKO SHED MARTIN 13,6 m²

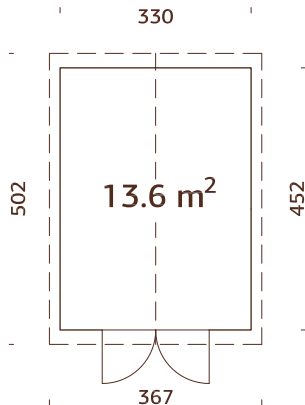

Ready-made wall elements
with wind protection plastic!
Trendy look! Fine-sawn cladding.

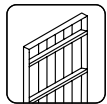

18+70 mm

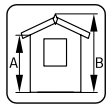

A: 203 cm
B: 296 cm

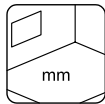

Included
19 mm

MODEL SPECIFICATIONS

Wall measurements:

330x452 cm

Volume: 35,2 m³

Door type: Summer

Door opening

measurements:

138x181 cm

Door sill: hard wood

Roof boards: 19 mm

Roof area: 19,5 m²

Roof gradient: 20,0°

Gross ground area: 14,9 m²

OPTIONAL

Roofing felt (underlayer): 5 rolls, SBS roofing material: 5 rolls, shingles: 8 packs, roofing nails, rain gutters, additional door. See Optional Products p.324-345 for details.

PALMAKO SHED OLAF 6,6 m²

under
2,5m

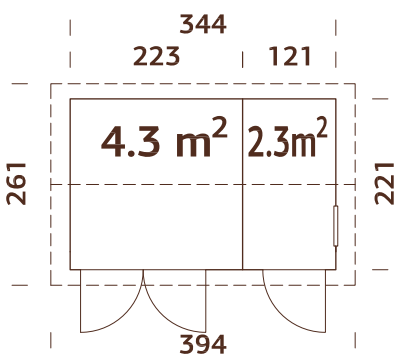

Ready-made wall elements with
wind protection plastic!
Trendy look! Fine-sawn cladding.

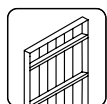

18+70 mm

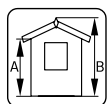

A: 209 cm
B: 247 cm

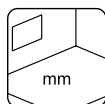

Included
19 mm

MODEL SPECIFICATIONS

Wall measurements:

344x221 cm

Volume: 14,8 m³

Door/window type: Summer

Window glass:

Double toughened, 4-9-4 mm

Fixed window,

measurements: 50x54 cm

Door opening

measurements:

78x181 cm, 138x181 cm

Door sill: hard wood

Roof boards: 19 mm

Roof area: 10,3 m²

Roof gradient: 15,0°

Gross ground area: 7,6 m²

OPTIONAL

Roofing felt (underlayer): 2 rolls, SBS roofing material: 2 rolls, shingles: 5 packs, roofing nails, rain gutters, additional door and window.

PALMAKO SHED OLAF 13,5 m²

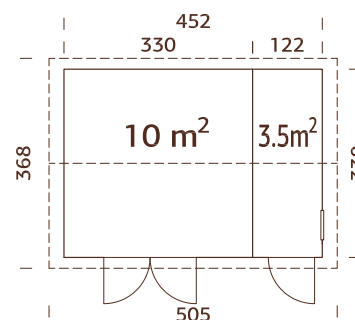

Ready-made wall elements with wind protection plastic!
Trendy look! Fine-sawn cladding.

MODEL SPECIFICATIONS

Wall measurements:

452x330 cm

Volume: 33,8 m³

Door/window type: Summer

Window glass:

Double toughened, 4-9-4 mm

Fixed window, measurements:

50x54 cm

Door opening

measurements:

78x181 cm, 138x181 cm

Door sill: hard wood

Roof boards: 19 mm

Roof area: 18,8 m²

Roof gradient: 15,0°

Gross ground area: 14,9 m²

OPTIONAL

Roofing felt (underlayer): 3 rolls, SBS roofing material: 3 rolls, shingles: 8 packs, roofing nails, rain gutters, additional door and window.

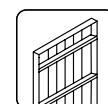

18+70 mm

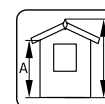

A: 209 cm

B: 261 cm

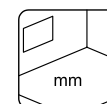

Included

19 mm

PALMAKO SHED OLAF 16,9 m²

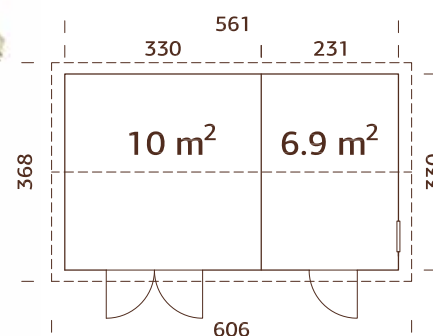

Ready-made wall elements with wind protection plastic!
Trendy look! Fine-sawn cladding.

MODEL SPECIFICATIONS

Wall measurements:

561x330 cm

Volume: 41,5 m³

Door/window type: Summer

Window glass:

Double toughened, 4-9-4 mm

Fixed window, measurements:

50x54 cm

Door opening

measurements:

78x181 cm, 138x181 cm

Door sill: hard wood

Roof boards: 19 mm

Roof area: 22,6 m²

Roof gradient: 15,0°

Gross ground area: 18,5 m²

OPTIONAL

Roofing felt (underlayer): 5 rolls, SBS roofing material: 5 rolls, shingles: 8 packs, roofing nails, rain gutters, additional door and window.

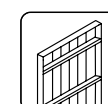

18+70 mm

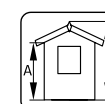

A: 210 cm

B: 261 cm

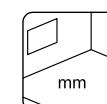

Included

19 mm

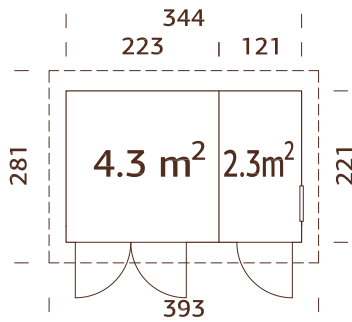
under
2,5mPALMAKO SHED KALLE 6,6 m²

Ready-made wall elements with
wind protection plastic!
Trendy look! Fine-sawn cladding.



MODEL SPECIFICATIONS

Wall measurements:

344x221 cm

Volume: 16,0 m³

Door/window type: Summer

Window glass:

Double toughened, 4-9-4 mm

Fixed window,

measurements:

50x54 cm

Door opening

measurements:

78x181 cm, 138x181 cm

Door sill: hard wood

Roof boards: 19 mm

Roof area: 11,0 m²

Roof gradient: 4,8°

Gross ground area: 7,6 m²

18+70 mm

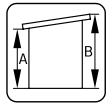

A: 209 cm

B: 249 cm

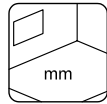

Included

19 mm

OPTIONAL

Roofing felt (underlayer): 2 rolls, SBS roofing material: 2 rolls, roofing nails, EPDM, rain gutters,
additional door and window.

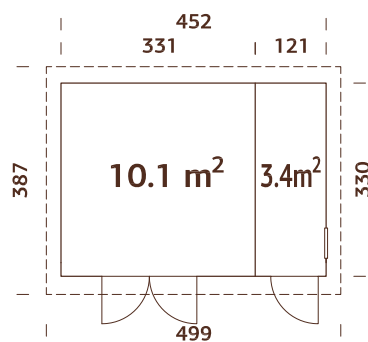
PALMAKO SHED KALLE 13,5 m²

Ready-made wall elements with
wind protection plastic!
Trendy look! Fine-sawn cladding.



Scan this QR-code
to see the assembly
of Kalle 13,5 m²!

MODEL SPECIFICATIONS

Wall measurements:

452x330 cm

Volume: 34,1 m³

Door/window type: Summer

Window glass:

Double toughened, 4-9-4 mm

Fixed window,

measurements:

50x54 cm

Door opening

measurements:

78x181 cm, 138x181 cm

Door sill: hard wood

Roof boards: 19 mm

Roof area: 19,8 m²

Roof gradient: 4,4°

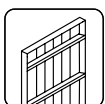
Gross ground area: 14,9 m²

18+70 mm

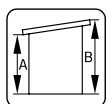

A: 209 cm

B: 259 cm

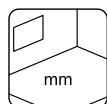

Included

19 mm

OPTIONAL

Roofing felt (underlayer): 3 rolls, SBS roofing material: 3 rolls, roofing nails, EPDM, rain gutters, additional door
and window.

PALMAKO SHED KALLE 16,9 m²

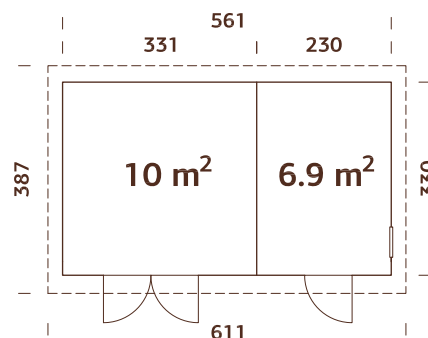

Ready-made wall elements with wind protection plastic!
Trendy look! Fine-sawn cladding.

MODEL SPECIFICATIONS

Wall measurements:

561x330 cm

Volume: 41,5 m³

Door/window type: Summer

Window glass:

Double toughened, 4-9-4 mm

Fixed window, measurements:

50x54 cm

Door opening

measurements:

78x181 cm, 138x181 cm

Door sill: hard wood

Roof boards: 19 mm

Roof area: 23,4 m²

Roof gradient: 4,4°

Gross ground area: 18,5 m²

OPTIONAL

Roofing felt (underlayer): 5 rolls, SBS roofing material: 5 rolls, roofing nails, EPDM, rain gutters, additional door and window.

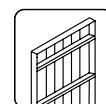

18+70 mm

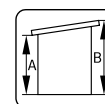

A: 210 cm
B: 259 cm

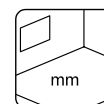

Included
19 mm

PALMAKO KIOSK KIRA 7,7 m²

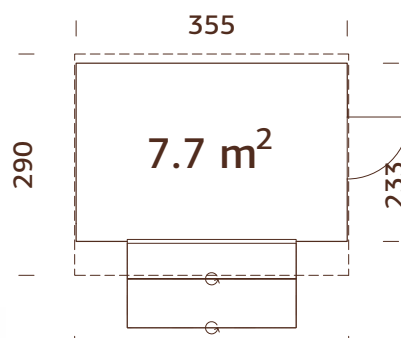

Ready-made wall elements.

MODEL SPECIFICATIONS

Wall measurements:

355x233 cm

Volume: 21,7 m³

Door/window type: Summer

Door opening

measurements: 78x181 cm

Window opening

measurements: 202x103 cm

Roof boards: 19 mm

Roof area: 10,4 m²

Roof gradient: 7,0°

Gross ground area: 8,2 m²

OPTIONAL

Roofing felt (underlayer): 2 rolls, SBS roofing material: 2 rolls, roofing nails, EPDM, rain gutters, additional door and window.

TREATMENT

Available painted

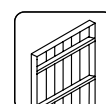

16+32 mm

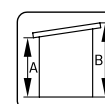

A: 209 cm
B: 264 cm

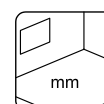

Included
19 mm

PALMAKO KIOSK STELLA 5,0 m²

under
2,5m

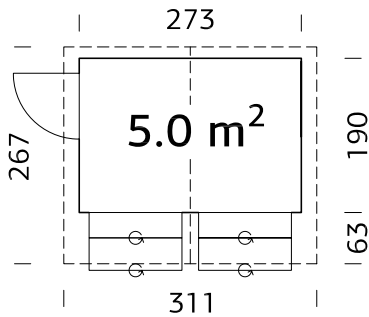

Ready-made wall elements.

TREATMENT

- Available dipped
Available painted



16x32 mm

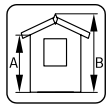

A: 189 cm
B: 229 cm

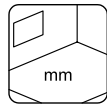

NB! Floor is an optional extra! 16 mm

MODEL SPECIFICATIONS

Wall measurements:

273x190 cm

Volume: 10,2 m³

Window opening measurements:

118x82 cm

Door opening measurements:

76x169 cm

Roof boards: 16 mm

Roof area: 8,5 m²

Roof gradient: 14,6°

Gross ground area: 5,2 m²

OPTIONAL

Floor, roofing felt (underlayer): 2 rolls, SBS roofing material: 2 rolls, shingles: 4 packs, roofing nails.

PALMAKO KIOSK STELLA 8,2 m²

under
2,5m

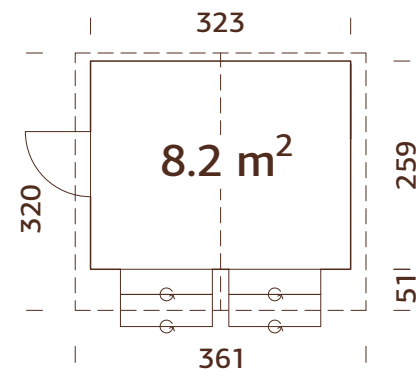

Ready-made wall elements.

TREATMENT

- Available dipped
Available painted

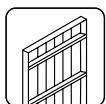

16x32 mm

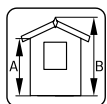

A: 189 cm
B: 239 cm

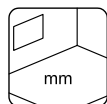

NB! Floor is an optional extra! 16 mm

MODEL SPECIFICATIONS

Wall measurements:

323x259 cm

Volume: 17,7 m³

Window opening measurements:

118x82 cm

Door opening measurements:

76x169 cm

Roof boards: 16 mm

Roof area: 12,0 m²

Roof gradient: 15,0°

Gross ground area: 8,4 m²

OPTIONAL

Floor, roofing felt (underlayer): 2 rolls, SBS roofing material: 2 rolls, shingles: 5 packs, roofing nails.

PALMAKO FOLDING KIOSK MARIAN 6,2 m²

NEW!

under 2,5m



Folded size 2980x2280x765mm
Weight: 600 kg



Can be built in reverse!

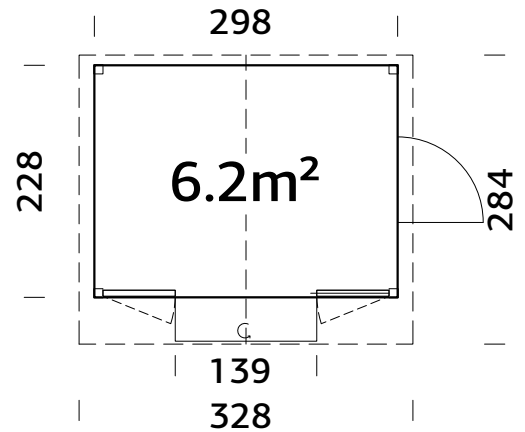

Waterproof PVC canvas as roof covering material included.

TREATMENT

Available painted

MODEL SPECIFICATIONS

Wall measurements: 298x228 cm

Volume: 12,6 m³

Window opening measurements: 118x82 cm

Door opening measurements: 76x169 cm

Roof boards: 16 mm

Roof area: 10,0 m²

Roof gradient: 10,0°

Gross ground area: 6,8 m²

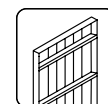

16+32 mm

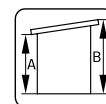

A: 207 cm
B: 245 cm

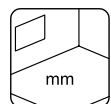

Included
19 mm

FOLDING THE KIOSK FAST & EASY

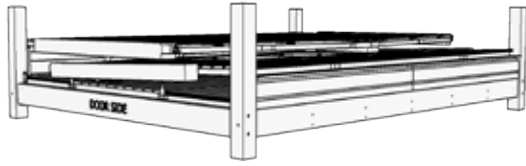

Gather the required tools

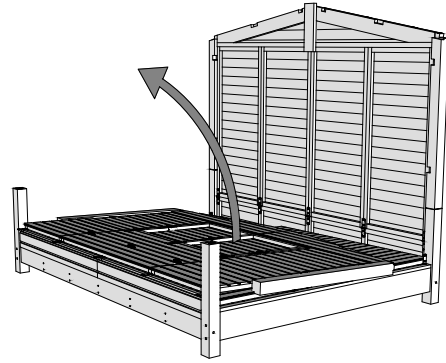
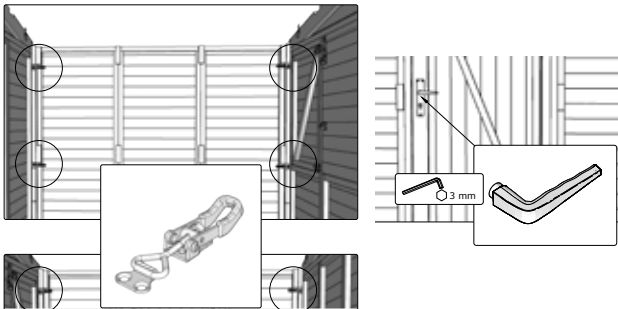

Set up the wall elements

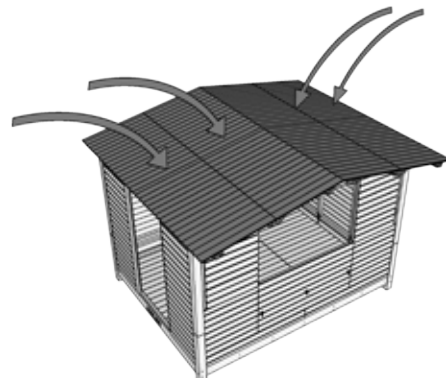

Fasten the tension locks and the door handle

Add the roof elements, secure them with tension locks

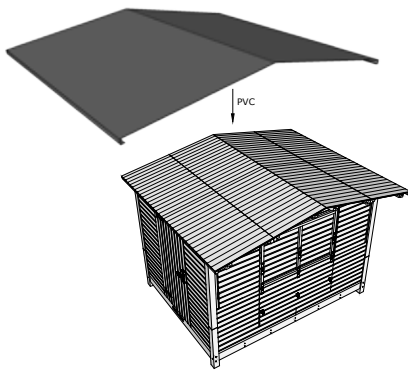

Cover the kiosk with the included waterproof PVC canvas

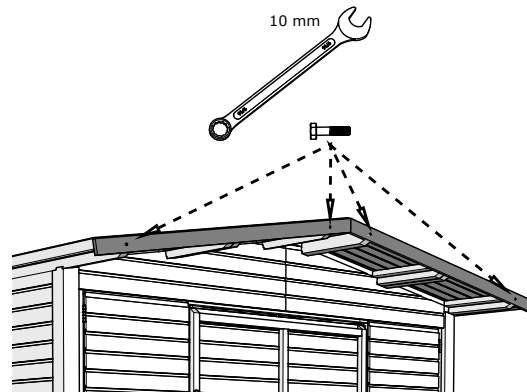

Install the fascia boards



The kiosk is ready for using!

Pre-assembled elements enable quick and easy assembly. After the initial setup, folding and unfolding will take approximately 20 minutes



20 min



OPTIONAL PRODUCTS

SEE OPTIONAL PRODUCTS, PAGES 344-368

House	Art. No.	Floor ¹	Roofing felt, rolls	SBS roofing material, rolls	Shingles ² , packs	Roofing nails, 1 kg	EPDM
Mia 3,6 m ²	101076		107210, 1 roll	107214, 1 roll		107930	111847
Mia 5,4 m ²	101184		107210, 1 roll	107214, 1 roll		107930	111847
Leif 2,2 m ²	101080		107210, 1 roll	107214, 2 rolls		107930	111847
Leif 3,0 m ²	101071		107210, 1 roll	107214, 2 rolls		107930	111847
Leif 4,5 m ²	101081		107210, 1 roll	107214, 1 roll		107930	111847
Leif 3,0+2,9 m ²	110981		107210, 2 rolls	107214, 2 rolls		107930	111847
Leif 4,5+2,9 m ²	111018		107210, 2 rolls	107214, 2 rolls		107930	111847
Dan 4,5 m ²	101176		107210, 1 roll	107214, 1 roll	3 packs	107930	
Dan 7,5 m ²	101198		107210, 2 rolls	107214, 2 rolls	4 packs	107930	
Dan 9,9 m ²	101206		107210, 2 rolls	107214, 2 rolls	5 packs	107930	
Dan 14,7 m ²	101210		107210, 3 rolls	107214, 3 rolls	7 packs	107930	
Nils 5,4 m ²	101180		107210, 2 rolls	107214, 2 rolls	4 packs	107930	
Nils 8,2 m ²	101188		107210, 2 rolls	107214, 2 rolls	5 packs	107930	
Lucas 5,4 m ²	108617		107210, 2 rolls	107214, 2 rolls	5 packs	107930	
Lucas 12,1 m ²	108618		107210, 3 rolls	107214, 3 rolls	7 packs	107930	
Marcus 6,5 m ²	107218		107210, 2 rolls	107214, 2 rolls	5 packs	107930	
Stig 8,2 m ²	110073		107210, 2 rolls	107214, 2 rolls		107930	2 x 111847
Jari 8,9 m ²	101324		107210, 2 rolls	107214, 2 rolls	6 packs	107930	
Jari 14,5 m ²	101358		107210, 5 rolls	107214, 5 rolls	8 packs	107930	

¹Includes treated joists. ² Shingles are available in different colours - 107180 = Black, 107182 = Red, 107183 = Green, 107181 = Brown. The article number is indicated to untreated items, for treated items ask our sales team.



OPTIONAL PRODUCTS

SEE OPTIONAL PRODUCTS, PAGES 344-368

House	Art. No.	Floor ¹	Roofing felt, rolls	SBS roofing material, rolls	Shingles ² , packs	Roofing nails, 1 kg	EPDM	Rain gutters
Martin 8,4 m ²	101066		107210, 2 rolls	107214, 2 rolls	6 packs	107930		106630
Martin 13,6 m ²	101045		107210, 5 rolls	107214, 5 rolls	8 packs	107930		106632
Olaf 6,6 m ²	101229		107210, 2 rolls	107214, 2 rolls	5 packs	107930		106630
Olaf 13,5 m ²	101231		107210, 3 rolls	107214, 3 rolls	8 packs	107930		106632
Olaf 16,9 m ²	101236		107210, 5 rolls	107214, 5 rolls	8 packs	107930		106629 + 106630
Kalle 6,6 m ²	101228		107210, 2 rolls	107214, 2 rolls		107930	2 x 111847	106627
Kalle 13,5 m ²	101232		107210, 3 rolls	107214, 3 rolls		107930	2 x 111847	106628
Kalle 16,9 m ²	101056		107210, 5 rolls	107214, 5 rolls		107930	2 x 111847	106626 + 106627
Kira 7,7 m ²	109668		107210, 2 rolls	107214, 2 rolls		107930	111847	106627
Stella 5,0 m ²	101137	102883	107210, 2 rolls	107214, 2 rolls	4 packs	107930		
Stella 8,2 m ²	101141	102924	107210, 2 rolls	107214, 2 rolls	5 packs	107930		

¹ Includes treated joists. ² Shingles are available in different colours - 107180 = Black, 107182 = Red, 107183 = Green, 107181 = Brown. The article number is indicated to untreated items, for treated items ask our sales team.

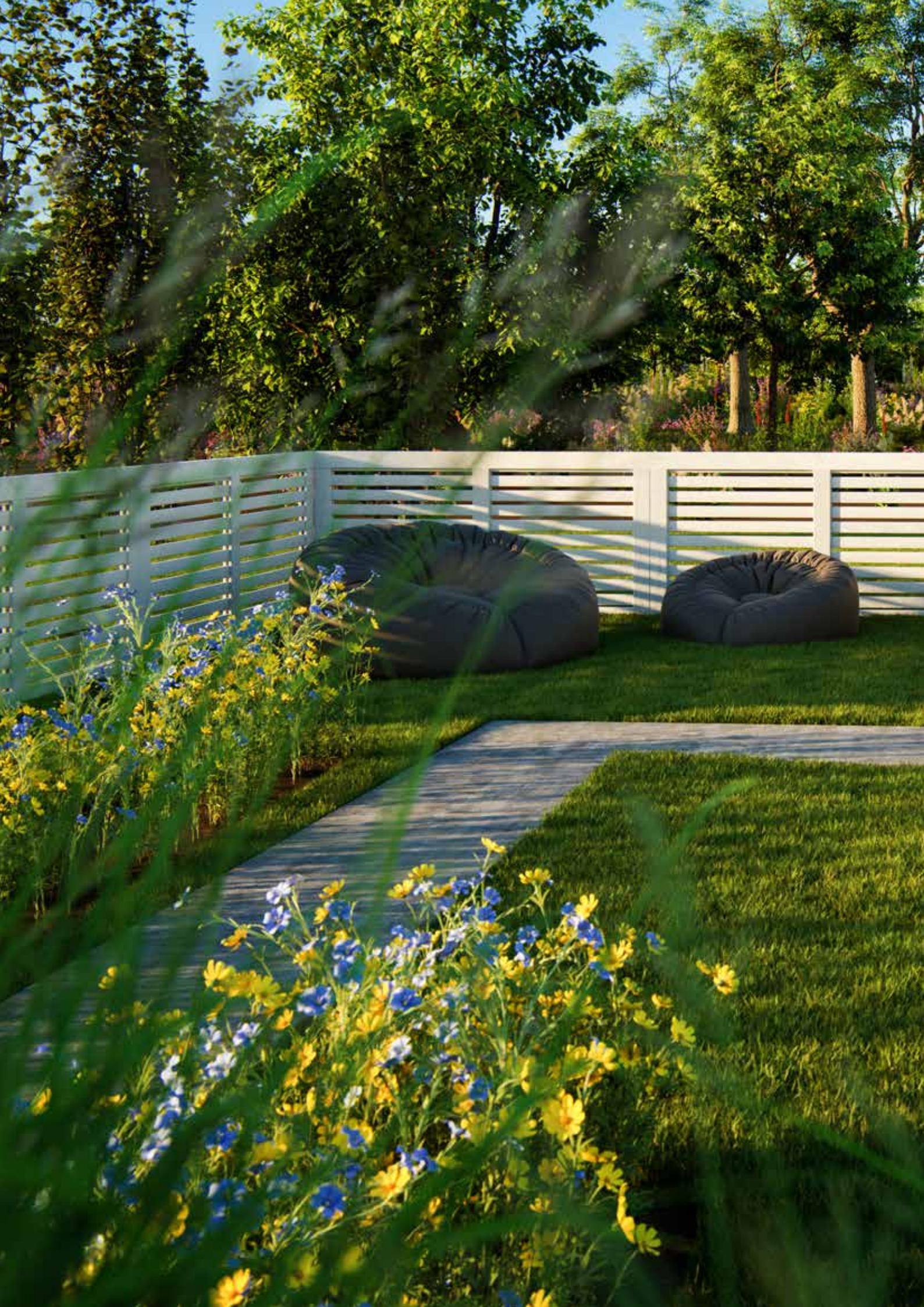



FENCE

PALMAKO FENCE

308-333



PALMAKO FENCE
PANEL LINE 12X17 PALMAKO FENCE
PANEL LINE 12X10



PALMAKO FENCE
PANEL NINA 1 PALMAKO FENCE
PANEL NINA 2 PALMAKO FENCE
PANEL NINA 3 PALMAKO FENCE
PANEL NINA 4 PALMAKO FENCE
PANEL NINA 6



PALMAKO FENCE
PANEL REENA 1 PALMAKO FENCE
PANEL REENA 2 PALMAKO FENCE
PANEL REENA 3 PALMAKO FENCE
PANEL REENA 4 PALMAKO FENCE
PANEL REENA 6 PALMAKO FENCE
PANEL REENA 7 PALMAKO FENCE
PANEL REENA 8

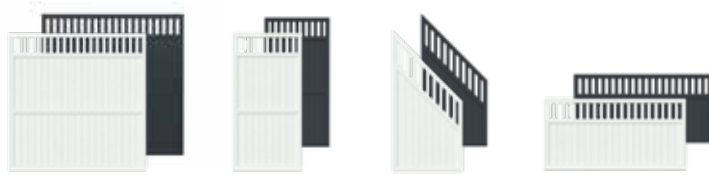

PALMAKO FENCE
PANEL ELKE 1 PALMAKO FENCE
PANEL ELKE 2 PALMAKO FENCE
PANEL ELKE 3 PALMAKO FENCE
PANEL ELKE 4



PALMAKO FENCE
PANEL HELIS 1



PALMAKO FENCE
PANEL HELIS 2



PALMAKO FENCE
PANEL HELIS 3



PALMAKO FENCE
PANEL HELIS 4



PALMAKO FENCE
PANEL HELIS 6



PALMAKO FENCE
PANEL HELIS 7



PALMAKO FENCE
PANEL HELIS 8



PALMAKO FENCE
PANEL MARIT 1



PALMAKO FENCE
PANEL MARIT 2



PALMAKO FENCE
PANEL MARIT 3



PALMAKO FENCE
PANEL MARIT 4



PALMAKO FENCE
PANEL MARIT 6



PALMAKO FENCE
PANEL MARIT 7



PALMAKO FENCE
PANEL MARIT 8



PALMAKO FENCE
PANEL KARINA 1



PALMAKO FENCE
PANEL KARINA 2



PALMAKO FENCE
PANEL KARINA 3



PALMAKO FENCE
PANEL KARINA 4



PALMAKO FENCE
PANEL KARINA 6



PALMAKO FENCE
PANEL JANET 1



PALMAKO FENCE
PANEL JANET 2



PALMAKO FENCE
PANEL BIRGIT 2

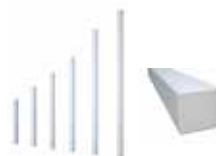

PALMAKO SOLID
WOOD POSTS

PALMAKO FENCE PANELS LINE

SPECIES: SPRUCE

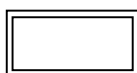
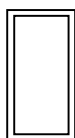

Panel name	Line 12x17	Line 12x10
Article number	● 109559 ● 109558	● 109555 ● 109554
Measurements, W x H	1180x1735 mm	1180x955 mm
Frame profile	32x40 mm	32x40 mm
Board profile	28x45 mm	28x45 mm



All the posts are chamfered on one end.

OPTIONAL

Post legs and fence panel fixing assembly kits.

SOLID WOOD POSTS

Article number	● 100854 ● 100856	● 100860 ● 100862	● 100866 ● 100868	● 100872 ● 100874
Profile	70x70 mm	70x70 mm	70x70 mm	70x70 mm
Length	1000 mm	1300 mm	1600 mm	1900 mm

GLUED LAMINATED POSTS

Article number	● 100902 ● 100903	● 100890 ● 100892	● 100896 ● 100898	● 100917 ● 100918
Profile	90x90 mm	90x90 mm	90x90 mm	90x90 mm
Length	1000 mm	1300 mm	1600 mm	1900 mm

TREATMENT OPTIONS



GYVPI

grey pressure-treated

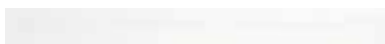

WTPNT1+2

primer + white painted 2 layers (RAL 9016)

PALMAKO FENCE PANELS NINA

SPECIES: SPRUCE

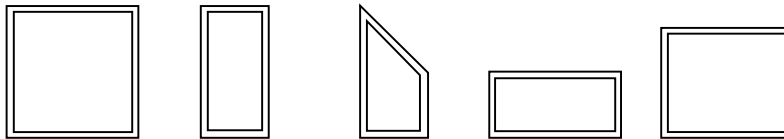

Panel name	Nina 1	Nina 2	Nina 3	Nina 4	Nina 6
Article number	● 109533 ● 109534 ● 109535	● 109472 ● 109473 ● 109474	● 109468 ● 109469 ● 109470	● 109464 ● 109465 ● 109466	● 109461 ● 109462
Measurements, W x H	1800x1800 mm	900x1800 mm	900x1800/900 mm	1800x900 mm	1800x1500 mm
Frame profile	33x57 mm	33x57 mm	33x57 mm	33x57 mm	33x57 mm
Board profile	12x57 mm	12x57 mm	12x57 mm	12x57 mm	12x57 mm



All the posts are chamfered on one end.

OPTIONAL

Post legs and fence panel fixing assembly kits.

SOLID WOOD POSTS

Article number	● 100854 ● 100856 ● 108644	● 100860 ● 100862	● 100866 ● 100868	● 100872 ● 100874 ● 108645
Profile	70x70 mm	70x70 mm	70x70 mm	70x70 mm
Length	1000 mm	1300 mm	1600 mm	1900 mm

GLUED LAMINATED POSTS

Article number	● 100902 ● 100903 ● 108655	● 100890 ● 100892	● 100896 ● 100898	● 100917 ● 100918 ● 108656
Profile	90x90 mm	90x90 mm	90x90 mm	90x90 mm
Length	1000 mm	1300 mm	1600 mm	1900 mm

TREATMENT OPTIONS



GYVPI
grey pressure-treated



WTPNT1+2
primer + white painted 2 layers (RAL 9016)



GYPNT1+2
primer + grey painted 2 layers (RAL7016)

PALMAKO FENCE PANELS REENA

SPECIES: SPRUCE



Panel name	Reena 1	Reena 2	Reena 3	Reena 4	Reena 6	Reena 7	Reena 8
Article number	● 100523 ● 100525 ● 108961	● 100396 ● 100398 ● 108962	● 100402 ● 100404 ● 108963	● 100439 ● 100441 ● 108964	● 100483	● 100356	● 100350
Measurements, W x H	1800x1800 mm	900x1800 mm	900x1800/900 mm	1800x900 mm	1800x1500 mm	900x1500 mm	900x1500/900 mm
Frame profile	33x57 mm	33x57 mm	33x57 mm	33x57 mm	33x57 mm	33x57 mm	33x57 mm
Board profile	12x95 mm	12x95 mm	12x95 mm	12x95 mm	12x95 mm	12x95 mm	12x95 mm
Trellis profile	12x45 mm	12x45 mm	12x45 mm	12x45 mm	12x45 mm	12x45 mm	12x45 mm



All the posts are chamfered on one end.

OPTIONAL

Post legs and fence panel fixing assembly kits.

SOLID WOOD POSTS

Article number	● 100854 ● 100856 ● 108644	● 100860 ● 100862	● 100866 ● 100868	● 100872 ● 100874 ● 108645
Profile	70x70 mm	70x70 mm	70x70 mm	70x70 mm
Length	1000 mm	1300 mm	1600 mm	1900 mm

GLUED LAMINATED POSTS

Article number	● 100902 ● 100903 ● 108655	● 100890 ● 100892	● 100896 ● 100898	● 100917 ● 100918 ● 108656
Profile	90x90 mm	90x90 mm	90x90 mm	90x90 mm
Length	1000 mm	1300 mm	1600 mm	1900 mm

TREATMENT OPTIONS



GYPVI

grey pressure-treated

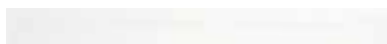

WTPNT1+2

primer + white painted 2 layers (RAL 9016)



GYPNT1+2

primer + grey painted 2 layers (RAL7016)

PALMAKO FENCE PANELS ELKE

SPECIES: SPRUCE

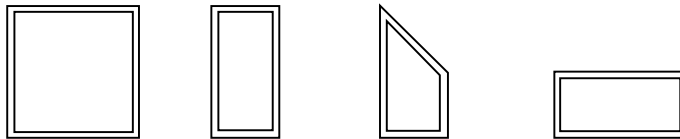

Panel name	Elke 1	Elke 2	Elke 3	Elke 4
Article number	● 100513 ● 108625	● 100386 ● 108626	● 100368 ● 108627	● 107231 ● 108628
Measurements, W x H	1800x1800 mm	900x1800 mm	900x1800/900 mm	1800x900 mm
Frame profile	33x57 mm	33x57 mm	33x57 mm	33x57 mm
Board profile	12x95 mm	12x95 mm	12x95 mm	12x95 mm
Trellis profile	12x45 mm	12x45 mm	12x45 mm	12x45 mm



All the posts are chamfered on one end.

OPTIONAL

Post legs and fence panel fixing assembly kits.

SOLID WOOD POSTS

Article number	● 100856 ● 108644	● 100862	● 100868	● 100874 ● 108645
Profile	70x70 mm	70x70 mm	70x70 mm	70x70 mm
Length	1000 mm	1300 mm	1600 mm	1900 mm

GLUED LAMINATED POSTS

Article number	● 100903 ● 108655	● 100892	● 100898	● 100918 ● 108656
Profile	90x90 mm	90x90 mm	90x90 mm	90x90 mm
Length	1000 mm	1300 mm	1600 mm	1900 mm

TREATMENT OPTIONS

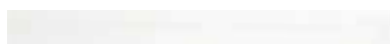

WTPNT1+2

primer + white painted 2 layers (RAL 9016)



GYPNT1+2

primer + grey painted 2 layers (RAL7016)

PALMAKO FENCE PANELS HELIS

SPECIES: SPRUCE

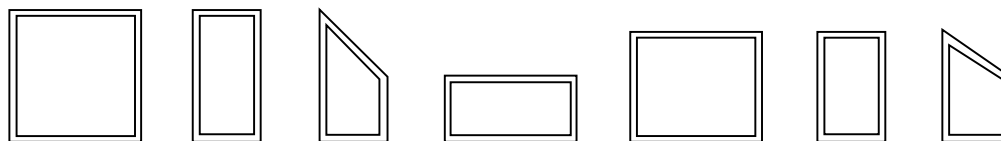

Panel name	Helis 1	Helis 2	Helis 3	Helis 4	Helis 6	Helis 7	Helis 8
Article number	<ul style="list-style-type: none"> ● 100493 ● 100495 ● 100492 ● 108965 	<ul style="list-style-type: none"> ● 100372 ● 100374 ● 100371 ● 108966 	<ul style="list-style-type: none"> ● 100378 ● 100380 ● 100377 ● 108967 	<ul style="list-style-type: none"> ● 100414 ● 100416 ● 100413 ● 108968 	<ul style="list-style-type: none"> ● 100445 ● 100447 ● 100444 	<ul style="list-style-type: none"> ● 100318 ● 100320 ● 100317 	<ul style="list-style-type: none"> ● 100312 ● 100314 ● 100311
Measurements, W x H	1800x1800 mm	900x1800 mm	900x1800/900 mm	1800x900 mm	1800x1500 mm	900x1500 mm	900x1500/900 mm
Frame profile	33x57 mm	33x57 mm	33x57 mm	33x57 mm	33x57 mm	33x57 mm	33x57 mm
Board profile	12x95 mm	12x95 mm	12x95 mm	12x95 mm	12x95 mm	12x95 mm	12x95 mm
Trellis profile	12x45 mm	12x45 mm	12x45 mm	12x45 mm	12x45 mm	12x45 mm	12x45 mm



All the posts are chamfered on one end.

OPTIONAL

Post legs and fence panel fixing assembly kits.

SOLID WOOD POSTS

Article number	<ul style="list-style-type: none"> ● 100854 ● 100856 ● 100853 ● 108644 	<ul style="list-style-type: none"> ● 100860 ● 100862 ● 100859 	<ul style="list-style-type: none"> ● 100866 ● 100868 ● 100865 	<ul style="list-style-type: none"> ● 100872 ● 100874 ● 100871 ● 108645
Profile	70x70 mm	70x70 mm	70x70 mm	70x70 mm
Length	1000 mm	1300 mm	1600 mm	1900 mm

GLUED LAMINATED POSTS

Article number	<ul style="list-style-type: none"> ● 100902 ● 100903 ● 100901 ● 108655 	<ul style="list-style-type: none"> ● 100890 ● 100892 ● 100889 	<ul style="list-style-type: none"> ● 100896 ● 100898 ● 100895 	<ul style="list-style-type: none"> ● 100917 ● 100918 ● 100916 ● 108656
Profile	90x90 mm	90x90 mm	90x90 mm	90x90 mm
Length	1000 mm	1300 mm	1600 mm	1900 mm

TREATMENT OPTIONS



GYVPI
grey pressure-treated



GNVPI
green pressure-treated

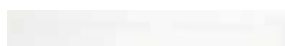

WTPNT1+2
primer + white painted 2 layers
(RAL 9016)



GYPNT1+2
primer + grey painted 2 layers
(RAL7016)

PALMAKO FENCE PANELS MARIT

SPECIES: SPRUCE

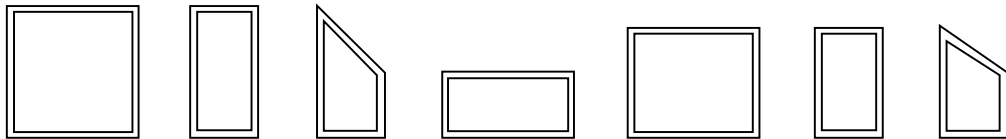

Panel name	Marit 1	Marit 2	Marit 3	Marit 4	Marit 6	Marit 7	Marit 8
Article number	● 100507	● 100374	● 100380	● 100428	● 100465	● 100320	● 100314
Measurements, W x H	1800x1800 mm	900x1800 mm	900x1800/900 mm	1800x900 mm	1800x1500 mm	900x1500 mm	900x1500/900 mm
Frame profile	33x57 mm	33x57 mm	33x57 mm	33x57 mm	33x57 mm	33x57 mm	33x57 mm
Board profile	12x95 mm	12x95 mm	12x95 mm	12x95 mm	12x95 mm	12x95 mm	12x95 mm
Trellis profile	12x45 mm	12x45 mm	12x45 mm	12x45 mm	12x45 mm	12x45 mm	12x45 mm



All the posts are chamfered on one end.

OPTIONAL

Post legs and fence panel fixing assembly kits.

SOLID WOOD POSTS

Article number	● 100856	● 100862	● 100868	● 100874
Profile	70x70 mm	70x70 mm	70x70 mm	70x70 mm
Length	1000 mm	1300 mm	1600 mm	1900 mm

GLUED LAMINATED POSTS

Article number	● 100903	● 100892	● 100898	● 100918
Profile	90x90 mm	90x90 mm	90x90 mm	90x90 mm
Length	1000 mm	1300 mm	1600 mm	1900 mm

TREATMENT OPTIONS

WTPNT1+2

primer + white painted 2 layers (RAL 9016)

PALMAKO FENCE PANELS KARINA

SPECIES: SPRUCE

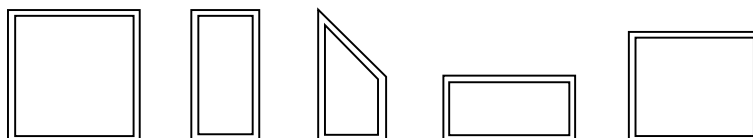

Panel name	Karina 1	Karina 2	Karina 3	Karina 4	Karina 6
Article number	● 100499 ● 100501	● 100362	● 100368	● 100420 ● 100422	● 100457 ● 100459
Measurements, W x H	1800x1800 mm	900x1800 mm	900x1800/900 mm	1800x900 mm	1800x1500 mm
Frame profile	33x57 mm	33x57 mm	33x57 mm	33x57 mm	33x57 mm
Board profile	12x95 mm	12x95 mm	12x95 mm	12x95 mm	12x95 mm
Trellis profile	12x45 mm	12x45 mm	12x45 mm	12x45 mm	12x45 mm



All the posts are chamfered on one end.

OPTIONAL

Post legs and fence panel fixing assembly kits.

SOLID WOOD POSTS

Article number	● 100854 ● 100856	● 100860 ● 100862	● 100866 ● 100868	● 100872 ● 100874
Profile	70x70 mm	70x70 mm	70x70 mm	70x70 mm
Length	1000 mm	1300 mm	1600 mm	1900 mm

GLUED LAMINATED POSTS

Article number	● 100902 ● 100903	● 100890 ● 100892	● 100896 ● 100898	● 100917 ● 100918
Profile	90x90 mm	90x90 mm	90x90 mm	90x90 mm
Length	1000 mm	1300 mm	1600 mm	1900 mm

TREATMENT OPTIONS



GYVPI

grey pressure-treated

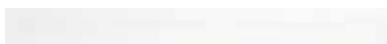

WTPNT1+2

primer + white painted 2 layers (RAL 9016)

PALMAKO FENCE PANELS JANET / BIRGIT

SPECIES: SPRUCE

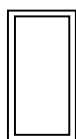
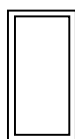
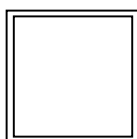

JANET 1

JANET 2

BIRGIT 2

Panel name	Janet 1	Janet 2	Birgit 2
Article number	● 107663	● 107669	● 107675
Measurements, W x H	1800x1800 mm	900x1800 mm	900x1800 mm
Frame profile	33x57 mm	33x57 mm	33x57 mm
Board profile	12x85 mm	12x85 mm	

Can be combined with other fence panels series, see p. 312-318.

These fence panels have 6 mm toughened glass.

OPTIONAL

Post legs and fence panel fixing assembly kits.



All the posts are chamfered on one end.

SOLID WOOD POSTS

Article number	● 100856	● 100862	● 100868	● 100874
Profile	70x70 mm	70x70 mm	70x70 mm	70x70 mm
Length	1000 mm	1300 mm	1600 mm	1900 mm

GLUED LAMINATED POSTS

Article number	● 100903	● 100892	● 100898	● 100918
Profile	90x90 mm	90x90 mm	90x90 mm	90x90 mm
Length	1000 mm	1300 mm	1600 mm	1900 mm

TREATMENT OPTIONS

WTPNT1+2









primer + white painted 2 layers (RAL 9016)

CREATE YOUR OWN GARDEN STORY WITH PALMAKO FENCE PANELS

If your garden misses elegant and airy fence panels, be ready to meet our Fence panels selection. Surrounding your city garden or terrace with fence panels is so easy and a refreshing way to give your favourite place to be a unique and modern look.

We have nine different designs within our fence panel collection so you can pick your favourite or why not combine different designs according to your needs. All our fence panels have 33x57 mm or 32x40 mm frame which makes them easily manageable and show that your garden has been nicely taken care of.

Please get familiar with designs as follows:

	Line Horizontal with gaps.		Marit Horizontal with gaps and two vertical rails. Vertical trellis with three crosses.
	Nina Horizontal with gaps.		Karina Vertical with rail in the middle. Vertical trellis with three crosses.
	Reena Vertical with rail in the middle. Horizontal trellis.		Janet Vertical boards with 6 mm bright toughened glass.
	Elke Vertical with rail in the middle. Vertical trellis.		Birgit 6 mm bright toughened glass in a solid wood frame.
	Helis Horizontal with gaps and two vertical rails. Vertical trellis with one cross.		

Depending on model, one can choose between ten dimensions:

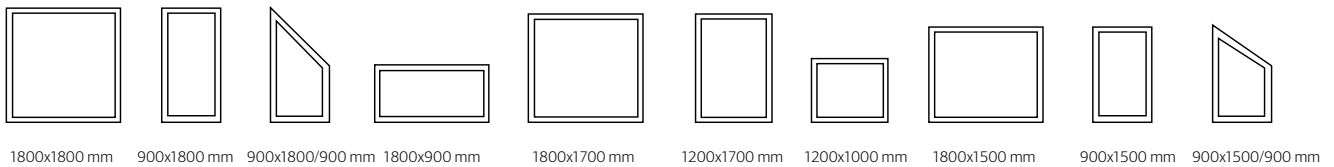

And depending on model one can choose between different treatments which suits the best into the garden interior:



grey pressure-treated



green pressure-treated



primer+white painted 2 layers (RAL 9016)



primer+grey painted 2 layers (RAL7016)

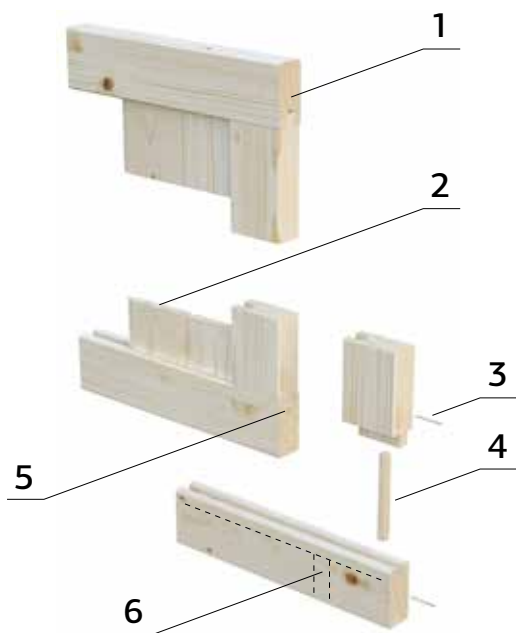

1. Frame profile 33x57 mm
2. Board profile 12x95 mm
3. Brad nails
4. Dowel 10x130 mm
5. Water channel
6. Drainage hole to let out any built up moisture or water

All our fence panels can be easily assembled. If you look at the visual of assembling a fence panel below, you will see which products you need and how to assemble them together.

See Optional Products on p. 355 for details.



1. Fence panel
2. Post
3. Post leg
4. Screws
5. L-type fastening brackets
6. Post cap

Fixings to the ground should be done properly according to the foundation. Please get appropriate fixing items from the DIY-store.



Scan this QR-code to see the assembly of Palmako Fence Panels!

All fence panels are made of Nordic spruce which is dense, strong, durable and has small knots.

FENCE



PALMAKO FENCE
ELEMENT LOVISA 10



PALMAKO FENCE
ELEMENT LUISE 10



PALMAKO FENCE
ELEMENT KAMILLA 10

NEW



PALMAKO FENCE
ELEMENT KELDA 8



PALMAKO FENCE
ELEMENT KELDA 10



PALMAKO GATE
LOVISA 10



PALMAKO GATE
LUISE 10



PALMAKO GATE
KAMILLA 10

NEW



PALMAKO GATE
KELDA 8



PALMAKO GATE
KELDA 10



PALMAKO FENCE FOR
TERRACE SIRI 11



PALMAKO FENCE FOR
STAIRS SIRI 17



PALMAKO FENCE FOR
TERRACE SIRI 11 GLASS



PALMAKO FENCE FOR
TERRACE SIRI 6 GLASS



PALMAKO POSTS FOR
TERRACE FENCE

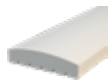

PALMAKO HANDRAILS
FOR TERRACE FENCE



PALMAKO FENCE PANEL
LAUREEN



PALMAKO GLUED
LAMINATED POSTS



PALMAKO POSTSAVER
PROTECTED POSTS



PALMAKO PREMIUM
MACHINE ROUNDED POSTS



PALMAKO PREMIUM
MACHINE ROUNDED POLES

PALMAKO FENCE

308-333

PALMAKO FENCE ELEMENT LOVISA 10

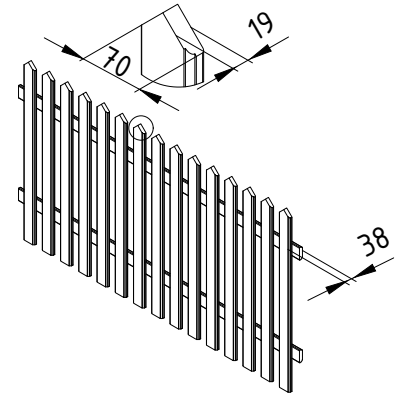

MODEL SPECIFICATIONS

Element measurements,
width x height: 1800x1000 mm
Depth: 38 mm
Palisade profile: 19x70 mm

TREATMENT



108639
primer + white painted 2 layers (RAL 9016)

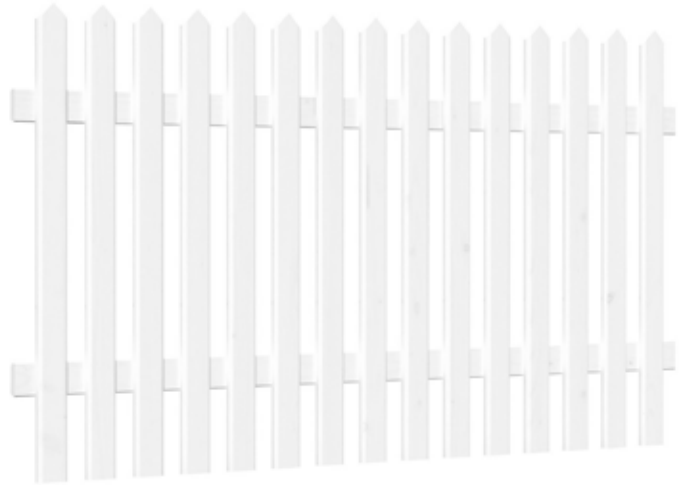

PALMAKO GATE LOVISA 10

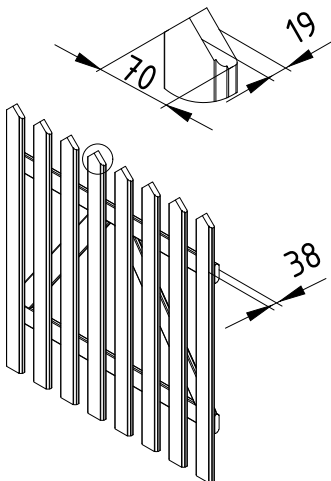

TREATMENT

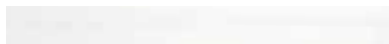

109035
primer + white painted 2 layers (RAL 9016)

OPTIONAL

Fence gate hardware kit.

MODEL SPECIFICATIONS

Element measurements,
width x height: 900x1000 mm
Depth: 38 mm
Palisade profile: 19x70 mm

PALMAKO FENCE ELEMENT LUISE 10

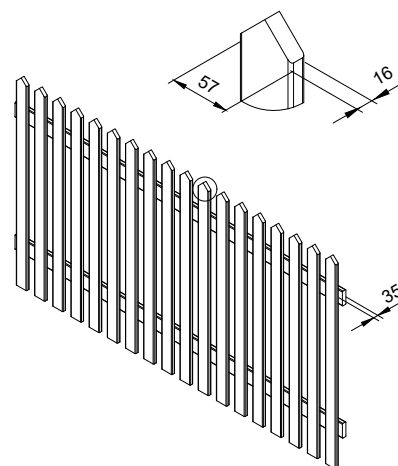

MODEL SPECIFICATIONS

Element measurements,
width x height: 1800x1000 mm
Depth: 35 mm
Palisade profile: 16x57 mm

TREATMENT OPTIONS



100546
 green pressure-treated

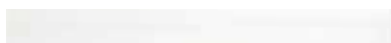

100549
 primer+white painted 2 layers (RAL 9016)

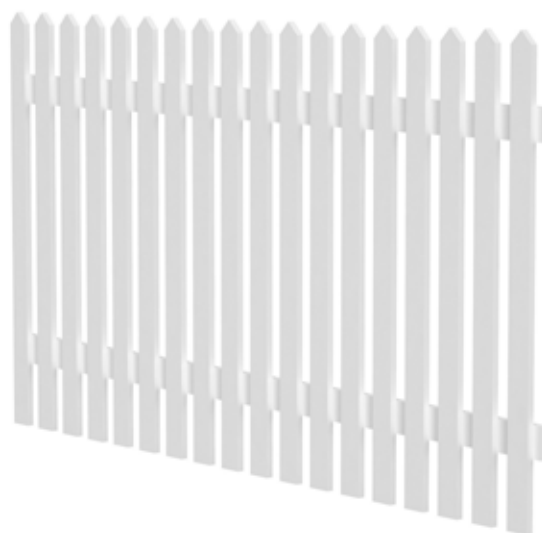

PALMAKO GATE LUISE 10

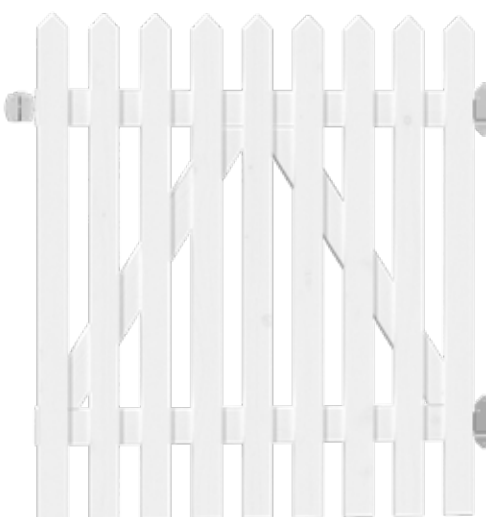
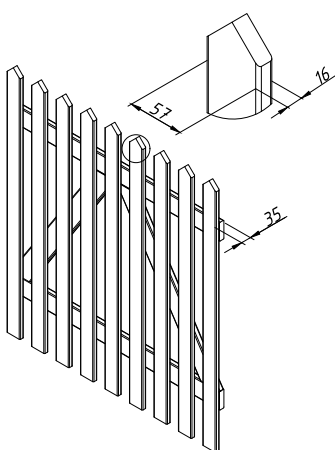

TREATMENT OPTIONS



107909
 green pressure-treated

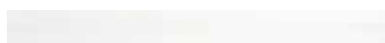

107913
 primer + white painted 2 layers (RAL 9016)

OPTIONAL

Fence gate hardware kit.

MODEL SPECIFICATIONS

Element measurements,
width x height: 900x1000 mm
Depth: 35 mm
Palisade profile: 16x57 mm

PALMAKO FENCE ELEMENT KAMILLA 10

NEW!

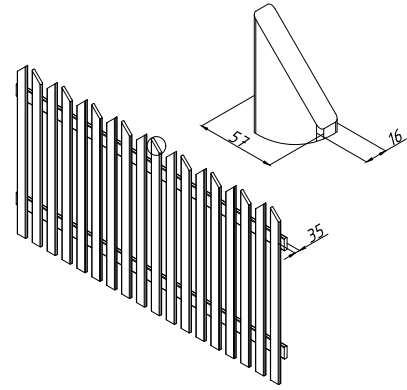

MODEL SPECIFICATIONS

Element measurements,
width x height: 1800x1000 mm

Depth: 35 mm

Palisade profile: 16x57 mm

TREATMENT

119374

primer+white painted 2 layers (RAL 9016)



PALMAKO GATE KAMILLA 10

NEW!

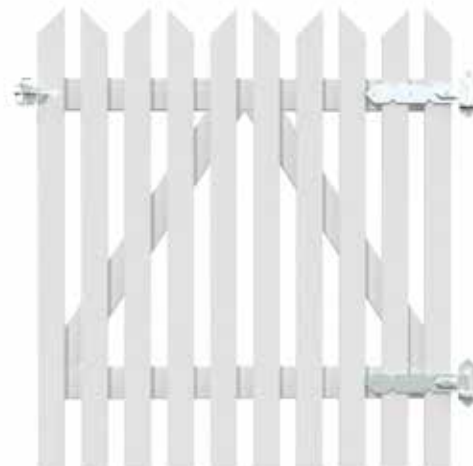
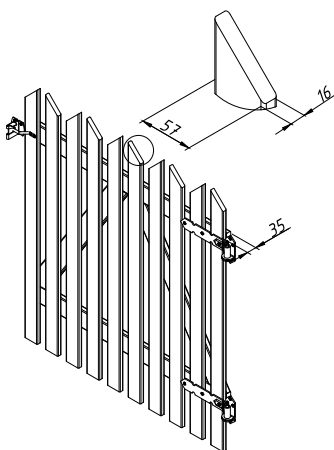

TREATMENT

107913

primer + white painted 2 layers (RAL 9016)

OPTIONAL

Fence gate hardware kit.

MODEL SPECIFICATIONS

Element measurements,

width x height: 900x1000 mm

Depth: 35 mm

Palisade profile: 16x57 mm

PALMAKO FENCE ELEMENT KELDA 8

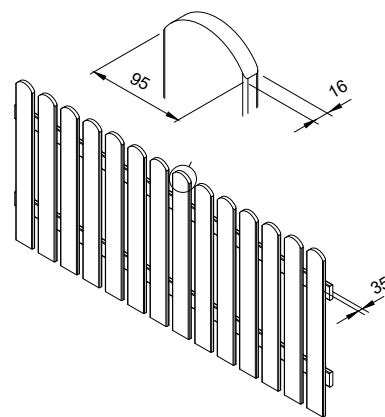

MODEL SPECIFICATIONS

Element measurements,
width x height: 1800x800 mm
Depth: 35 mm
Palisade profile: 16x95 mm

TREATMENT OPTIONS



100534
 green pressure-treated

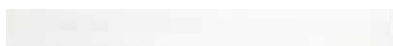

100537
 primer + white painted 2 layers (RAL 9016)

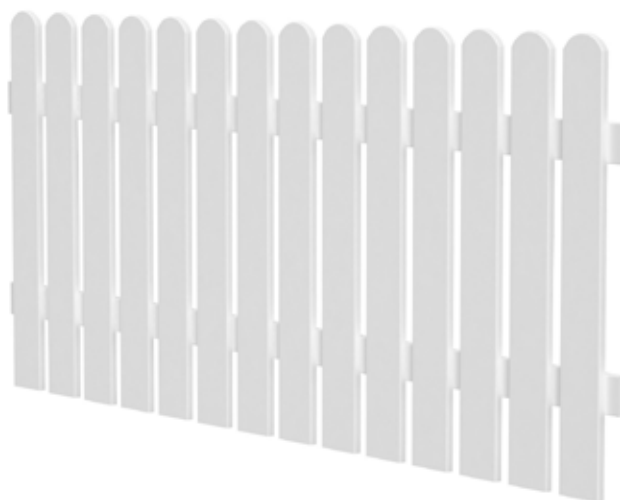

PALMAKO GATE KELDA 8

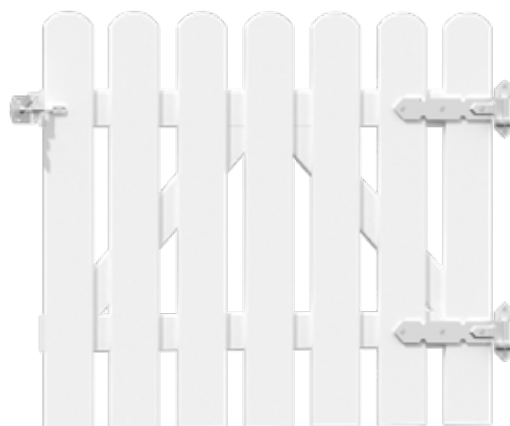
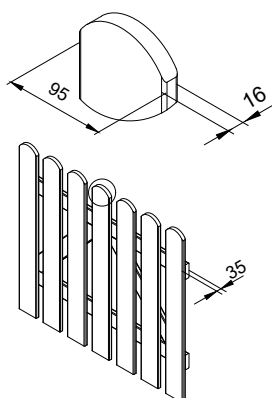

TREATMENT OPTIONS



108333
 green pressure-treated

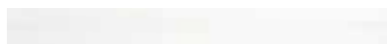

108334
 primer + white painted 2 layers (RAL 9016)

OPTIONAL

Fence gate hardware kit.

MODEL SPECIFICATIONS

Element measurements,
width x height: 900x800 mm
Depth: 35 mm
Palisade profile: 16x95 mm

PALMAKO FENCE ELEMENT KELDA 10

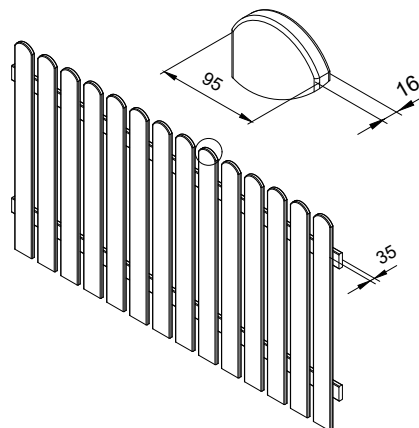

MODEL SPECIFICATIONS

Element measurements,
width x height: 1800x1000 mm
Depth: 35 mm
Palisade profile: 16x95 mm

TREATMENT

100543

primer + white painted 2 layers (RAL 9016)

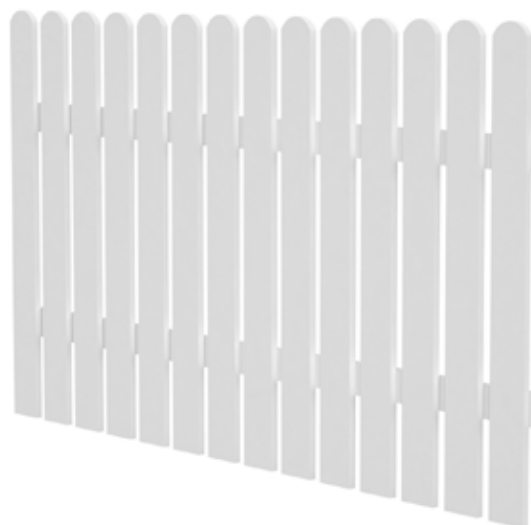

PALMAKO GATE KELDA 10

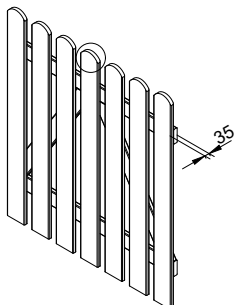
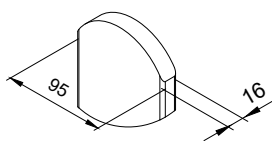

TREATMENT

107907

primer + white painted 2 layers (RAL 9016)

OPTIONAL

Fence gate hardware kit.

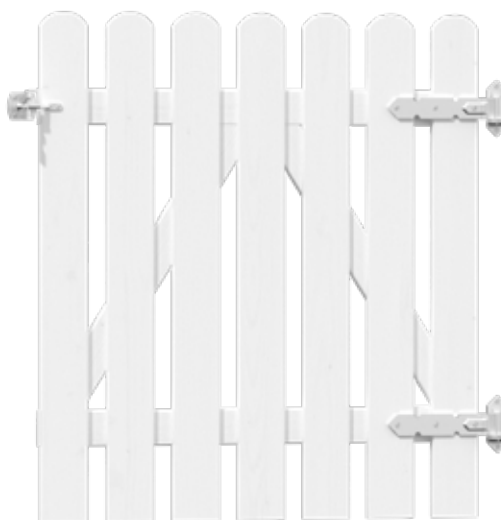

MODEL SPECIFICATIONS

Element measurements,
width x height: 900x1000 mm
Depth: 35 mm
Palisade profile: 16x95 mm

PALMAKO FENCE FOR TERRACE SIRI 11

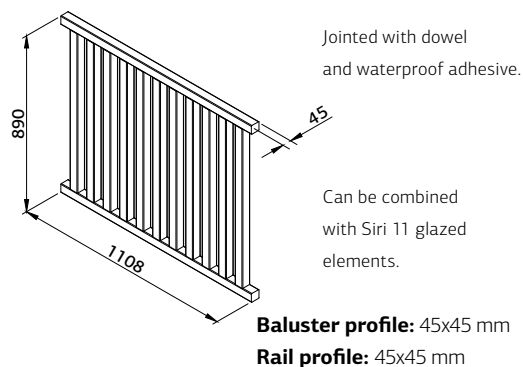

TREATMENT

100555

primer + white painted 2 layers
(RAL 9016)

PALMAKO FENCE FOR STAIRS SIRI 17

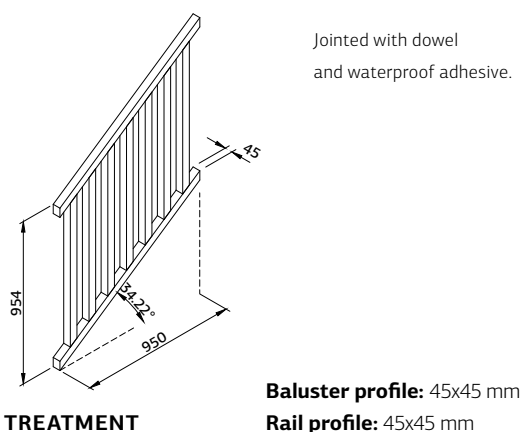

TREATMENT

100561

primer + white painted 2 layers (RAL 9016)

POSTS AND HANDRAILS

POSTS FOR TERRACE FENCE

Article number	● 100844
Profile	45x70 mm
Length	1200 mm

TREATMENT

WTPNT1+2

primer + white painted 2 layers
(RAL 9016)

HANDRAILS FOR TERRACE FENCE

SPECIES: PINE

Article number	● 100820	● 100832
Profile	34x120 mm	34x145 mm
Length	4200 mm	4200 mm
	curved	curved

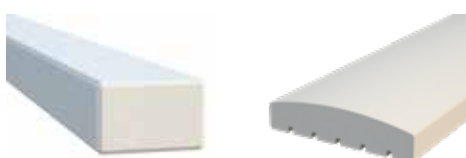

PALMAKO FENCE FOR TERRACE, SIRI 11 GLASS

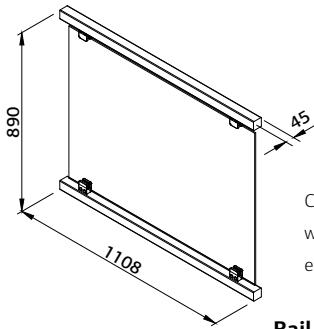

Can be combined with Siri 11 wooden elements.

Rail profile: 45x45 mm

Glass: clear toughened glass, 6 mm

TREATMENT



107693

primer + white painted 2 layers (RAL 9016)



PALMAKO FENCE FOR TERRACE, SIRI 6 GLASS

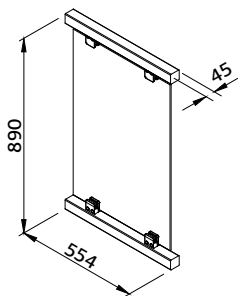

Can be combined with Siri 11 wooden elements.

Rail profile: 45x45 mm

Glass: clear toughened glass, 6 mm

TREATMENT



107705

primer + white painted 2 layers (RAL 9016)



POSTS AND HANDRAILS

POSTS FOR TERRACE FENCE

Article number	● 100844
Profile	45x70 mm
Length	1200 mm

TREATMENT



WTPNT1+2

primer + white painted 2 layers (RAL 9016)

HANDRAILS FOR TERRACE FENCE

SPECIES: PINE

Article number	● 100820	● 100832
Profile	34x120 mm	34x145 mm
Length	4200 mm	4200 mm
	curved	curved

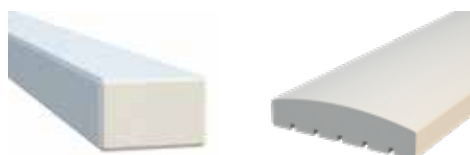

PALMAKO FENCE PANEL LAUREEN

SPECIES: SPRUCE



MODEL SPECIFICATIONS

Panel measurements,
width x height: 1800x1800 mm
Depth: 82 mm

TREATMENT OPTIONS



100748
grey pressure-treated

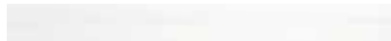

100749
primer + white painted 2 layers (RAL 9016)



108986
primer + grey painted 2 layers (RAL7016)



PALMAKO POLE BASE AND FENCE PANEL FASTENERS



**Post leg with pile
90x90 mm hot dip**
Art. No.: 106617



**Post leg with pile
70x70 mm hot dip**
Art. No.: 107487



**Post leg rectangular plate
90x90 mm hot dip**
Art. No.: 106613



**Post leg side support
70x70 mm hot dip**
Art. No.: 107492



**Post leg side support
70x70 mm white**
Art. No.: 107493



**Post leg side support
90x90 mm hot dip**
Art. No.: 107494



**Post leg side support
90x90 mm white**
Art. No.: 107495



**Post leg corner
hot dip**
Art. No.: 107489



**Post leg corner
white**
Art. No.: 107488

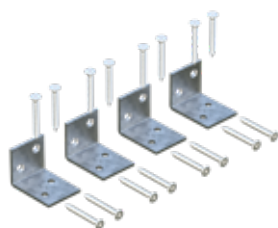

**L-type fastening brackets
(set 4 pcs) hot dip**
Art. No.: 108424

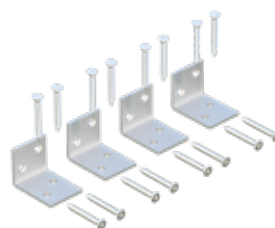

**L-type fastening brackets
(set 4 pcs) white**
Art. No.: 108423



**Wooden screws
(set 8 pcs) hot dip**
Art. No.: 120373



**Wooden screws
(set 8 pcs) white**
Art. No.: 107486



**Fence gate
hardware kit**
Art. No.: 108303



**Post cap
70x70 mm white**
Art. No.: 108300

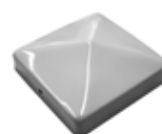

**Post cap
90x90 mm white**
Art. No.: 108302

PALMAKO POSTSAVER PROTECTED POSTS



	Art. No.	Diameter, mm	Length, mm	Treatment	Processing	Species	Split yes/no	Pieces/pack	FSC
Post Postsaver 75 1800	106599	75	1800	GNVPIH4 green pressure-treated HC4	PC	spruce	No	168	FSC Mix Credit
Post Postsaver 75 2400	108284	75	2400	GNVPIH4 green pressure-treated HC4	PC	spruce	No	168	FSC Mix Credit
Post Postsaver 85 1800	106601	85	1800	GNVPIH4 green pressure-treated HC4	PC	spruce	No	132	FSC Mix Credit
Post Postsaver 85 2400	108285	85	2400	GNVPIH4 green pressure-treated HC4	PC	spruce	No	132	FSC Mix Credit
Post Postsaver 100 1800	106602	100	1800	GNVPIH4 green pressure-treated HC4	PC	spruce	No	90	FSC Mix Credit
Post Postsaver 100 2400	108287	100	2400	GNVPIH4 green pressure-treated HC4	PC	spruce	No	90	FSC Mix Credit
Post Postsaver 140 2400	109561	140	2400	GNVPIH4 green pressure-treated HC4	PC	pine	No	49	FSC Mix Credit

DESCRIPTION

End processing: Pointed & Chamfered (PC)

Surface: Incised

Treatment chemical: Impralit®-KDS; Colour green

Treatment method: Vacuum-pressure-vacuum

Treatment class: HC4; Pre-dried below 35% of moisture content

Treatment standard: EN351-1 (penetration ≥ 6mm)

Postsaver: Double layer sleeve applied to the ground level point

Warranty: 25 years (ask for terms)

PALMAKO PREMIUM MACHINE ROUNDED POSTS



	Art. No.	Diameter, mm	Length, mm	Treatment	Processing	Species	Split yes/no	Pieces/pack	FSC
Post Premium 60 1500	101266	60	1500	GNVPIH4 green pressure-treated HC4	PC	spruce	No	238	FSC Mix Credit
Post Premium 60 1800	108289	60	1800	GNVPIH4 green pressure-treated HC4	PC	spruce	No	238	FSC Mix Credit
Post Premium 75 1650	108290	75	1650	GNVPIH4 green pressure-treated HC4	PC	spruce	No	168	FSC Mix Credit
Post Premium 75 1800	108291	75	1800	GNVPIH4 green pressure-treated HC4	PC	spruce	No	168	FSC Mix Credit
Post Premium 75 2400	108293	75	2400	GNVPIH4 green pressure-treated HC4	PC	spruce	No	168	FSC Mix Credit
Post Premium 80 2000	101273	80	2000	GNVPIH4 green pressure-treated HC4	PC	pine	No	143	FSC Mix Credit
Post Premium 80 2500	101275	80	2500	GNVPIH4 green pressure-treated HC4	PC	pine	No	143	FSC Mix Credit
Post Premium 80 3000	109116	80	3000	GNVPIH4 green pressure-treated HC4	PC	pine	No	143	FSC Mix Credit
Post Premium 85 1650	108294	85	1650	GNVPIH4 green pressure-treated HC4	PC	spruce	No	132	FSC Mix Credit
Post Premium 85 1800	108295	85	1800	GNVPIH4 green pressure-treated HC4	PC	spruce	No	132	FSC Mix Credit
Post Premium 85 2400	108364	85	2400	GNVPIH4 green pressure-treated HC4	PC	spruce	No	132	FSC Mix Credit
Post Premium 100 1800	101280	100	1800	GNVPIH4 green pressure-treated HC4	PC	spruce	No	90	FSC Mix Credit
Post Premium 100 2000	101282	100	2000	GNVPIH4 green pressure-treated HC4	PC	pine	No	90	FSC Mix Credit
Post Premium 100 2400	108298	100	2400	GNVPIH4 green pressure-treated HC4	PC	spruce	No	90	FSC Mix Credit
Post Premium 100 2500	101285	100	2500	GNVPIH4 green pressure-treated HC4	PC	pine	No	90	FSC Mix Credit
Post Premium 100 3000	101287	100	3000	GNVPIH4 green pressure-treated HC4	PC	spruce	No	90	FSC Mix Credit
Post Premium 140 2100	120451	140	2100	GNVPIH4 green pressure-treated HC4	PC	pine	No	49	FSC Mix Credit
Post Premium 140 2400	109560	140	2400	GNVPIH4 green pressure-treated HC4	PC	pine	No	49	FSC Mix Credit
Post Premium 150 2400	101293	150	2400	GNVPIH4 green pressure-treated HC4	PC	pine	No	42	FSC Mix Credit

DESCRIPTION

End processing: Pointed & Chamfered (PC)

Surface: Spruce surface incised

Treatment chemical: Impralit®-KDS; Colour green

Treatment method: Vacuum-pressure-vacuum

Treatment class: HC4; Pre-dried below 35% (spruce) or 28% (pine) of moisture content

Treatment standard: EN351-1

Warranty: 15 years (ask for terms)

USAGE

Fence and gate posts, wire or rail fencing, electric fencing, playground structures, ground works



PALMAKO PREMIUM MACHINE ROUNDED POLES

	Art. No.	Diameter, mm	Length, mm	Treatment	Processing	Species	Split yes/no	Pieces/pack	FSC
Pole Premium 80 2500	101274	80	2500	GNVPIH4 green pressure-treated HC4	CC	pine	No	143	FSC Mix Credit
Pole Premium 80 3000	101276	80	3000	GNVPIH4 green pressure-treated HC4	CC	pine	No	143	FSC Mix Credit
Pole Premium 80 4000	101277	80	4000	GNVPIH4 green pressure-treated HC4	CC	pine	No	143	FSC Mix Credit
Pole Premium 100 2000	101281	100	2000	GNVPIH4 green pressure-treated HC4	CC	pine	No	90	FSC Mix Credit
Pole Premium 100 3000	101286	100	3000	GNVPIH4 green pressure-treated HC4	CC	pine	No	90	FSC Mix Credit
Pole Premium 100 4000	101288	100	4000	GNVPIH4 green pressure-treated HC4	CC	pine	No	90	FSC Mix Credit
Pole Premium 120 3000	101291	120	3000	GNVPIH4 green pressure-treated HC4	CC	pine	No	64	FSC Mix Credit
Pole Premium 120 4000	108288	120	4000	GNVPIH4 green pressure-treated HC4	CC	pine	No	64	FSC Mix Credit

DESCRIPTION

End processing: Chamfered & Chamfered (CC)

Surface: Spruce surface incised

Treatment chemical: Impralit®-KDS; Colour green

Treatment method: Vacuum-pressure-vacuum

Treatment class: HC4; Pre-dried below 35% (spruce) or 28% (pine) of moisture content

Treatment standard: EN351-1

Warranty: 15 years (ask for terms)

USAGE

Wire or rail fencing,
playground structures,
structural poles



**Palmako Postsaver
Protected posts**



**Palmako Premium Machine
Rounded Posts**



**Palmako Premium Machine
Rounded Poles**





FURNITURE, GARDENING & OTHER



PALMAKO TABLE WITH
BENCHES SANNE 18



PALMAKO HANGING
BENCH SIGRID



PALMAKO
PICNIC TABLE RUBY 18



PALMAKO
PICNIC TABLE RUBY 24



PALMAKO TABLE WITH
BENCHES ARTHUR



PALMAKO TABLE WITH
BENCHES OSCAR



PALMAKO GARDEN
FURNITURE SET LEO



PALMAKO GARDEN
FURNITURE SET ARON



PALMAKO FLOWERBOX
MELISSA 4



PALMAKO FLOWERBOX
MELISSA 7



PALMAKO FLOWERBOX
MELISSA 10



PALMAKO
LOG ROLLS



PALMAKO HEAT PUMP COVER
EDWIN

PALMAKO TABLE WITH BENCHES SANNE 18

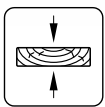
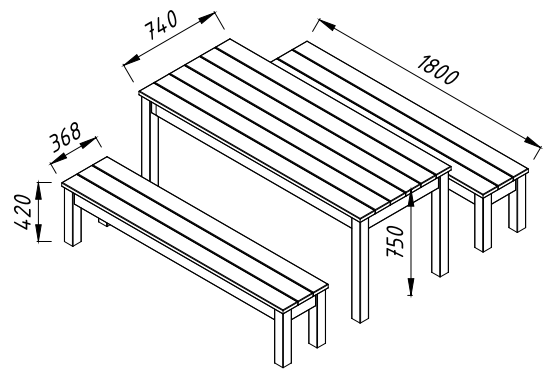

28 mm

MODEL SPECIFICATIONS

Measurements:

180x74 cm (table), 180x37 cm (benches)

Height:

75 cm (table), 42 cm (benches)

TREATMENT



green pressure-treated

PALMAKO HANGING BENCH SIGRID

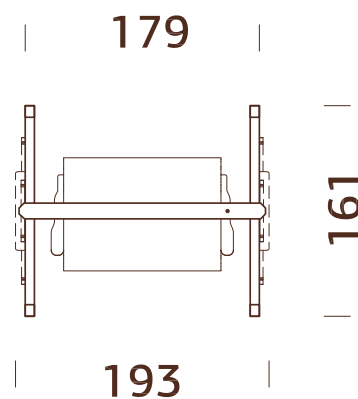

MODEL SPECIFICATIONS

Measurements: 193x161 cm

Height: 198 cm

TREATMENT



green pressure-treated

PALMAKO PICNIC TABLE RUBY 18

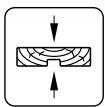
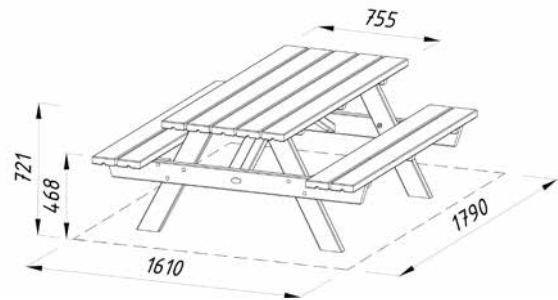

44 mm

MODEL SPECIFICATIONS

Measurements: 179x161 cm

Height: 72 cm

TREATMENT



green pressure-treated

PALMAKO PICNIC TABLE RUBY 24

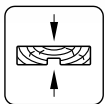
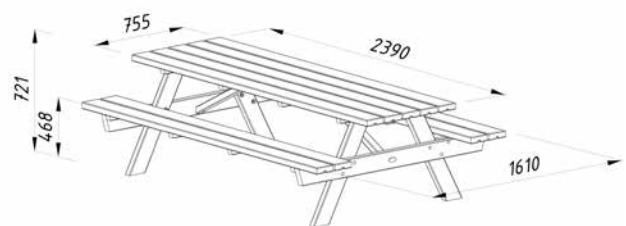

44 mm

MODEL SPECIFICATIONS

Measurements: 239x161 cm

Height: 72 cm

TREATMENT



green pressure-treated

PALMAKO TABLE WITH BENCHES ARTHUR

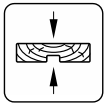
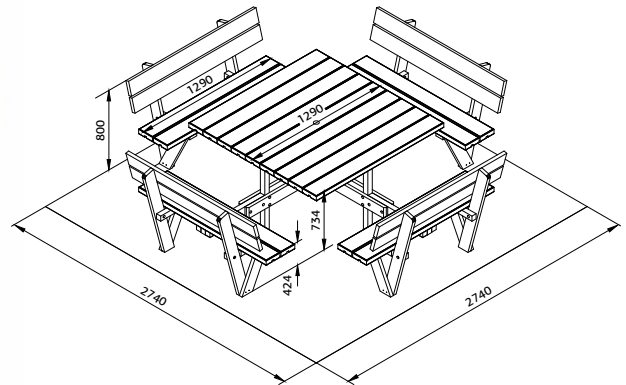

44 mm

MODEL SPECIFICATIONS

Measurements: 274x274 cm

Height: 73 cm

TREATMENT



green pressure-treated

PALMAKO TABLE WITH BENCHES OSCAR

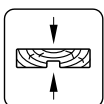
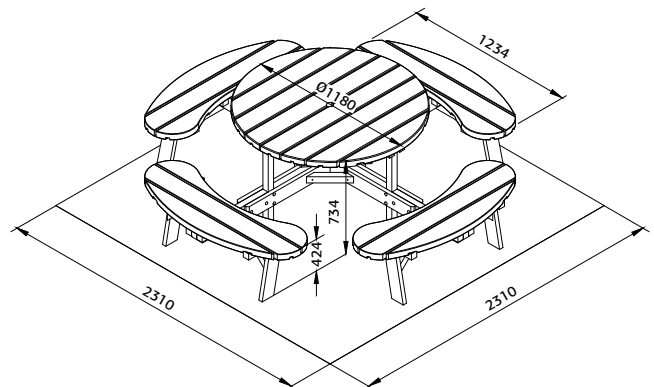

44 mm

MODEL SPECIFICATIONS

Measurements: 231x231 cm

Height: 73 cm

TREATMENT



green pressure-treated

PALMAKO GARDEN FURNITURE SET LEO

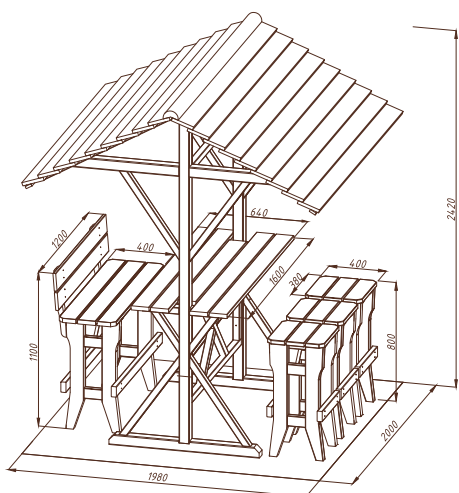

Set consists of: table with roof, bench and three stools.

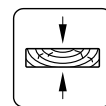

28 mm

TREATMENT



brown pressure-treated

MODEL SPECIFICATIONS

Measurements: 198x200 cm

Height: 242 cm

PALMAKO GARDEN FURNITURE SET ARON

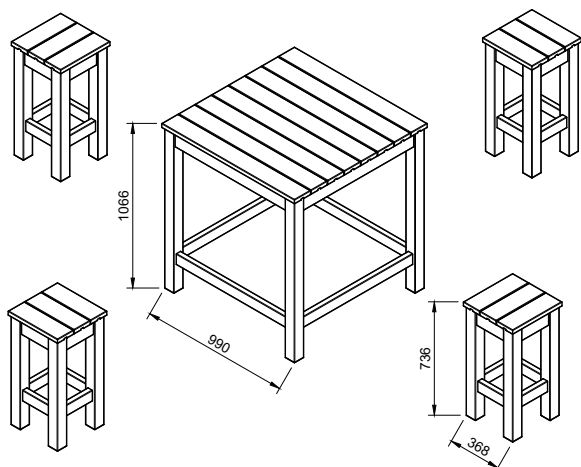

Set consists of table and four stools.

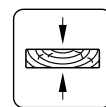

28 mm

TREATMENT



brown pressure-treated

MODEL SPECIFICATIONS

Measurements: 99x99 cm (table),
37x37 cm (stools)

Height: 107 cm (table),
74 cm (stools)



PALMAKO FLOWERBOX MELISSA 4 / 7 / 10



MELISSA 4



MODEL SPECIFICATIONS

Measurements: 34x34 cm

Height: 36 cm

Geotextile included.



Plastic box as optional extra.

MELISSA 7



Measurements: 69x34 cm

Height: 60 cm

Geotextile included.

TREATMENT OPTIONS



brown, pressure treated

MELISSA 10



Measurements: 103x34 cm

Height: 102 cm

Geotextile included.



primer + white painted 2 layers (RAL 9016)

PALMAKO LOG ROLLS



Name	Article number	Diameter (mm)	Height (mm)	Width (mm)	Pcs/pack	Treatment
Log roll ø50 200 2000	102576	50	200	2000	60	green pressure-treated
Log roll ø50 300 2000	102592	50	300	2000	36	green pressure-treated
Log roll ø75 150 1800	102642	75	150	1800	72	green pressure-treated
Log roll ø75 225 1800	102650	75	225	1800	48	green pressure-treated
Log roll ø75 300 1800	102658	75	300	1800	36	green pressure-treated

DESCRIPTION

End processing: Cut at angle and square

Shape: Half round. Fastened with galvanised wire and staples.

PALMAKO HEAT PUMP COVER EDWIN



MODEL SPECIFICATIONS

Measurements,

width x depth: 119x63 cm

Height, front/back: 68/85 cm

Consists of four assembled elements (two sides, front side and roof).



TREATMENT



primer + grey painted 2 layers (RAL7016)

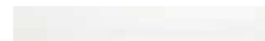

primer+white painted 2 layers (RAL 9016)



Helena 24,6 m²

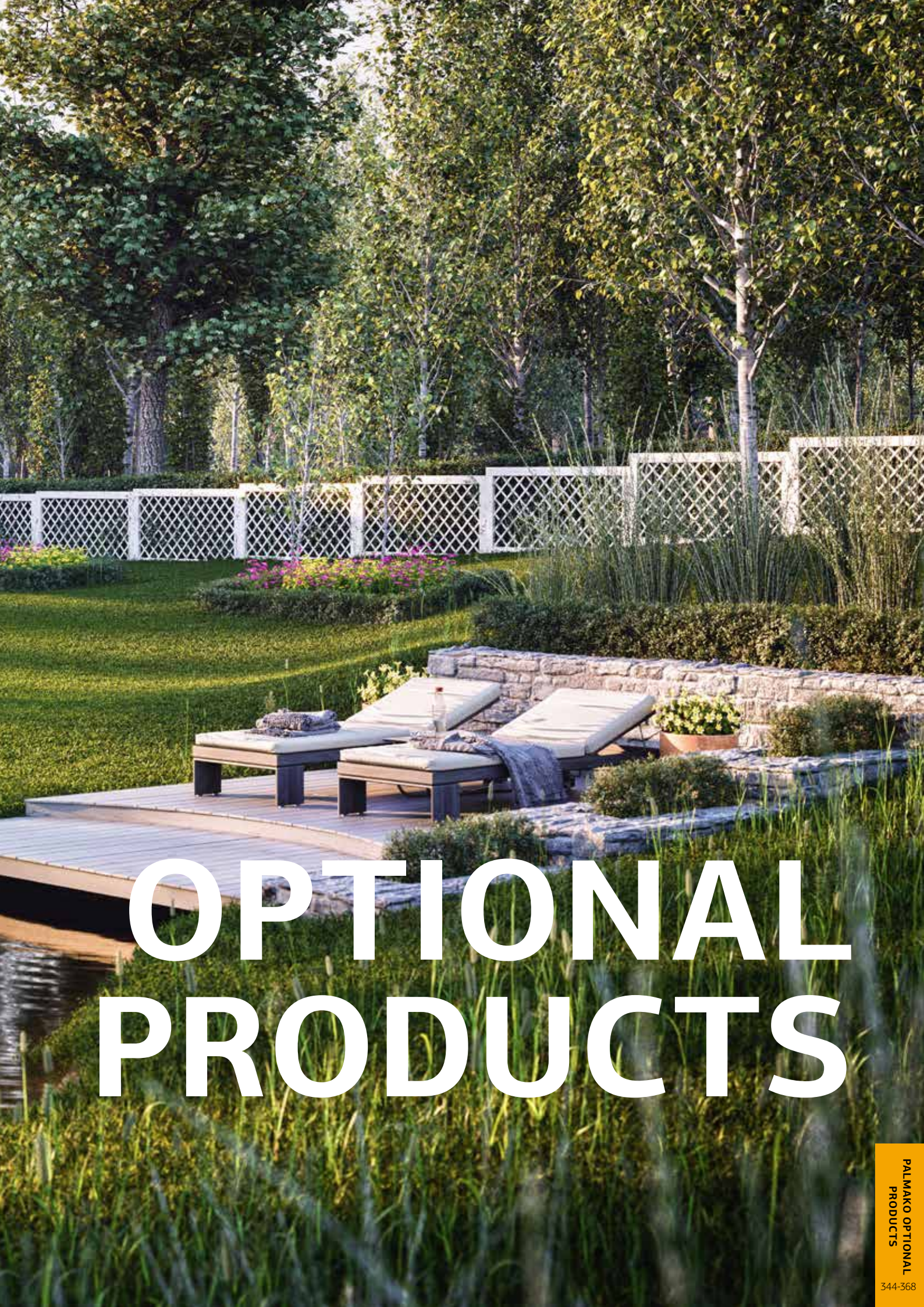

OPTIONAL PRODUCTS

ANCHORS FOR SWINGS AND PLAYGROUNDS



SLIDES FOR PLAYGROUNDS

Art. No.	Platform height	Slide colour
101005	150±5 cm	green
101006	150±5 cm	red
101007	150±5 cm	blue
101004	120±5 cm	red
107382	120±5 cm	blue



SWING SEATS FOR PLAYGROUNDS



EXTENSION 3,1 m²



MODEL SPECIFICATIONS

Log measurements:

163x235 cm

Volume: 5,5 m³

Door/window type: Garden

Door opening

measurements: 73x141 cm

Door sill: low, covered with stainless steel

Roof boards: 19 mm

Roof area: 4,9 m²

Roof gradient: 11,0°

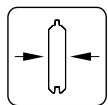
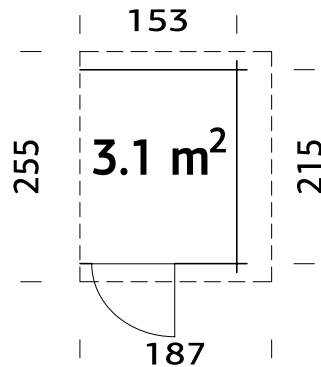

28 mm

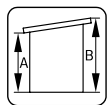

A: 160 cm

B: 183 cm

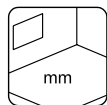

Included

19 mm

OPTIONAL

Roofing felt (underlayer):
1 roll, SBS roofing material:
1 roll, roofing nails, EPDM.

TREATMENT

Available dipped

CANOPY ROOF 4,3 m²



MODEL SPECIFICATIONS

Log measurements:

144x290 cm

Volume: 10,0 m³

Roof boards: 19 mm

Roof area: 4,3 m²

Roof gradient: 16,0°

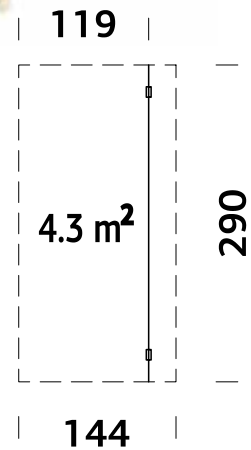

44x95 mm

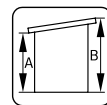

A: 210 cm

B: 250 cm

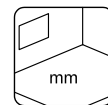

-

OPTIONAL

Roofing felt (underlayer):
1 roll, SBS roofing material:
1 roll, shingles: 2 packs,
roofing nails, EPDM.

TREATMENT

Available dipped

HUUM DROP SAUNA HEATER



NARVI NM SAUNA HEATER



ELEMENT LUCY 12,2 m²



ELEMENT (SOLID)



ELEMENT (GLASS)



MODEL SPECIFICATIONS

Measurements:

103x230 cm

Door/window glass:

Real glass, 4 mm

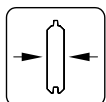

19 mm

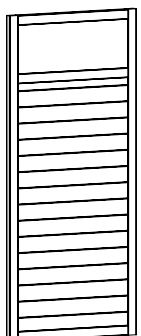

230

103

TREATMENT

- Available dipped
- Available painted

MODEL SPECIFICATIONS

Measurements:

103x230 cm

Door/window glass:

Toughened glass, 6 mm

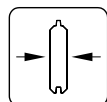

19 mm

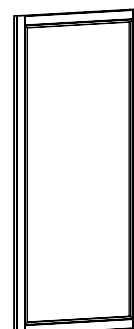

230

103

TREATMENT

- Available dipped
- Available painted

GRILL STOVE WITH TABLE



Grill stove for Eva



Eva 8,7 m²



Eva 11,4 m²

CARPORT ARCH

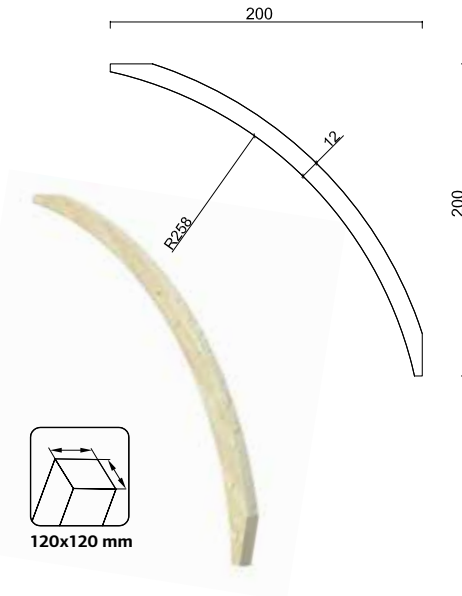

TREATMENT

Available dipped

ANCHOR, ADJUSTABLE POST LEG



PLASTIC POT FOR MELISSA



ENGINE SET FOR GARAGE SECTIONAL DOOR



GARAGE	Engine Set
Roger 19,0 m ² with sectional door	108561
Roger 23,9 m ² with sectional door	108561
Roger 27,7 m ² with sectional door	108561
Roger 21,9+5,2 m ² with sectional door	108561
Roger 28,4 m ² with sectional door	108561
Roger 19,0+16,2 m ² with sectional door	108561
Roger 19,0+16,2 m ² with sectional door	108561
Andre 21,5 m ² with sectional door	108561
Andre 28,5 m ² with sectional door	108561
Andre 44,7 m ² with sectional door	108561

MODEL SPECIFICATIONS

Motor measures: 600x250x350 mm

Rail measures: 3000x50x100 mm

Weight: 10+5 kg

Engine set for garage sectional door includes electrical engine, metal installation construction (rails) and 2 remotes.

Depending on the model of the garage, additional accessories may be required for installation.

Electrical connection required!

ROOFING MATERIAL

To keep your house well protected from the weather, we offer you different types of roof covering materials - roofing felt (suitable as an underlayer), SBS roofing material, shingles or EPDM. The second one, SBS roofing material can be attached in a single layer, but it would be temporary solution and will not last as long as attached in multiple layers. It can be welded on the preplaced bottom layer of roof cladding with a gas burner. Attention! For wooden houses please follow the safety requirements, and if possible please let it be welded by professional roofers. The last, EPDM, is perfect for flat-roof models. We offer shingles in four different colours as follows - black, red, green or brown. You can buy roof covering material in full rolls/packs/ready-cut pieces.

	Article number
Roofing felt, black, 1 roll = 10 m	107210
SBS roofing material black, 1 roll = 10 m	107214
Shingles, black, 1 pack = 3 m ²	107180
Shingles, red, 1 pack = 3 m ²	107182
Shingles, green, 1 pack = 3 m ²	107183
Shingles, brown, 1 pack = 3 m ²	107181
EPDM, black, 1 roll = 1,5x10 m	111847



Black roofing felt (underlayer)



SBS roofing material



Black shingles



Black EPDM

ROOFING NAILS, 1 kg



RAIN GUTTERS

Gutter width 130 mm
Downpipe diameter 80 mm

	Art. No.
3 m set for gable roof	106629
4 m set for gable roof	106630
5 m set for gable roof	106631
6 m set for gable roof	106632
7 m (3+4) set for gable roof	106629 + 106630
10 m (6+4) set for gable roof	106632 + 106630
3 m set for flat roof	106626
4 m set for flat roof	106627
5 m set for flat roof	107375
6 m set for flat roof	106628
7 m (3+4) set for flat roof	106626 + 106627
9 m (6+3) set for flat roof	106628 + 106626



Rain gutters, dark brown only!

ROOF COVERING MATERIAL FOR FLAT ROOF HOUSES

Palmako offers a wide range of flat roof cabins. A question that we have always been asked is what to use as waterproof roof covering material for flat roofs? As you notice in the section of „Optional“ under each flat roof house there is a mention of special rubber roof covering material – EPDM (ethylene propylene diene monomer).

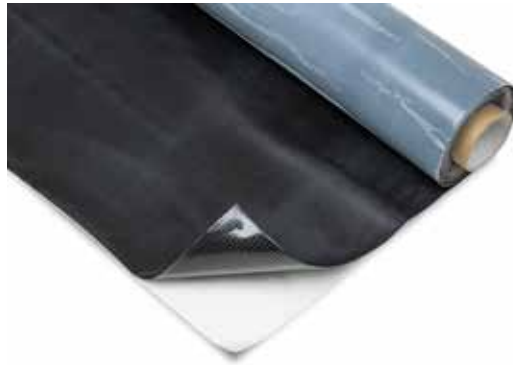

We offer **self-adhesive EPDM** with one fully adhesive side. One roll is 1,5 m wide and 10 m long. The article number and number of rolls suitable for the specific house is given in the table of optional products after every product group and in the Optional Products part at the end of the catalogue.

The outer layer is made of vulcanized EPDM rubber in black colour, suitable for exposure to weather, with 400% elasticity and high impact resistance. The inner layer is fully adhesive due to the addition of a water-based dispersion adhesive, free of solvents and VOCs. This layer is protected by a white release film.

Preparation

- The support must be dry and clean, free of dust.
- There are no sharp elements, such as splinters, nail heads or protruding screws.
- There are no cutting or aggressive edges or joints between boards.

Necessary tools

- White marker
- Scissors (don't use cutter or knives)
- Pressure roller

The installation of EPDM is easy, just follow the installation manual enclosed with the product.

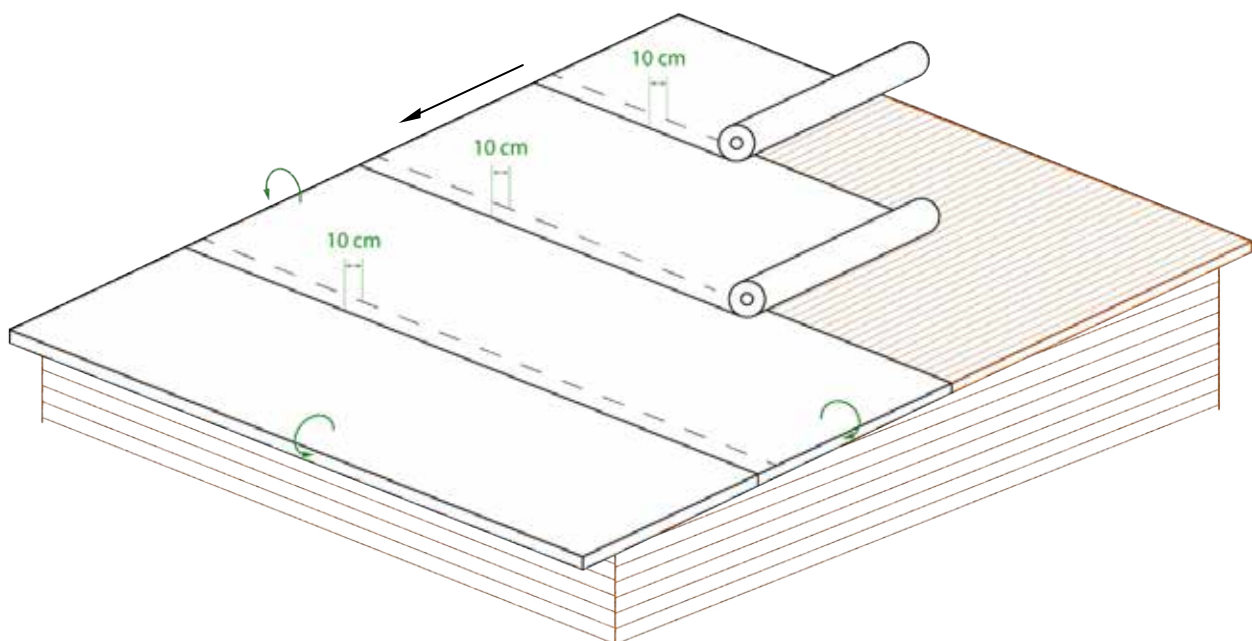

FOUNDATION FRAMES (INCL. LOGFOOT™ BRACKETS)

We offer our garden house customers a Foundation Kit, which includes a cut-to-size foundation frame and adjustable metal feet, known as LogFoot™. The foundation frames are pre-cut to certain fixed sizes. However, to ensure a perfect fit for your specific garden house, some final adjustments are needed to match the frame to the exact dimensions of your cabin.

FOUNDATION FRAME 300X300 CM



TREATMENT



brown dip

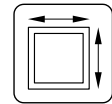

300x300 cm

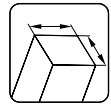

44x120 mm

FOUNDATION FRAME 450X300 CM



TREATMENT



brown dip

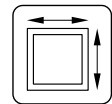

450x300 cm

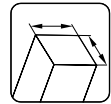

44x120 mm

FOUNDATION FRAME 600X300 CM



TREATMENT



brown dip

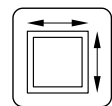

600x300 cm

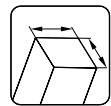

44x120 mm

FOUNDATION FRAME 600X600 CM



TREATMENT



brown dip

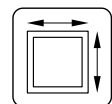

600x600 cm



44x120 mm

FOUNDATION FRAME 450X450 CM



TREATMENT



brown dip

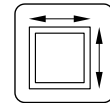

450x450 cm

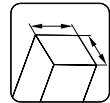

44x120 mm

FOUNDATION FRAME 600X450 CM



TREATMENT



brown dip

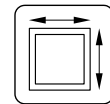

600x450 cm

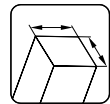

44x120 mm

FOUNDATION FRAME 240X180 CM



TREATMENT



brown dip

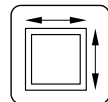

240x180 cm

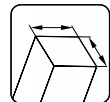

45x70 mm

FOUNDATION FRAME 270X230 CM



TREATMENT



brown dip

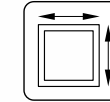

270x230 cm

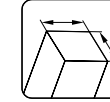

45x70 mm

LogFoot™ brackets – corner bracket and frame bracket



Scan this QR-code to see the assembly of a foundation frame!

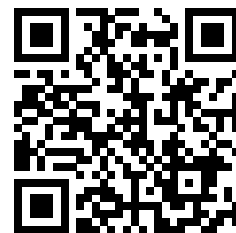

FLOORS

To meet specific market demands some of our cabins are sold without a floor. Although in majority cases floor can be purchased as an optional extra. As of 2021 Palmako starts to offer unified floor kits in such cases.

An unified floor kit contains of:

- 19x89x2350 mm double and tenoned needed number of floorboards
- 45x70x3000 mm brown dipped (BNDIP) needed number of foundation beams
- 19x19x2350 mm skirting boards
- 19x19 mm door strip according to the width of the door opening (in two sizes - for a single door and a double door) and the wall thickness.

Unified floor kits can be brown, grey or white dipped.

Due to the different size of cabins and measurements of the floors, please consider below described principle in general in cutting floorboards into the exact measure.

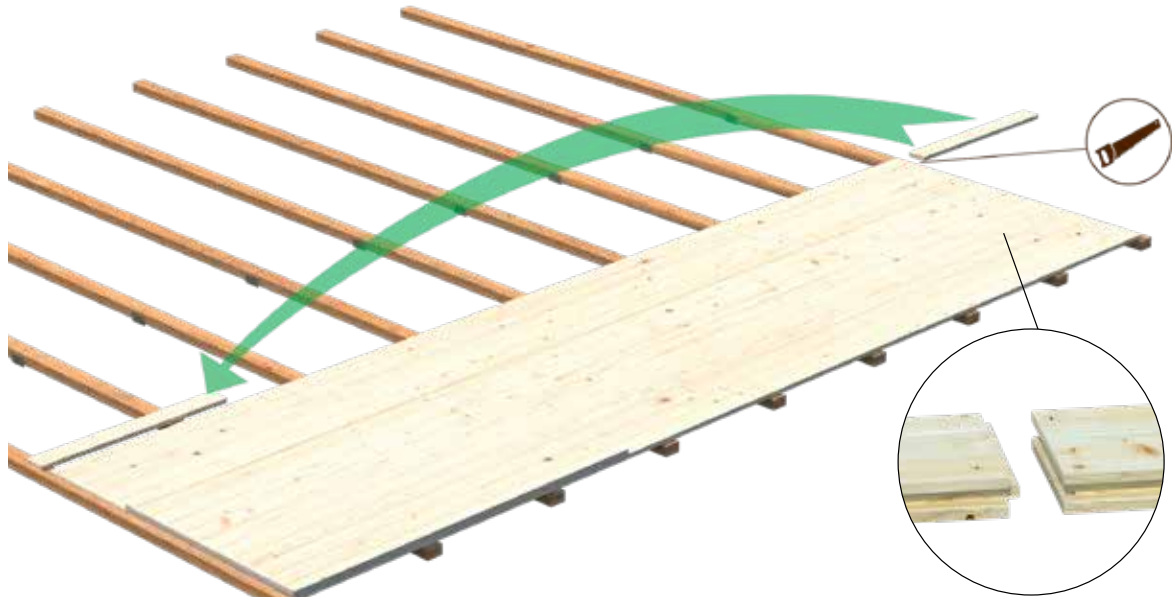

Double end tenoned floor board



Brown dipped foundation beams, 45x70 mm

House	Art. No.	Floor boards	Additional info
Lotta 7,3 m ²	102971	19 mm	
Lotta 10,0 m ²	102986	19 mm	
Lotta 13,9 m ²	103030	19 mm	
Klara 4,7 m ²	102975	19 mm	
Klara 10,4 m ²	103011	19 mm	
Klara 17,0 m ² *	103062	19 mm	FSC
Valentine 4,7 m ² *	109456	19 mm	FSC, pressure-treated
Valentine 6,1 m ² *	109522	19 mm	FSC, pressure-treated
Valentine 9,0 m ² *	109518	19 mm	FSC, pressure-treated
Valentine 11,0 m ² *	109520	19 mm	FSC, pressure-treated
Britta 14,6 m ²	103038	19 mm	FSC
Britta 17,5 m ²	103050	19 mm	FSC
Britta 19,7 m ²	103066	19 mm	FSC
Britta 22,3 m ²	103070	19 mm	FSC
Ella 6,9 m ² / Ella 6,9+8,2 m ² / Ella 6,9+10,0 m ²	102967	19 mm	
Ella 8,7 m ² / Ella 8,7+8,2 m ² / Ella 8,7+10,0 m ²	102994	19 mm	
Ella 13,1 m ² / Ella 13,1+3,9 m ²	108279	19 mm	

As some of our floors as an optional extra are very specific, cut into angle (Betty pergolas), then product specific floor kits are still available as follows:



House	Art. No.	Floor boards	Additional info
Betty 9,0 m ² / Bianca 8,3 m ²	103090	28 mm	FSC, pressure-treated
Betty 9,9 m ²	103092	28 mm	FSC, pressure-treated
Betty 18,0 m ²	103094	28 mm	FSC, pressure-treated
Betty 25,0 m ²	103096	28 mm	FSC, pressure-treated
Stella 5,0 m ²	102883	16 mm	
Stella 8,2 m ²	102924	16 mm	

*Klara 17,0 m²
 *Valentine 4,7 m²
 *Valentine 6,1 m²
 *Valentine 9,0 m²
 *Valentine 11,0 m²



PALMAKO POLE BASE AND FENCE PANEL FASTENERS



**Post leg with pile
90x90 mm hot dip**
Art. No.: 106617



**Post leg with pile
70x70 mm hot dip**
Art. No.: 107487



**Post leg rectangular plate
90x90 mm hot dip**
Art. No.: 106613



**Post leg side support
70x70 mm hot dip**
Art. No.: 107492



**Post leg side support
70x70 mm white**
Art. No.: 107493



**Post leg side support
90x90 mm hot dip**
Art. No.: 107494



**Post leg side support
90x90 mm white**
Art. No.: 107495



**Post leg corner
hot dip**
Art. No.: 107489



**Post leg corner
white**
Art. No.: 107488

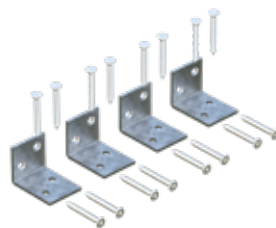

**L-type fastening brackets
(set 4 pcs) hot dip**
Art. No.: 108424

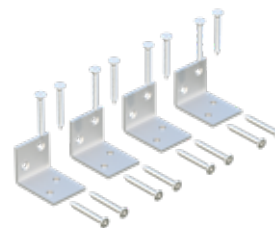

**L-type fastening brackets
(set 4 pcs) white**
Art. No.: 108423



**Wooden screws
(set 8 pcs) hot dip**
Art. No.: 120373



**Wooden screws
(set 8 pcs) white**
Art. No.: 107486



**Fence gate
hardware kit**
Art. No.: 108303



**Post cap
70x70 mm white**
Art. No.: 108300



**Post cap
90x90 mm white**
Art. No.: 108302

ADDITIONAL DOORS AND WINDOWS

Majority of our cabins and buildings are designed in a way, that one can easily amend it with additional door(s) and window(s) in addition to the existing ones. So far Palmako offered a limited range of additional doors and windows. As of 2021 we offer full range of doors and windows suitable to our buildings. For example our cozy and classical cabin Sally 15,5 m² has just one double window in original set. If one wishes a more lightful cabin, it can be easily amended by exactly the same type of additional window (Art. No. 103502). As one building can consist of different sizes and models of doors and windows, please consult with our sales team before placing an order.

- 1 Cabin Sally 15,5 m² with one double window in original set
- 2 Cutting the wall according to the measures of the window
- 3 Cabin Sally 15,5 m² has now two double windows



GABLE ROOF CABINS

Product Art. No.	Product name	Wall thickness, (mm)	Door/Window type	Article number*	
				Additional door(s)	Additional window(s)
101314	Vivian 3,8 m ²	28	Garden	103604	
101523	Vivian 6,9 m ²	28	Garden	103534	
101482	Lotta 7,3 m ²	28	Garden	103534	
101646	Lotta 10,0 m ²	34	Garden	106860	
101694	Lotta 13,9 m ²	34	Garden	106860	
101827	Klara 4,7 m ²	28	Garden	107035	100038
101990	Klara 10,4 m ²	28	Garden	106829	100038
102130	Klara 17,0 m ²	28	Garden	106829	100038, 100036
109452	Valentine 4,7 m ²	28	Garden	109541	
109454	Valentine 6,1 m ²	28	Garden	109541	
109458	Valentine 9,0 m ²	28	Garden	109541	
109527	Valentine 11,0 m ²	28	Garden	109541	109551
102072	Britta 14,6 m ²	40	Garden	106864	100082
102252	Britta 17,5 m ²	40	Garden	106864	103494
102262	Britta 19,7 m ²	40	Garden	106864	103494
102266	Britta 22,3 m ²	40	Garden	106864	103494
101797	Emma 4,6 m ²	28	Garden	103604	103320
102033	Emma 10,4 m ²	34	Garden	103551	103348
101885	Emma 10,4+4,2 m ²	34	Garden	109098	103348
102339	Emma 14,2 m ²	34	Garden	107046, 103551	103490
102270	Sally 10,2 m ²	44	Summer	106880	111769
102083	Sally 12,3 m ²	44	Summer	106880	120333
102274	Sally 15,5 m ²	44	Summer	106880	111769
102312	Sally 19,1 m ²	44	Summer	106880	111769
102318	Helena 15,1 m ²	70	Summer	112112	112108
102511	Helena 18,6 m ²	70	Summer	112112	112104, 112100, 112108
102515	Helena 24,6 m ²	70	Summer	112112	112104, 112100, 112108
102465	Susanna 12,4 m ²	44	Summer	106880	120333, 111750
102469	Susanna 16,4 m ²	44	Summer	106880	120333, 111750
102351	Irene 19,0 m ²	44	Garden+	107060, 103559	106690
102367	Irene 23,9 m ²	44	Garden+	107060, 103559	106690
102490	Irene 21,9+5,2 m ²	44	Garden+	107060, 103559	100095
102375	Irene 27,7 m ²	70	Summer	107105, 103591	106715
120066	Irene 19,0+16,2 m ²	44	Garden+	103559, 107060	106690
120070	Irene 19,0+33,2 m ²	44	Garden+	103559, 107060	106690
101978	Iris 9,6 m ²	28	Garden	103530	100028
102185	Iris 11,1 m ²	44	Garden+	111393	111385, 111389
102214	Iris 19,1 m ²	44	Garden+	111393	111385, 111389
119361	Claudia 14,2 m ²	44	Summer	111393	120017, 120021
102519	Claudia 11,5 m ²	34	Garden	103543	106668
102387	Claudia 19,4 m ²	44	Garden+	111393	111385, 111389
119350	Claudia Pent 11,5 m ²	34	Summer	120303	120307
119337	Claudia Pent 19,4 m ²	44	Summer	111393	111385, 111389
101724	Ines 11,1 m ²	44	Garden+	108554	
101732	Ines 13,7 m ²	44	Garden+	108554	

* Article number is given as natural wood (NO treatment). If the house has treatment options, one also can order additional door(s) and window(s) with the same treatment. Just consult with our sales team or representative.

FLAT ROOF CABINS

Product Art. No.	Product name	Wall thickness, (mm)	Door/Window type	Additional door(s)	Article number*	
					Additional door(s)	Additional window(s)
111242	Alice 4,7 m ²	28	Garden	109541		
111244	Alice 6,1 m ²	28	Garden	109541		
111246	Alice 9,0 m ²	28	Garden	109541		
111248	Alice 11,0 m ²	28	Garden	109541		109551
101453	Ella 6,9 m ²	28	Garden	103530		
101543	Ella 8,7 m ²	28	Garden	103530		
101595	Ella 6,9+8,2 m ²	28	Garden	103530		
101607	Ella 6,9+10,0 m ²	28	Garden	103530		
101611	Ella 8,7+8,2 m ²	28	Garden	103530		
101623	Ella 8,7+10,0 m ²	28	Garden	103530		
108218	Ella 13,1 m ²	28	Garden	109097, 103530		
108222	Ella 13,1+3,9 m ²	28	Garden	109097, 103530		
102281	Lisa 11,5 m ²	34	Garden	103543		106668
102197	Lisa 14,2 m ²	44	Garden+	111393		111385, 111389
101749	Lisa 19,4 m ²	44	Garden+	111393		111385, 111389
101728	Lea 14,2 m ²	44	Garden+	108554		
101736	Lea 19,4 m ²	44	Garden+	108554		
109159	Bret 14,8 m ²	44	Garden+	120341		119404, 119408
109163	Bret 19,9 m ²	44	Garden+	120341		119404, 119408
106355	Heidi 11,7 m ²	44	Summer	120341		111742
106370	Heidi 19,7 m ²	70	Summer	119204		112242, 119196
110077	Heidi 22,5 m ²	70	Summer	119200, 119204		112242, 119196
106381	Heidi 22,8 m ²	70	Summer	119200, 119204		112242, 120345

COTTAGES

Product Art. No.	Product name	Wall thickness, (mm)	Door/Window type	Additional door(s)	Article number*	
					Additional door(s)	Additional window(s)
109494	Kendra 18,4 m ²	70	Summer	107101, 111398		112104, 120349, 112108
106569	Emily 39,2 m ²	70	Summer	119183, 107154, 107153		112104, 112100, 120349, 112108
106566	Emily 40,1+5,2 m ²	70	Summer	119183, 107154		112104, 120349, 112108
106522	Agneta 18,8+12,5 m ²	70	Summer	112147		112143
106526	Agneta 18,8+28,8 m ²	70	Summer	112147		112143
106568	Anna 26,8 m ²	70	Summer	107101, 112247		120369, 120349, 111397
106399	Anna 26,8+1,9 m ²	70	Summer	107107, 106960		106717
106567	Sandra 21,5+3,7 m ²	70	Summer	107156, 107154, 107153		100178, 103364
106210	Sandra 25,6+11,1 m ²	44	Summer	107064, 112191, 107055, 107054		112195, 112199
106214	Sandra 29,9 m ²	44	Summer	112203, 112179		112187, 112183, 112195, 120353
120010	Cecilia 14,2 m ² Slide Plus	70	Summer	120468, 107154		120471
120009	Cecilia 21,8 m ² Slide Plus	70	Summer	120468, 107154		120471
120008	Cecilia 27,2 m ² Slide Plus	70	Summer	120468, 107153		120471, 120470
120007	Cecilia 30,0 m ² Slide Plus	70	Summer	120468, 107154, 107153		120471, 120470
120006	Cecilia 32,0 m ² Slide Plus	70	Summer	120468, 107154		120471, 120470, 120469

MODERN LOOK HOUSES

Product Art. No.	Product name	Wall thickness, (mm)	Door/Window type	Additional door(s)	Article number*	
					Additional door(s)	Additional window(s)
108586	Grace 8,1m ² +4,1m ²	56	Living	109095		109086
108587	Grace 8,1m ² +8,1m ²	56	Living	109095		109086
108588	Grace 12,4m ² +4,1m ²	56	Living	109095, 109099		109086
108922	Grace 14,5 m ²	56	Living	109544		109086

NORDIC & NORDIC+ HOUSES

Product Art. No.	Product name	Wall thickness, (mm)	Door/Window type	Additional door(s)	Article number*	
					Additional door(s)	Additional window(s)
101147	Ly 13,6 m ²	18+70	Summer	107325		103309
101163	Hedwig 13,6 m ²	18+70	Summer	109058		120489
101151	Etta 13,6 m ²	18+70	Summer	107325		120329
109000	Simone 13,6 m ²	18+70	Summer	106793		107289
109044	Annabel 13,4 m ² kit	18+70	Summer			109172
108994	Annabel 13,4 m ² Slide	18+70	Summer	109176		109172
101253	Charlotte 21,5 m ²	160	Summer	107325		107289, 107297
101261	Pernilla 21,5 m ²	160	Summer	107329		107293, 107297
101257	Annika 21,5 m ²	160	Summer	107325		107289

PAVILIONS

Product Art. No.	Product name	Wall thickness, (mm)	Door/Window type	Additional door(s)	Article number*	
					Additional door(s)	Additional window(s)
103712	Melanie Low 7,0 m ²	28	Garden	109547		109548
103708	Melanie 7,0 m ²	28	Garden	109547		109548
103728	Melanie 6,9 m ²	44	Garden+	109546		109545
103732	Melanie 9,9 m ²	44	Garden+	109546		109545
103778	Melanie 7,0+8,1 m ²	28	Garden	109547		109548
103724	Hanna 7,6 m ²	34	Garden	109549		109550
106185	Hanna 14,1 m ²	44	Garden+	109569		109545
106189	Hanna 20,3 m ²	44	Garden+	109168		109545
103744	Veronica 2 6,7 m ²	28	Garden+	106826		106660
103748	Veronica 4 6,7 m ²	28	Garden+	106826		106660
103734	Veronica 4 9,2 m ²	34	Garden+	106845		103485
103733	Veronica 7 9,2 m ²	34	Garden+	106845		103485
119341	Isabella 10,9 m ²	90x90	Alu SG	111393		120300, 120301, 120279 120300, 120301, 120279,
112126	Isabella 14,7 m ²	90x90	Alu SG	111393		120289, 120299 120300, 120301, 120279,
119345	Isabella 22,2 m ²	90x90	Alu SG	111393		120289, 120299
104592	Eva 8,7 m ²	44	Garden+	107092		100100
104596	Eva 11,4 m ²	44	Garden+	107092		100100

* Article number is given as natural wood (NO treatment). If the house has treatment options, one also can order additional door(s) and window(s) with the same treatment. Just consult with our sales team or representative.

GARDEN SPA

Product Art. No.	Product name	Wall thickness, (mm)	Door/Window type	Article number*	
				Additional door(s)	Additional window(s)
110343	Anita 0,9 m ²	42	Summer	110120	
110070	Anita 1,3+0,7 m ²	42	Summer	110120	
111005	Anita 1,3+0,7 m ² with glass wall	42	Summer	110120	
111003	Anita 1,6+0,7 m ²	42	Summer	110120	
111004	Anita 1,6+0,7 m ² with glass wall	42	Summer	110120	
110071	Anette 3,0+1,5 m ²	42	Garden+	110120, 110121	110122
110741	Sanna 4,1 m ²	44	Summer	111740	111738
110526	Sanna 6,8 m ²	44	Summer	111740, 111741	111738, 111739
111001	Sanna 4,1+5,9 m ²	44	Summer	111740	111738
111002	Sanna 6,8+5,9 m ²	44	Summer	111740, 111741	111738, 111739
119349	Sanna 11,5 m ²	44	Summer	120341, 111741	111738
111000 / 111239	Sanna 12,8 m ² Slide/Slide Plus	44		111741	111738
119360	Grace Sauna 5,3 m ²	56	Alu DG	120467	120473
112125	Grace Sauna 8,2 m ²	56	Alu DG	120467, 120477	120473, 120472
120033	Sarah 3,8+2,1 m ²	120x120	Summer	111740	120474

GARAGES

Product Art. No.	Product name	Wall thickness, (mm)	Door/Window type	Article number*	
				Additional door(s)	Additional window(s)
101894	Rasmus 19,0 m ² kit	44	Garden	107053, 103555, 103516	100094
102415	Rasmus 19,0 m ² with wooden gate	44	Garden	107053, 103555	100094
102419	Rasmus 19,0 m ² with sectional door	44	Garden	107053, 103516	100094
101899	Roger 19,0 m ² kit	44	Garden+	107060, 103555, 103516	106690
102347	Roger 19,0 m ² with wooden gate	44	Garden+	107060, 103555	106690
102355	Roger 19,0 m ² with sectional door	44	Garden+	107060, 103516	106690
101903	Roger 23,9 m ² kit	44	Garden+	107060, 103555, 103516	106690
102498	Roger 23,9 m ² with wooden gate	44	Garden+	107060, 103555	106690
102502	Roger 23,9 m ² with sectional door	44	Garden+	107060, 103516	106690
101911	Roger 27,7 m ² kit	70	Summer	120337, 103587, 103516	112108
102379	Roger 27,7 m ² with wooden gate	70	Summer	120337, 103587	112108
102383	Roger 27,7 m ² with sectional door	70	Summer	120337, 103516	112108
101872	Roger 21,9+5,2 m ² kit	44	Garden+	107060, 103555, 103516	100095
102482	Roger 21,9+5,2 m ² with wooden gate	44	Garden+	107060, 103555	100095
102486	Roger 21,9+5,2 m ² with sectional door	44	Garden+	107060, 103516	100095
101907	Roger 28,4 m ² kit	44	Garden+	107060, 103555, 103516	106690
102399	Roger 28,4 m ² with wooden gate	44	Garden+	107060, 103555	106690
102403	Roger 28,4 m ² with sectional door	44	Garden+	107060, 103516	106690
120074	Roger 19,0+16,2 m ² kit	44	Garden+	103559, 103555, 103516	106690
120078	Roger 19,0+16,2 m ² with wooden gate	44	Garden+	103559, 103555	106690
120082	Roger 19,0+16,2 m ² with sectional door	44	Garden+	103559, 103516	106690
120086	Roger 19,0+33,2 m ² kit	44	Garden+	103559, 103555, 103516	106690
120090	Roger 19,0+33,2 m ² with wooden gate	44	Garden+	103559, 103555	106690
120094	Roger 19,0+33,2 m ² with sectional door	44	Garden+	103559, 103516	106690
108613	Andre 21,5 m ² kit	160	Summer	107329, 103516	120259
101159	Andre 21,5 m ² with sectional door	160	Summer	107329, 103516	120259
108614	Andre 28,5 m ² kit	160	Summer	107329, 103516	120259
101167	Andre 28,5 m ² with sectional door	160	Summer	107329, 103516	120259
108615	Andre 44,7 m ² kit	160	Summer	107329, 103516	120259
108616	Andre 44,7 m ² with sectional door	160	Summer	107329, 103516	120259

The colour code of the sectional door: RAL 9016

Art. No. 103516



SHEDS

Product Art. No.	Product name	Wall thickness, (mm)	Door/Window type	Article number*	
				Additional door(s)	Additional window(s)
101076	Mia 3,6 m ²	16+32	Shed		
101184	Mia 5,4 m ²	16+32	Shed		
101080	Leif 2,2 m ²	16+32	Shed		
101071	Leif 3,0 m ²	16+32	Shed		
101081	Leif 4,5 m ²	16+32	Shed		
110981	Leif 3,0+2,9 m ²	16+32	Shed		
111018	Leif 4,5+2,9 m ²	16+32	Shed		
101176	Dan 4,5 m ²	16+32	Shed		
101198	Dan 7,5 m ²	16+32	Shed		
101206	Dan 9,9 m ²	16+32	Shed		
101210	Dan 14,7 m ²	16+32	Shed		
101180	Nils 5,4 m ²	16+32	Shed		
101188	Nils 8,2 m ²	16+32	Shed		
108617	Lucas 5,4 m ²	16+32	Summer	109101	
108618	Lucas 12,1 m ²	16+32	Summer	109094	
107218	Marcus 6,5 m ²	16+32	Shed		
110073	Stig 8,2 m ²	16+32	Summer	109093	
101324	Jari 8,9 m ²	28	Shed		
101338	Jari 14,5 m ²	28	Shed		
101086	Martin 8,4 m ²	18+70	Summer	109093	
101045	Martin 13,6 m ²	18+70	Summer	109093	
101229	Olaf 6,6 m ²	18+70	Summer	109100, 109093	111737
101231	Olaf 13,5 m ²	18+70	Summer	109100, 109093	111737
101236	Olaf 16,9 m ²	18+70	Summer	109100, 109093	111737
101228	Kalle 6,6 m ²	18+70	Summer	109100, 109093	111737
101232	Kalle 13,5 m ²	18+70	Summer	109100, 109093	111737
101056	Kalle 16,9 m ²	18+70	Summer	109100, 109093	111737
109668	Kira 7,7 m ²	16+32	Summer	109100	
101137	Stella 5,0 m ²	16+32	Shed		
101141	Stella 8,2 m ²	16+32	Shed		

* Article number is given as natural wood (NO treatment). If the house has treatment options, one also can order additional door(s) and window(s) with the same treatment. Just consult with our sales team or representative.

With standard doors Palmako provides door handle and lock cover kit. Shall one need to change the existing door handle and lock cover kit or just needs one extra, we are more than glad to deliver.

Art. No. 108422



PLYWOOD DOORS

If you have built a garden house, shed or have in your garden some other ancillary building that needs a good and proper door in front of it then please get familiar with doors on this page. We have added to our windows and doors selection single and double doors made of plywood. With or without glass, just as you like the best.

MODEL SPECIFICATIONS

Jamb: pine
 Laminated finger jointed frame
 Red wood plywood 4 mm
 Cladding 12x114 mm

Rubber seals
 Hardwood threshold
 Hinges (3x)

Art. No.

108304
 Cylinder lock, handle and lock cover for plywood doors are an optional extra!



Art. No.		Door opening measurements, cm	Door opening measurements with jamb, cm
107022	Single door, without glass, left handed	78x191	90x200
107434	Single door, without glass, left handed	78x201	90x210

Art. No.		Door opening measurements, cm	Door opening measurements with jamb, cm
107023	Single door, without glass, right handed	78x191	90x200
107433	Single door, without glass, right handed	78x201	90x210

Art. No.		Door opening measurements, cm	Door opening measurements with jamb, cm
107024	Single door, with glass, left handed	78x191	90x200
108280	Single door, with glass, left handed	78x201	90x210

Art. No.		Door opening measurements, cm	Door opening measurements with jamb, cm
107329	Single door, with glass, right handed	78x191	90x200
108281	Single door, with glass, right handed	78x201	90x210

Art. No.		Door opening measurements, cm	Door opening measurements with jamb, cm
103526	Double door, without glass, right handed	118x191	130x200
103527	Double door, without glass, right handed	138x191	150x200

Art. No.		Door opening measurements, cm	Door opening measurements with jamb, cm
103528	Double door, with glass, right handed	118x191	130x200

Art. No.		Door opening measurements, cm	Door opening measurements with jamb, cm
103529	Double door, with glass, right handed	138x191	150x200



GLAZED SLIDING DOORS

From now on we have many houses with sliding doors in our product range. Sliding doors have many benefits which may encourage you to favor them over the regular doors. They let in more natural light, large glass panels running from the ground up to the top maximizes the natural lighting in the room. Sliding doors are useful if there is a need for ventilating the room without opening any door too wide. They are easy to use when entering and leaving the house. The large glass surfaces of the sliding doors let you enjoy beautiful views to the garden or backyard. And last, but not least, sliding doors look good, they add aesthetics to the building and are valued for functional and practical design. Sliding doors are just beautiful!

Sliding door Slide

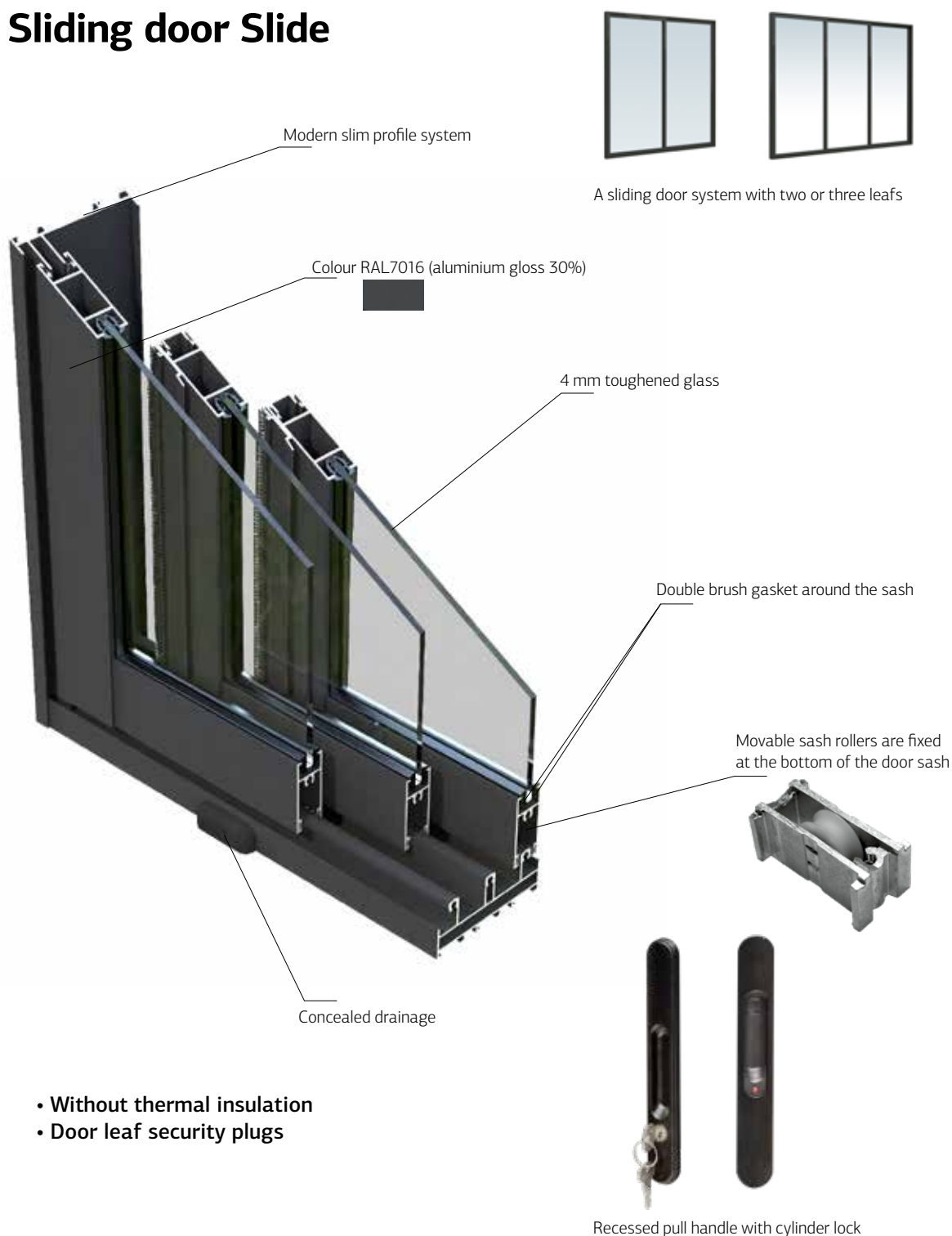

- Without thermal insulation
- Door leaf security plugs

Sliding door Slide Plus



A sliding door system with two or three leaves

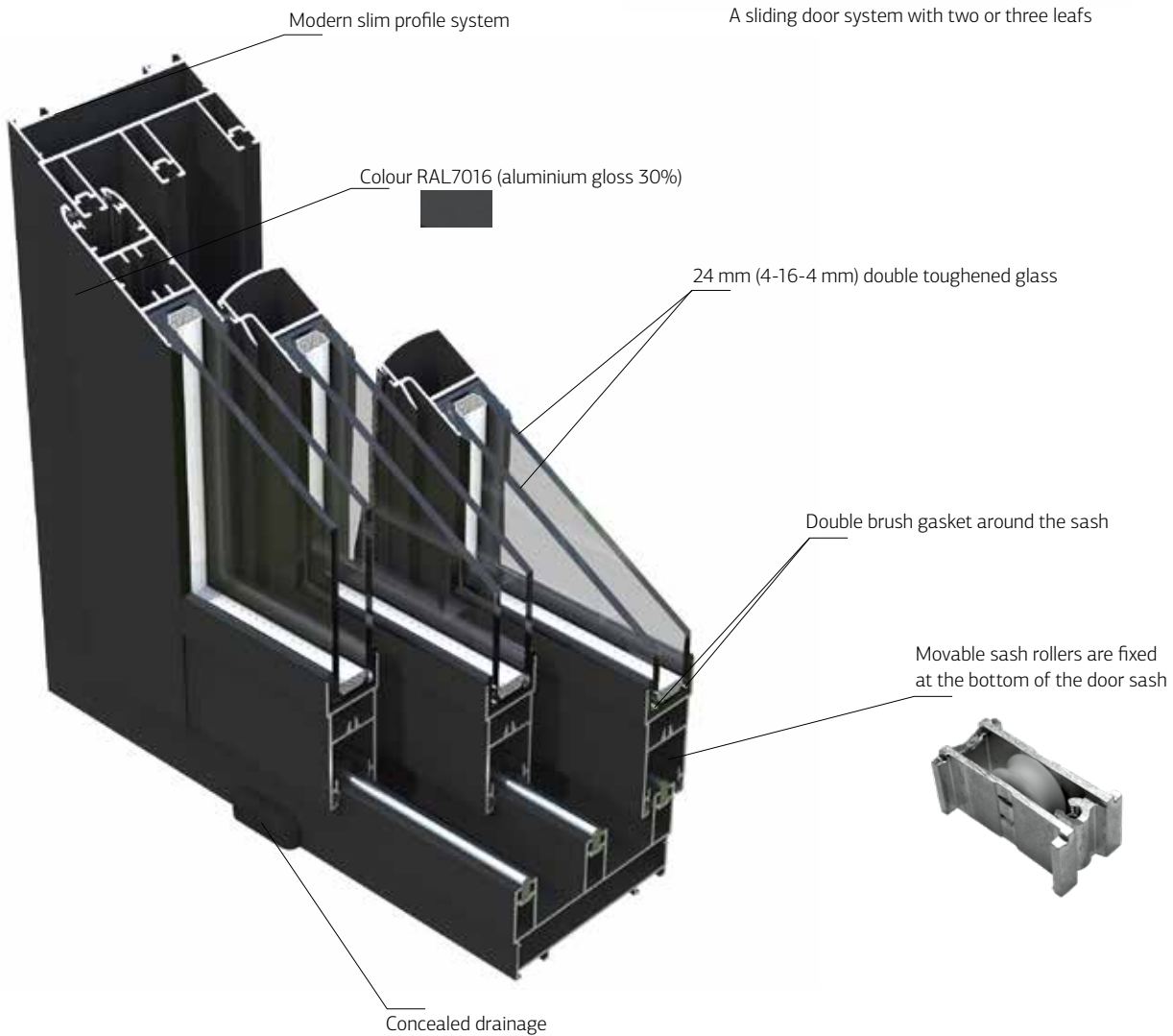

- Door leaf security plugs



Surface mounted pull handle with cylinder lock

Treatment as additional protection for wooden products

Production lines and machines allow us to flexibly arrange procedures and to produce a very wide product range from square log houses with different log thicknesses to the element, prefabricated and large weekend log houses. In addition to other wooden products in your garden - fence panels, terrace fences, garden furniture, machine rounded posts, flowerboxes, log rolls and many other products.

Unprocessed wood becomes greyish after having been left untouched for a while and can turn blue and become moldy. Treating wood with a preservative effectively protects against wood-destroying fungi and insects, including termites. Therefore we recommend using our product treatment service. Depending on the product type we are able to treat the products in different ways.

DIPPING

As we have our own treatment baths for brown, grey and clear white dip treatment, cabins and other larger sized items can be ordered treated with Axil 3000 P by the Sarpap & Cecil Industries water-soluble treatment liquid, guaranteeing treatment within classes 1–3. Dipped wood must be finished with at least two layers of topcoat. Topcoat should be applied on the dipped product as soon as possible. In case the dipped cabin is left unfinished for over six months, the wood protective properties of the dipping liquid will start decreasing.



Dipping bath for treatment



WTDIP white dip



BNDIP brown dip



GYDIP grey dip



Pressure-treated wooden details in a wood treatment autoclave

PRESSURE-TREATING

Smaller sized items like furniture can be pressure-treated in the vacuum-pressure-vacuum method giving these items a green or brown shade. Depending on model, fence panels can be grey or green pressure-treated or white or grey painted (primer plus two layers of paint). In order to extend the service life of timber we treat our products with Impralit®-KDS wood preservative. This is a water-borne, chromium-free wood preservative for the prevention of insect attacks, soft rot and fungal decay. It also offers temporary protection against blue stain and mould. Impralit®-KDS is only to be used for treating wood according to the

requirements of use classes 1, 2, 3 and 4 as stipulated in EN 335-1. For wood under cover and in the open, above ground and in ground contact, e.g. poles, fencing, playgrounds, pergolas, etc. The preservative penetrates deep into the wood with the help of vacuum and pressure. In this case a vacuum is initially generated in the cell cavities thereby evacuating the air inside them. The cavities are then filled with a preservative solution that is forced into the wood under high pressure. For vacuum pressure impregnation we work with different processes depending on the type of wood, environment and end purpose.



GYVPI grey pressure-treated



GNVPI green pressure-treated



BNVPI brown pressure-treated



BNVPI brown pressure-treated

PAINTING

We have invested into modern painting technology that enables us to paint smaller sized garden products like fence panels and posts. Today we are able to paint the products white or dark grey, using flowcoating method and spray chamber method. After painting, the products will dry in a 30 meter long drying chamber, where the whole process of drying can be adjusted and observed.



WTPNT1+2 primer + white painted 2 layers (RAL 9016)



WTPNT1+2 primer + white painted 2 layers (RAL 9016)



WTPNT1+2 primer + white painted 2 layers (RAL 9016)



GYPNT1+2 primer + grey painted 2 layers (RAL 7016)

PRIMING

Using the same technique, we are now also able to coat several houses with one layer of white primer (WTPNT1+0), which simplifies further finishing of the product.



WTPNT1+0 white primer



WTPNT1+0 white primer



WTPNT1+0 white primer



WTPNT1+0 white primer

Painting the cabins - the highest level of protection for your garden house

We have a new possibility for treating our products – depending on the product we can now paint a wide range of cabins in our product range. We value your time, you don't need to think about or paint the product yourself. After assembling the house all you need to do is furnish the building and enjoy it!

Colours

Let us introduce you to our colour tone system. The combination of colours consist of the main colour and accent colour. Not all the cabins can be painted in all colour combinations, depending on a product every cabin has particular colour combinations to choose from.

An overview of all colour combinations – on the left the main colour, on the right the accent colour:



light grey + anthracite
RAL7042 + RAL7016



dark grey + anthracite
RAL7012 + RAL7016



white + anthracite
RAL9016 + RAL7016



light grey + white
RAL7042 + RAL9016



dark grey + white
RAL7012 + RAL9016

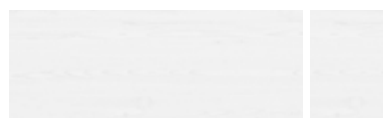

white + white
RAL9016 + RAL9016



light grey + light grey
RAL7042 + RAL7042



dark grey + dark grey
RAL7012 + RAL7012

Paint description

We use weatherproof water-based acrylic paint for finishing wood surfaces and details. The paint forms an elastic, water and dirt repellent protective film on the surface.

No reverse installation

A wide range of our houses can be built in reverse. The wall details of painted cabins are painted only from one side, this is the reason why the painted cabin cannot be installed in reverse.

Natural interior

The interior of the cabin stays natural (interior walls, floor boards and roof boards). You have a choice to cover the interior with a colourless wood impregnation agent and enjoy the beauty of natural wood or use paint, glaze or other wood protection.

Pictures are illustrative only

Please note that the visuals of the painted cabins are illustrative only and may differ from the actual finish of the product.

Sales and Warranty Terms and Conditions of painting

Please ask for the sales and warranty terms and conditions of painting from our sales team.



Lea 14,2 m² Slide – main colour RAL7042, accent colour RAL7016

THE DESCRIPTION OF PAINTING THE CABINS

Cabins with modern corner connection

PAINTED

- logs from outside
- doors and windows (painted from outside and inside)
- external slats from all sides

NOT PAINTED

- logs from inside
- floor boards
- roof boards
- rafters, purlins
- all the details seen inside of the house
- foundation beams (brown dipped)



Cabins with chalet-cut logs

PAINTED

- logs from outside
- log ends from outside and inside
- doors and windows (painted from outside and inside)
- external slats from all sides

NOT PAINTED

- logs from inside
- floor boards
- roof boards
- rafters, purlins
- all the details seen inside of the house
- foundation beams (brown dipped)



Canopy roofs

PAINTED

- back wall (painted from both sides)
- external slats from all sides
- posts
- front rafter and back rafter
- Louvre wall

NOT PAINTED

- roof boards
- rafters, purlins in the middle



Post and beam construction, windows and doors

PAINTED

- all the wooden details from all sides

NOT PAINTED

- foundation beams (brown dipped)



Element houses

PAINTED













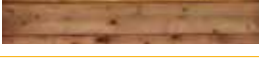

- elements from outside
- doors and windows (painted from outside and inside)
- external slats from all sides

NOT PAINTED

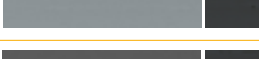
- elements from inside
- floor boards
- roof boards
- rafters, purlins
- all the details seen inside of the house
- foundation beams (brown dipped)



You will find available treatment options next to each product under Treatment Options section. Please get familiar with the article number and description of the treatment we offer as follows:

Art. No.	Description	Treatment
NO	Natural, untreated wood	
BNDIP	Brown dip	
GYDIP	Grey dip	
WTDIP	Clear white dip	
GNVPI	Green pressure-treated	
GYVPI	Grey pressure-treated	
BNVPI	Brown pressure-treated	
GNVPIH4	Green pressure-treated HC4	
GNVPIA	Green pressure-treated NTR-A	
WTPNT1+0	White primer	
WTPNT1+2	Primer + white painted 2 layers (RAL 9016)	
GYPNT1+2	Primer + grey painted 2 layers (RAL 7016)	
PNT7042A*	light grey + anthracite (RAL7042 + RAL7016)	
PNT7012A*	dark grey + anthracite (RAL7012 + RAL7016)	
PNT9016A*	white + anthracite (RAL9016 + RAL7016)	
PNT7042W*	light grey + white (RAL7042 + RAL9016)	
PNT7012W*	dark grey + white (RAL7012 + RAL9016)	
PNT9016W*	white + white (RAL9016 + RAL9016)	
PNT7042H*	light grey + light grey (RAL7042 + RAL7042)	
PNT7012G*	dark grey + dark grey (RAL7012 + RAL7012)	

PALMAKO ANIMATIONS OF PRODUCT CONCEPT AND INSTALLATION

Bosse

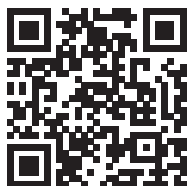

Tom 3,8 m²



Sally 15,5 m²



Ly 13,6 m²



Melanie 9,9 m²



Andre 44,7 m²



Karl 40,6 m²

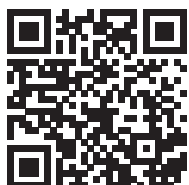

Kalle 13,5 m²

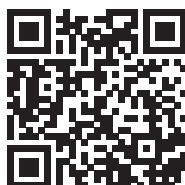

Fence panels



Terrace fence

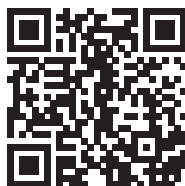

Palmako

LEMEKS GROUP

Bringing joy to the garden

Palmako AS is the leading manufacturer of garden and log houses, glue-laminated products and wood pellets. Our product range is wide: square log garden houses, garden cabins, garden sheds, pavilions, carports, tool sheds, children's playhouses, weekend and living houses. We also offer a wide choice of timber products in your garden – fence panels, posts and poles, wooden furniture and log rolls.

Catalogue models are kept in stock year-round for quick delivery throughout the world. Our products are well known for their quality because we use the best raw material available: durable and beautiful Nordic spruce. Palmako is FSC certified and products made from FSC timber have been marked accordingly.

27 years of experience in wood industry has made us one of the leading companies in this area in Europe today.



Copyright 2025 Palmako AS
All rights reserved.
Printing errors, colour errors, mistakes
and technical changes reserved.
Pictures are illustrative only.

www.palmako.ee

Over 700 high-quality wooden products
by Palmako

CONTACT RESELLER